

Tornos de Bancada

Referência	Mordente mm	Abertura mm		Preço €
Nº1 RC01000001	75	85	1	€ 65,00
Nº3 RC01000003	100	120	1	€ 96,00
Nº4 RC01000004	115	130	1	€ 124,0
Nº5 RC01000005	125	165	1	€ 146,0
Nº6 RC01000006	150	205	1	€ 203,0
Nº8 RC01000008	205	235	1	€ 316,0
TON-E* RC010000T1	100	105	1	€ 54,00

- [1] Mordentes endurecidos (substituíveis)
- [2] Alavanca de aperto em aço
- [3] Parafuso de aperto de grande resistência
- [4] Veio rectificadado
- [5] Parafuso e rosca substituíveis
- [6] Travão de segurança
- [7] Guia traseira (evita lixo e sujidade)

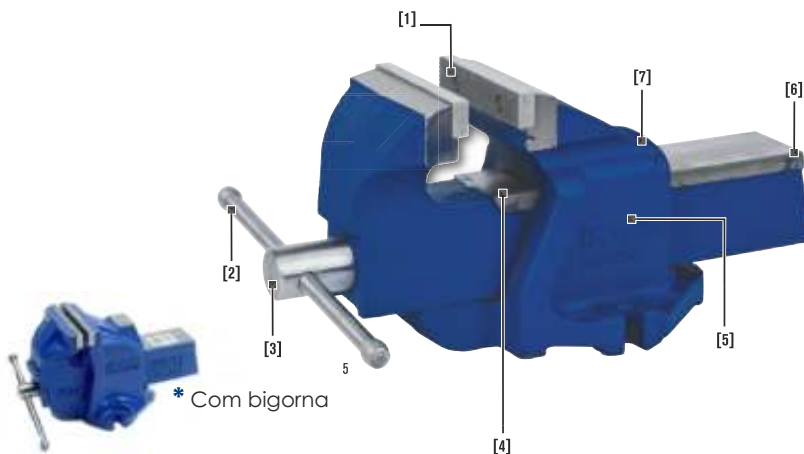

Tesouras Corte Chapa

- Corte Esquerda / Recto
- Folha de aço 1,1mm
- Folha de inox 0,6mm
- Pega ergonómica

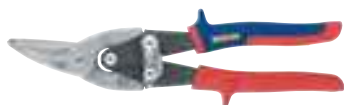

Referência	Tamanho mm	Lâmina mm		Preço €
101 PS01101000	254	33	1	€ 18,00

- Corte Frontal
- Folha de aço 1,1mm
- Folha de inox 0,6mm
- Pega ergonómica



Referência	Tamanho mm	Lâmina mm		Preço €
103 PS01103000	254	33	1	€ 18,00

- Corte Off-Set Esquerda
- Folha de aço 1,1mm
- Folha de inox 0,6mm
- Pega ergonómica



Referência	Tamanho mm	Lâmina mm		Preço €
20-SL PS01020SL0	241	33	1	€ 24,00

- Corte Direita / Recto
- Folha de aço 1,1mm
- Folha de inox 0,6mm
- Pega ergonómica



Referência	Tamanho mm	Lâmina mm		Preço €
102 PS01102000	254	33	1	€ 18,00

- Multi-corte
- Folha de aço 0,5mm
- Folha de inox 0,4mm
- Pega ergonómica



Referência	Tamanho mm	Lâmina mm		Preço €
304 PS01304000	298	80	1	€ 24,00

- Corte Off-Set Direita
- Folha de aço 1,1mm
- Folha de inox 0,6mm
- Pega ergonómica



Referência	Tamanho mm	Lâmina mm		Preço €
20-SR PS01020SR0	241	33	1	€ 24,00

Alicates Fixação

■ Dentes Rectos



Referência	Tamanho	Cap.		Preço €
7-R VG017R0000	7" - 175mm	38mm	1	€ 14,00
10-R VG0110R000	10" - 250mm	48mm	1	€ 18,50

■ Dentes Curvos



Referência	Tamanho	Cap.		Preço €
7-CR VG017CR000	7" - 175mm	38mm	1	€ 14,00
10-CR VG0110CR00	10" - 250mm	48mm	1	€ 18,50

■ Bico Longo



Referência	Tamanho	Cap.		Preço €
6-LN VG016LN000	6" - 150mm	51mm	1	€ 18,50

■ Bico Chato

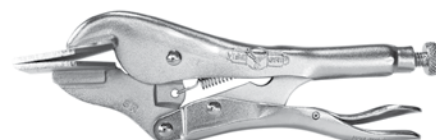

Referência	Tamanho	Cap.		Preço €
8-R VG018R0000	8" - 200mm	78mm	1	€ 24,00

■ Tipo U



Referência	Tamanho	Cap.		Preço €
9-R VG019R0000	9" - 225mm	70mm	1	€ 27,50

■ Corrente



Referência	Tamanho	Cap.		Preço €
20-R VG0120R000	9" - 225mm	455mm	1	€ 36,50

■ Dentes Curvos ■ Com corta fios



Referência	Tamanho	Cap.		Preço €
5-WR VG015WR000	5" - 125mm	29mm	1	€ 12,00
7-WR VG017WR000	7" - 175mm	38mm	1	€ 14,00
10-WR VG0110WR00	10" - 250mm	48mm	1	€ 18,50

■ Dentes Curvos



Referência	Tamanho	Cap.		Preço €
6-R VG016R0000	6" - 150mm	54mm	1	€ 16,00
11-R VG0111R000	11" - 275mm	102mm	1	€ 26,00
18-R VG0180R000	18" - 455mm	190mm	1	€ 35,00