

basic^k

■ Xacto com lâmina fixa.

Referência		Peso g		Preço €
8031-3 ZT01803110	1	140	10	€ 2,95



Confortável
· Desenho ergonómico.



 **8002-0** (60x19x0,65mm)

basic^k

■ Xacto com lâmina retráctil.

Referência		Peso g		Preço €
8041-3 ZT01804110	1	170	10	€ 4,20



Confortável
· Desenho ergonómico.



Prático
· Avanço de lâmina suave.
· Sistema de mola.



 **8002-0** (60x19x0,65mm)

basic^k

■ Xacto automático.

Referência		Peso g		Preço €
8141-3 ZT01814130	1	185	10	€ 6,00



Confortável
· Desenho ergonómico.



Seguro
· Sistema de retorno automático.



 **8002-0** (60x19x0,65mm)

eos

■ Xacto automático.

Referência		Peso g		Preço €
8751-3 ZT01875130	1	200	10	€ 5,00



Confortável
· Desenho ergonómico.



Seguro
· Sistema de retorno automático.
· Sistema interlock.



Versátil
· Depósito para lâminas.



Rápido
· Abertura fácil.



 **8002-0**
(60x19x0,65mm)

eos

■ Xacto automático.

Referência		Peso g		Preço €
8780-1 ZT01878010	1	235	12	€ 6,00



Confortável
· Desenho ergonómico.



Seguro
· Sistema interlock.



Rápido
· Abertura fácil.



 **8982-1**
(140x19x0,90mm)

Xactos



8002-0
(60x19x0,65mm)

- Confortável**
· Desenho ergonómico.
- Versátil**
· Depósito para lâminas.
- Rápido**
· Abertura fácil.
- Inovador**
· Encaixe magnético de lâminas.

■ Xacto profissional com coldre.

Referência		Peso g		Preço €
8981-5 ZT01898150	1	305	1	€ 10,95



8008-0
(18 mm)

- Confortável**
· Desenho ergonómico.
- Versátil**
· Depósito para lâminas.
· Inclui 2x lâminas extra.
- Seguro**
· Com bloqueio de lâmina.
- Inovador**
· Sistema de recarregamento automático da lâmina.

■ Xacto de lâmina segmentada.

Referência		Peso g		Preço €
8713-1 ZT01871310	3	230	6	€ 10,70



8007-0 (9 mm)

- Versátil**
· Depósito para lâminas.
· Inclui 2x lâminas extra.
- Seguro**
· Com bloqueio de lâmina.
· Protecção de segurança na ponta.
- Prático**
· Quebra lâminas no topo.

■ Xacto de lâmina segmentada.

Referência		Peso g		Preço €
8703-1 ZT01870310	3	45	30	€ 3,95

■ Lâminas de substituição.

Referência	Lâminas	Dimensões mm	Pcs.		Preço €
8002-0 ZT01800220		60x19x0,65	5	100	€ 0,80
8007-0 ZT01800700		9	10	100	€ 1,65
8008-0 ZT01800800		18	10	100	€ 2,45
8982-1 ZT01898210		140x19x0,9	2	50	€ 3,60

Corta Tubos

basic+

■ Corta tubos para tubos de metal (espessura máx. 2mm).

Referência	Ø mm		Peso g		Preço €
7016-1 ZT02701610	3 - 16	1	110	10	€ 8,40



- Rápido**
· Sistema ICS (troca de rodízio rápida).
- Confortável**
· Desenho ergonómico.
- Inovador**
· Raio de trabalho reduzido.
- Resistente**
· Rosca de ajuste em aço.



basic+

■ Corta tubos para tubos de metal (espessura máx. 2mm).

Referência	Ø mm		Peso g		Preço €
7030-1 ZT02703010	3 - 30	1	350	5	€ 10,40



- Rápido**
· Sistema ICS (troca de rodízio rápida).
- Confortável**
· Desenho ergonómico.
- Resistente**
· Rosca de ajuste em aço.

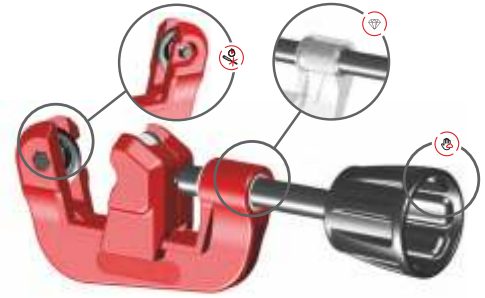

basic+

■ Corta tubos para tubos de metal (espessura máx. 2mm).

Referência	Ø mm		Peso g		Preço €
7036-1 ZT02703610	3 - 35	1	395	5	€ 15,30



- Rápido**
· Sistema ICS (troca de rodízio rápida).
- Confortável**
· Desenho ergonómico.
- Inovador**
· Raio de trabalho reduzido.
- Resistente**
· Rosca de ajuste em aço.

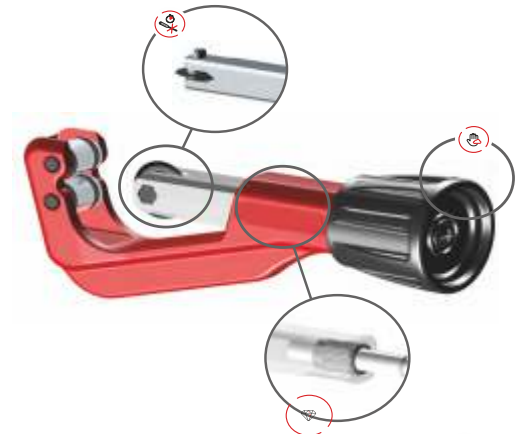

kompakt+

■ Corta tubos para tubos de metal (espessura máx. 2mm).

Referência	Ø mm		Peso g		Preço €
7135-1 ZT02713510	3 - 35	2x	345	3	€ 22,40



- Resistente**
· Rosca de ajuste em aço.
- Rápido**
· Sistema ICS (troca de rodízio rápida).
- Confortável**
· Desenho ergonómico.
- Inovador**
· Raio de trabalho reduzido.
- Preciso**
· Com 4 roletes.
- Prático**
· Rebarbador NOGA destacável.
- Versátil**
· Depósito para rodízios.



kompakt+

■ Corta tubos para tubos de metal (espessura máx. 2mm).

Referência	Ø mm		Peso g		Preço €
7476-1 ZT02747610	6 - 76	2x	905	1	€ 43,00



- Inovador**
· Sistema de liberação rápida.
- Rápido**
· Sistema ICS (troca de rodízio rápida).
- Confortável**
· Desenho ergonómico.
- Preciso**
· Com 4 roletes.
- Prático**
· Rebarbador NOGA destacável.
- Versátil**
· Depósito para rodízios.



Corta Tubos

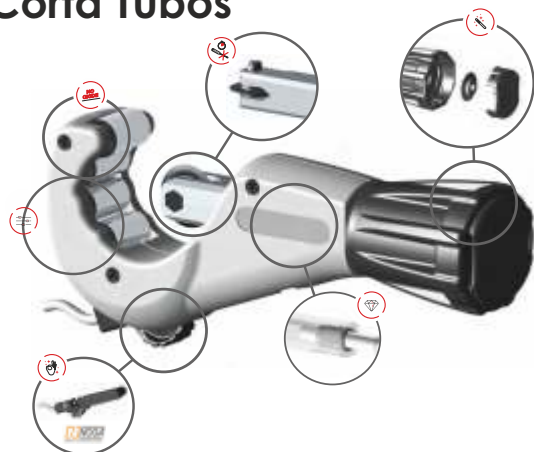

6001-8
19x5mm

Referência	Ø mm		Peso g		Preço €
7235-1 ZT02723510	3 - 35	2x	345	3	€ 31,00
7245-1 ZT02724510	3 - 45	2x	365	3	€ 34,00



Resistente

· Rosca de ajuste em aço.



Rápido

· Sistema ICS(troca de rodízio rápida).



Preciso

· Com 4 roletes.



Prático

· Rebarbador NOGA destacável.



Versátil

· Depósito para rodízios.



Inoxidável

· Roletes em inox .

inox kompakt+

■ Corta tubos para tubos de inox (espessura máx. 2,5mm).

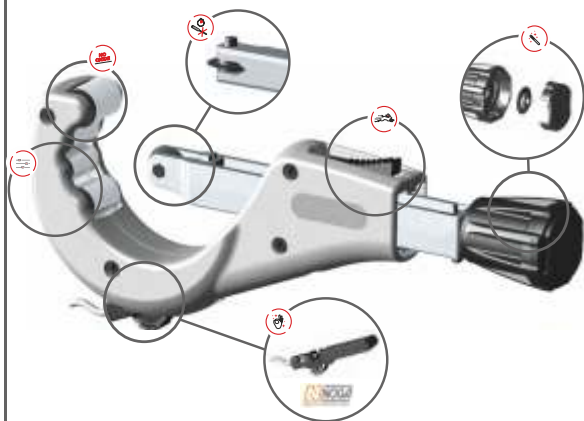

6005-8
19x6,2mm

Referência	Ø mm		Peso g		Preço €
7576-1 ZT02757610	6 - 76	2x	905	1	€ 54,00



Inovador

· Sistema de liberação rápida.



Rápido

· Sistema ICS(troca de rodízio rápida).



Preciso

· Com 4 roletes.



Prático

· Rebarbador NOGA destacável.



Versátil

· Depósito para rodízios.



Inoxidável

· Roletes em inox .

maxtc

■ Corta tubos para tubos de aço e inox (espessura máx. 7mm).

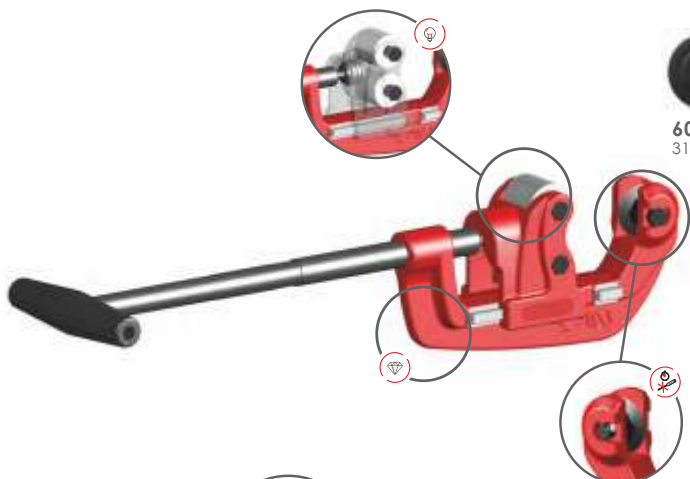

6002-0
31x19mm

Referência	Ø mm		Peso g		Preço €
6050-1 ZT02605010	10 - 60	1x	2250	1	€ 59,00



Inovador

· Roletes com amortecedor, para melhor corte e maior durabilidade da lâmina.



Resistente

· Corpo em aço forjado.



Rápido

· Sistema ICS(troca de rodízio rápida).



6015-0
41x28mm

Referência	Ø mm		Peso g		Preço €
6054-1 ZT02605410	60 - 114	1x	7600	1	€ 168,0



Rápido

· Sistema ICS(troca de rodízio rápida).



Inovador

· Roletes com amortecedor, para melhor corte e maior durabilidade da lâmina.



Versátil

· Com barra auxiliar.

■ Rodízios para corte de metal.

Referência		mm		Preço €
6001-0 ZT02600100	19x5,0	2	1	€ 1,35
6005-0 ZT02600500	19x6,2	2	1	€ 1,40



■ Rodízios para corte de inox.

Referência		mm		Preço €
6001-8 ZT02600180	19x5,0	2,5	1	€ 2,50
6005-8 ZT02600580	19x6,2	2,5	1	€ 2,70

Rodízios

■ Rodízios para corte de aço e inox.

Referência		mm		Preço €
6002-0 ZT02600200	31x19	7	1	€ 3,50
6015-0 ZT02601500	41x28	10	1	€ 6,80



raptor

■ Para tubos plásticos e multicapa.

Referência	Ø mm	Peso g		Preço €
5026-1 ZT05502610	26	250	4	€ 21,00



Íficiente

· Corte fácil rápido e preciso.



Rápido

· Sistema ICS(troca rápida de lâmina).



Qualidade

· Lâmina em inox com revestimento PTFE.



Prático

· Retorno de lâmina automático.

raptor

■ Para tubos plásticos e multicapa.

Referência	Ø mm	Peso g		Preço €
5035-1 ZT05503510	35	285	4	€ 28,00



Íficiente

· Corte fácil rápido e preciso.



Rápido

· Sistema ICS(troca rápida de lâmina).



Qualidade

· Lâmina em inox com revestimento PTFE.



Prático

· Retorno de lâmina automático.



Seguro

· Retorno de lâmina interior.

raptor

■ Para tubos plásticos e multicapa.

Referência	Ø mm	Peso g		Preço €
5050-1 ZT05503510	50	480	6	€ 42,00



Íficiente

· Corte fácil rápido e preciso.



Rápido

· Sistema ICS(troca rápida de lâmina).



Qualidade

· Lâmina em inox com revestimento PTFE.



Prático

· Retorno de lâmina com uma mão.



Seguro

· Retorno de lâmina interior.

Alicates Corta Tubos



+ PTFE



+ PTFE



+ PTFE



Alicates Corta Tubos

denakut

■ Para manguieras flexíveis.

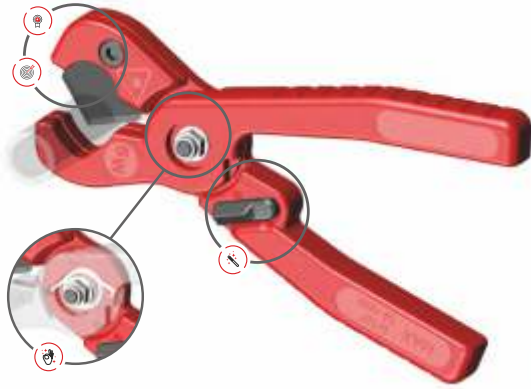

PTFE +



5014-1
ZT05501410



eficiente

· Corte fácil rápido e preciso.



Versátil

· Aloquete acionado a uma mão.



Qualidade

· Lâmina com revestimento PTFE.



Prático

· Retorno de lâmina automático.

Referência	Ø mm	Peso g		Preço €
5014-1 ZT05501410	14	90	6	€ 16,00

denakut

■ Para manguieras flexíveis.

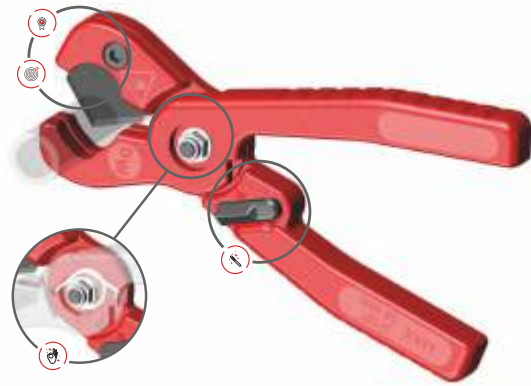

PTFE +



5022-1
ZT05502210



eficiente

· Corte fácil rápido e preciso.



Versátil

· Aloquete acionado a uma mão.



Qualidade

· Lâmina com revestimento PTFE.



Prático

· Retorno de lâmina automático.

Referência	Ø mm	Peso g		Preço €
5022-1 ZT05502210	22	90	5	€ 18,00

denakut

■ Para manguieras flexíveis, tubos de plástico macio e de parede delgada.

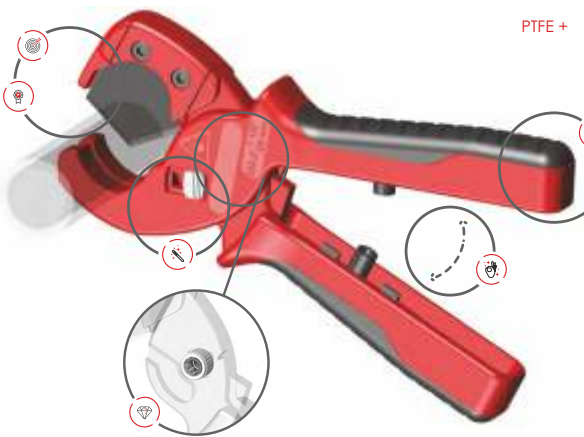

PTFE +



5028-1
ZT05502810



eficiente

· Corte fácil rápido e preciso.



Versátil

· Aloquete acionado a uma mão.



Qualidade

· Lâmina com revestimento PTFE.



Prático

· Retorno de lâmina automático.



Resistente

· Sistema de alavanca com quadra em aço e rolamento de agulhas.



Confortável

· Manipulos em borracha.
· Batentes com absorção de impacto.

Referência	Ø mm	Peso g		Preço €
5028-1 ZT05502810	28	230	5	€ 25,00

denakut

■ Para tubos multicapa.

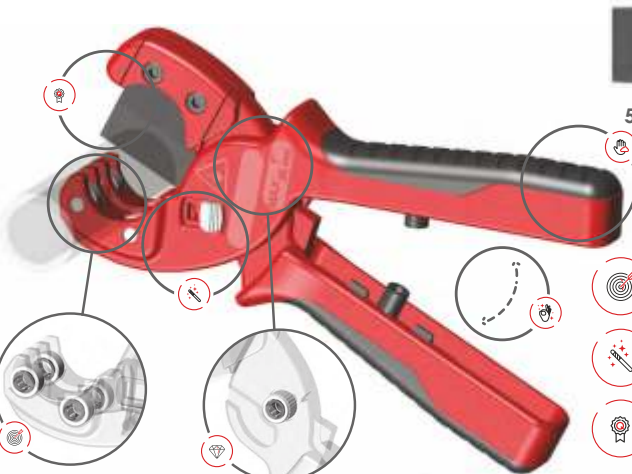

+ PTFE



5226-1
ZT05522610



eficiente

· Com 4 roletes, fazem com que o tubo rode aliviando tensão no corte.



Versátil

· Aloquete acionado a uma mão.



Qualidade

· Lâmina com revestimento PTFE.



Prático

· Retorno de lâmina automático.



Resistente

· Sistema de alavanca com quadra em aço e rolamento de agulhas.



Confortável







· Manipulos em borracha.
· Batentes com absorção de impacto.

Referência	Ø mm	Peso g		Preço €
5226-1 ZT05522610	26	250	5	€ 27,00

denakut +

■ Para tubos multicapa.

Referência	Ø mm	Peso g		Preço €
5126-1 ZT05512610	26	285	5	€ 35,00

-  **eficiente**
· Com 4 roletes, fazem com que o tubo rode aliviando tensão no corte.
-  **Versátil**
· Alicate acionado a uma mão.
-  **Qualidade**
· Lâmina com revestimento PTFE.
-  **Prático**
· Retorno de lâmina automático.
-  **Resistente**
· Sistema de alavanca com quadra em aço e rolamento de agulhas.
-  **Confortável**
· Manipulos em borracha.
· Batentes com absorção de impacto.





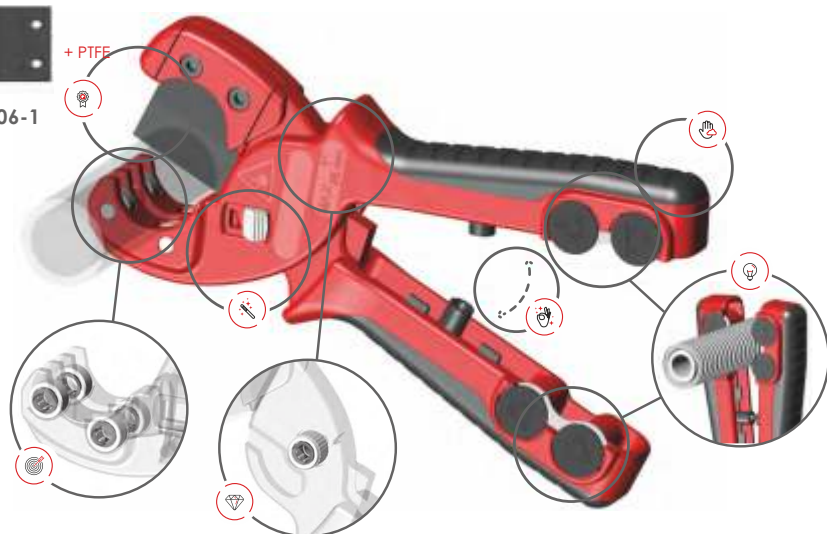





5006-1



-  **Inovador**
· Sistema de corte de protecção de tubo, sem danificar tubo interior.
· Com 4 lâminas de 3 gumes com revestimento PTFE.



■ Lâminas de substituição para alicates corta tubos.

Referência	Lâminas		Preço €
5005-1 ZT05500510		1	€ 7,50
5001-1 ZT05500110		1	€ 12,00
5003-1 ZT05500310		1	€ 16,00
5009-1 ZT05500910		1	€ 7,70

Referência	Lâminas		Preço €
5011-1 ZT05501110		1	€ 8,50
5007-1 ZT05500710		1	€ 9,00
5006-1 ZT05500610		1	€ 9,00

■ Chaves de lavabos .

Referência	mm 	Peso g		Preço €
6200-1 ZT03620010	240	180	6	€ 18,50

-  **Versátil**
· Gancho pode ser colocado à esquerda ou à direita.
-  **Resistente**
· Chave e gancho em aço cromo-vanadio.

■ Prumos.

Referência		Peso g		Preço €
8080-1 ZT04808010		200	10	€ 4,75

Alicates Corta Tubos

Ferramenta Diversa



CHROM-VANADIUM



Traçadores de Rectas



basic_k

■ Traçador de rectas + Pó azul 60g.

Referência		Peso g		Preço €
8153-1 ZT04815310	15m	180	6	€ 6,59



Versátil

· Gancho temperado, com pontas dobradas, para prender em arestas.



Qualidade

· Saída do cordel protegida com anilha de aço.



squid

■ Traçador de rectas.

Referência		Peso g		Preço €
8091-1 ZT04809110	15m	165		€ 7,90



Inovador

· Sistema PUSH: permite recolher o fio sem ter de rodar a manivela.



Preciso

· Laterais planas, para poder apoiar o traçador na superfície a marcar.



Versátil

· Gancho temperado, com pontas dobradas, para prender em arestas.



Qualidade

· Saída do cordel protegida com anilha de aço.



Prático

· Com clip em inox.



Referência	Peso g		Preço €
8066-1 ZT04806610	250	6	€ 2,20
8068-1 ZT04806810	500	35	€ 3,20