



TENGTTOOLS[®]
Catálogo
2024

Representante Exclusivo
MONTENEGRO, FERNANDES & C.^a, S. A.

Get organised™

Catálogo 2024

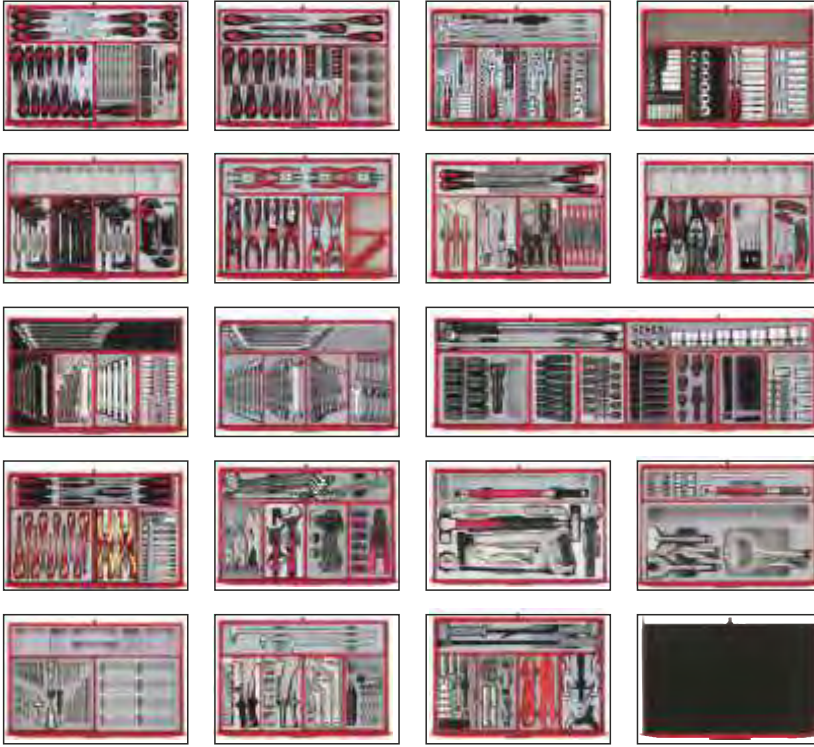

n° TengTools	n° TengTools
TTD914N	TTX2032
TTMD74	TTX2640
TTMD12D	Tt3592
TTX918N	TTRORS
TTD912TXN	TT6506
TTMI16	TTBS35
TT01	TTX3404
TTXMDTN	TTX3414
TT1435	TT9112TX
TT3819	TT9207
TT1205	TT9024
TT1217	TT9015HX
TTXEXT13	TTD9416
TTAF32	TTBE18
TT1215AF	TT9116
TT1211	TTV440
TT3816	TTDV910N
TTX00	TTHEX23
TTHEX7	TTXMDN
TTHEX7AF	TTVG05
TTHT28	TTADJ04
TTTX7	TTCP121
TTX03	TTCP04
TTD441-T	TTX6311
TT474-7	TTPS09
TT00	TTX1292
TTX474-9	TTSPG
TTTM03	TTX3892
TTBM	TTDTD34
TTSR04	TTD01
TTNF12	TTX01
TTXF05	TTNR81
TTDCT05	TTHR81
TTK40	TTID20
TTPC09	TTHP08
TTX03	TTXPB3
TT1236	TTOS16
TT6508R	TTSN11
TT6208	TT804
TT6010M	TTHC03
	TTXPB3A



TC-MONSTER02 | € 9.095,00

Mega Master Kit

Kit de ferramenta com 1185 peças.
Carro TWC809N e Báu TC810N





- n° TengTools
- TTXEXT13
- TT1435
- TT3819
- TT1205
- TT1217
- TTX474-9
- TT440-T
- TTVG05
- TTDCT05
- TTXF05
- TTTTX30
- TTBS35
- TTTTXH15
- TTRS15
- TTX2640
- TTAF32
- TT1215AF
- TT3592
- TT3816
- TTX918N

- n° TengTools
- TT917N
- TT917TXN
- TTMD74
- TTDB28
- TTX2032
- TT1236
- TT6508R
- TT6208
- TT474-7
- TTX3404
- TTHT28
- TTHEX7
- TTTTX7
- TTTTM08
- TTX3414
- TT9207
- TT9120DN
- TTID20
- TTBM



TCMM-IND08 | € 4.230,00

Kit de ferramenta com 569 peças.
Carro TCW809N com topo em madeira.

- n° TengTools
- TTX23
- TTX6311
- TTX2032
- TTTHR81
- TTDCT05
- TTZ01
- TTXMDTN
- TT6010M
- TTX918N
- TTX3404
- TT1435
- TT1217
- TT3592
- TT474-5E
- TTXEXT13
- TTX2640
- TTTD17
- TT1205
- TT917N
- TT6508RF
- TTX3414
- TT9015HX
- TTCP121
- TTV440
- TTNR81
- TTSD38
- TTXND
- TT6506
- TT3819
- TTMD74
- TT65608R
- TTX3892
- TTTTXH15
- TTHEX23
- TTM116
- TTPC09

- n° TengTools
- TTPS09
- TT474-7E
- TTSN11
- TTSR04
- TT1236
- TTXPB3A
- TTV907N
- TTHEX7AF
- TT804-06
- TTOS16
- TTHC03
- TTD441
- TTID20
- TTID19
- TT1215AF
- TTZVG03
- TTTTM03
- TTAF32
- TTX1292
- TTTTX7
- TTHP08
- TTHEX7
- TT474-9E
- TTTTX30
- TT917TXN
- TT9116N
- TTXF05

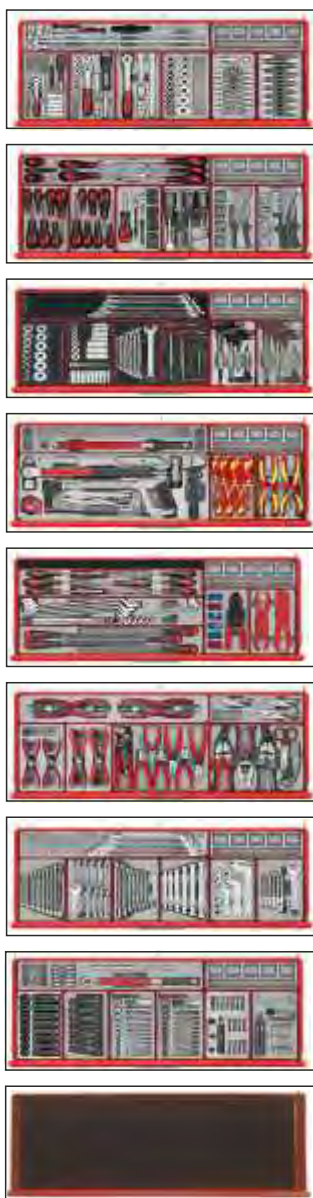

TCMM-1034N | € 6.400,00

Kit de ferramenta com 1034 peças.
Carro TWC207N e Báu TC205NF



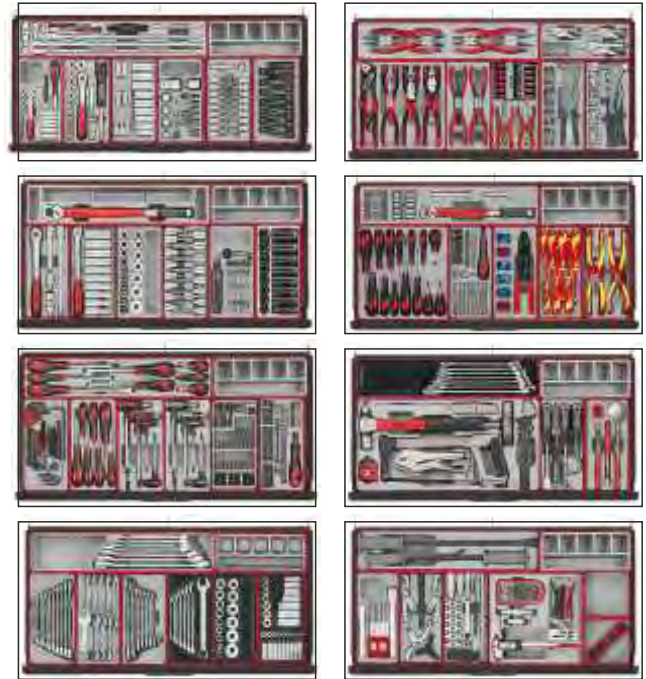
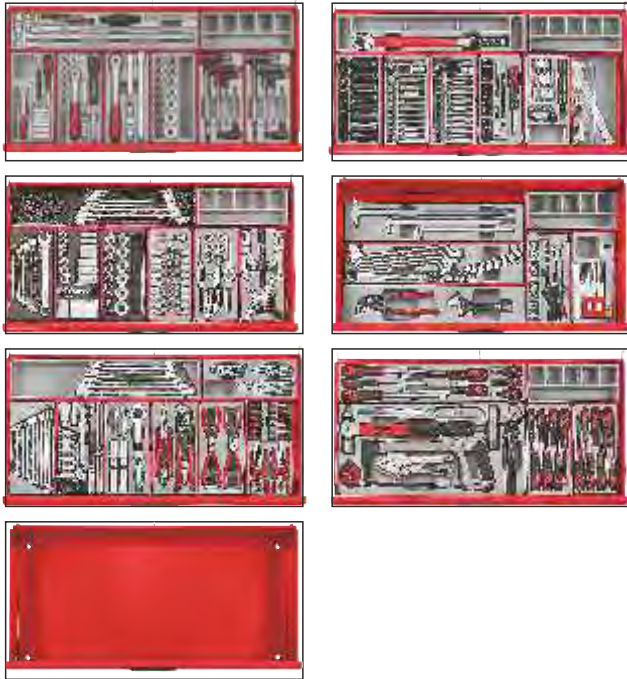

n° TengTools	n° TengTools
TTXEXT13	TT804
TT1435	TTZ01
TT3819	TTX918N
TT1217	TTPS09
TT1205	TT917N
TTHEX7	TT917TXN
TTTTX7	TTZ01
TTZ01	TTX1292
TTX2032	TT9116N
TT1236	TTHEX23
TTSN11	TTALU
TTOS16	TTTTX23
TTMI16	TTID20
TT474-7	TTMD74
TT440	TTZ01
TTZVG03	TTX6311
TTX2640	TTXPB3
TT3592	TTXMB02
TTAF32	TTNR81
TT1215AF	TTPC09
TTTTX30	TTZ01
TTTTD17	

n° TengTools	n° TengTools	n° TengTools
TBS35	TTV440	TTPS09
TTX2032	TTNR81	TTSR04
TTHR81	TT3819	TT1236
TTZ01	TT6508R	TTXPB3A
TT6010M	TTX3892	TT804
TTX918N	TTMI16	TTV907N
TTMDR84	TTPC09	TTHT28
TT1435	TTOS16	TTHEX7
TT3592	TTID20	TTTTX30
TTXEXT13	TT474-7	TT917TXN
TT3816	TT1215AF	TT9116N
TTX2640	TTZVG03	TTD914N
TT1205	TTTTM03	
TT00	TTX474-9	
TTADP17	TT1211	
TT9015HX	TTD441-T	
TT1217-6	TTAF32	
TTMDQ49	TTX1292	
TTDCM	TTHEX16	
TTCP121	TTTTX7	



TCMM-622N | € 3.375,00

Kit de ferramenta com 622 peças.
Carro TCW207N com topo em madeira.



TCMM-1004NBK1 | € 5.085,00

Kit de ferramenta com 1004 peças.
Carro TCW208NBK1 com topo em madeira,
Torno e Suporte pº rolos de papel (não incluído).





- n° TengTools
- 1476NTX1
- 1477NX
- 587H
- TT1435
- TT3819
- TT1218
- TT1211
- TT1236
- TT6010M
- TT6508RS
- TTADJ04
- TTHEX7
- TTTX7
- TTHT28
- TT804
- TTD441-T
- TT474-7
- TTM16
- TTCP04
- TTCP121
- TTV440
- TTV907N
- TTTTF10
- TTK40
- TTDCT05
- TTD914N
- TT917TXN
- TTMD74
- TTX918N
- TTHR81
- TTNR81
- TTSD39
- TTBE18
- TTX1292
- TTVG05
- TTID20
- TTPC09
- TTNF12
- TTXEXT13
- TTAF32
- TT1215AF
- TTBM
- TTTTM08
- TTXTB09
- TTTXH15
- TTTTX30
- TTTRS15
- TTBS35
- TTX2032
- TT9024
- TT9207
- TT9116N
- TTTS08
- TTXPB3
- 583M
- TM149
- 9850
- DB034
- 580
- TCW-SP01



TCMM-1055N | € 5.355,00

Kit de ferramenta com 1055 peças.
Baú topo TC806NF
Baú intermédio TC803N
Carro TCW807N.





TCMM-1001N | € 5.245,00

Kit de ferramenta com 1001 peças.
Baú superior TC806NF,
Baú intermédio TC803N,
Carro TCW810N.



TCMM-1001BK

€ 5.245,00

Kit de ferramenta com 1001 peças.
Baú superior TC806NGM,
Baú intermédio TC803NBK,
Carro TCW810NBK.

n° TengTools

TM708
 1479MM
 1479AF
 1479TX
 TTHEX7
 TTNR81
 TTTX7
 TTHR81
 TT1236
 TTALU
 TTTMO3
 TT6208
 TTPS09
 TTPC09
 TTID20
 TTSR04
 TT00
 TTHP08
 TT6506
 TT6010M
 TT3592
 TTXPB3
 TTX6311
 TTXEXT13
 TT1205
 TT1435
 TT3819
 TT1217
 TTTX23
 TTHEX23
 TTALU
 TTXMDTN
 TT9116N
 TTX918N

n° TengTools

TT917N
 TT917TXN
 TTMD74
 TTMI16
 TTX474-9
 TT440-T
 TT474-7
 TT474-5
 TTHC03
 TTX1292
 TTV440
 TTCP121
 TTV907N
 TT01
 TTX01
 TT804
 TTOS16
 TTSN11
 TTTD17
 TTX2032
 TTX3892
 TTXPB3A
 TTXMDN
 TTPSPG
 TTX2640
 TTTXH15
 TT1215AF
 TTAF32
 TTTX30
 TTX3404
 TTX3414
 ABS-TOP
 580



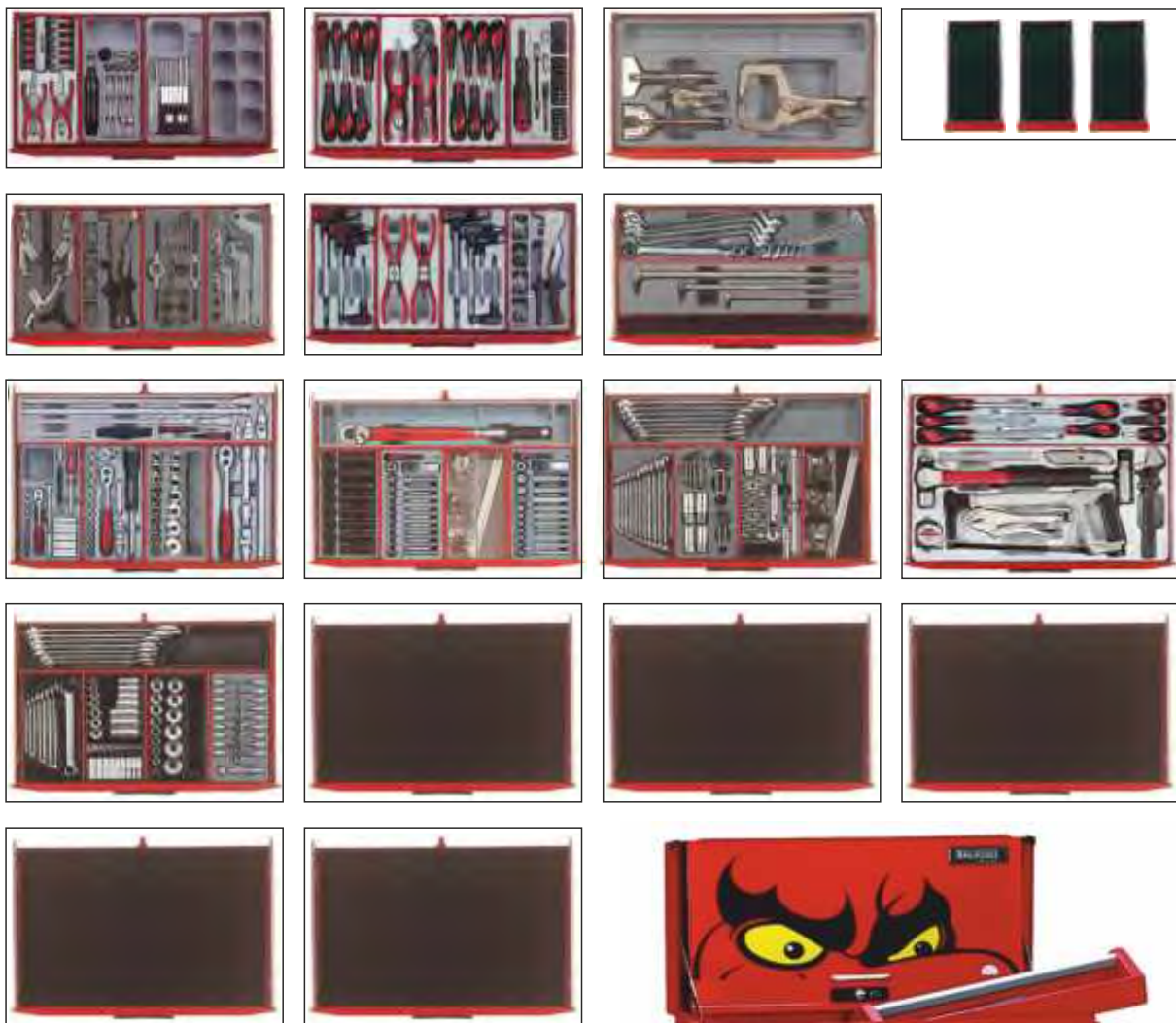

nº TengTools

- TTMI16
- TTID20
- TTPC09
- TT01
- TT917N
- TT440-T
- TT917TXN
- TTMD74
- TTPSPG
- TT804
- TTNR81
- TTTD17
- TTHP08
- TTHEX7
- TT474-7
- TTTX7
- TTHR81
- TTX6311
- TTXPB3
- TTXEXT13
- TT1435
- TT3819
- TT1217
- TT1205
- TTX1292
- TT9116N
- TTHEX23
- TTALU

nº TengTools

- TTTX23
- TTX2032
- TT1236
- TTSN11
- TTOS16
- TTALU
- TTX918N
- TTPS09
- TTX2640
- TT3592
- TTAF32
- TT1215AF
- TTTX30



TCMM-715N | € 3.925,00

Kit de ferramenta com 715 peças.
Baú superior TC806NF,
Baú intermédio TC803N
Carro TCW810N.



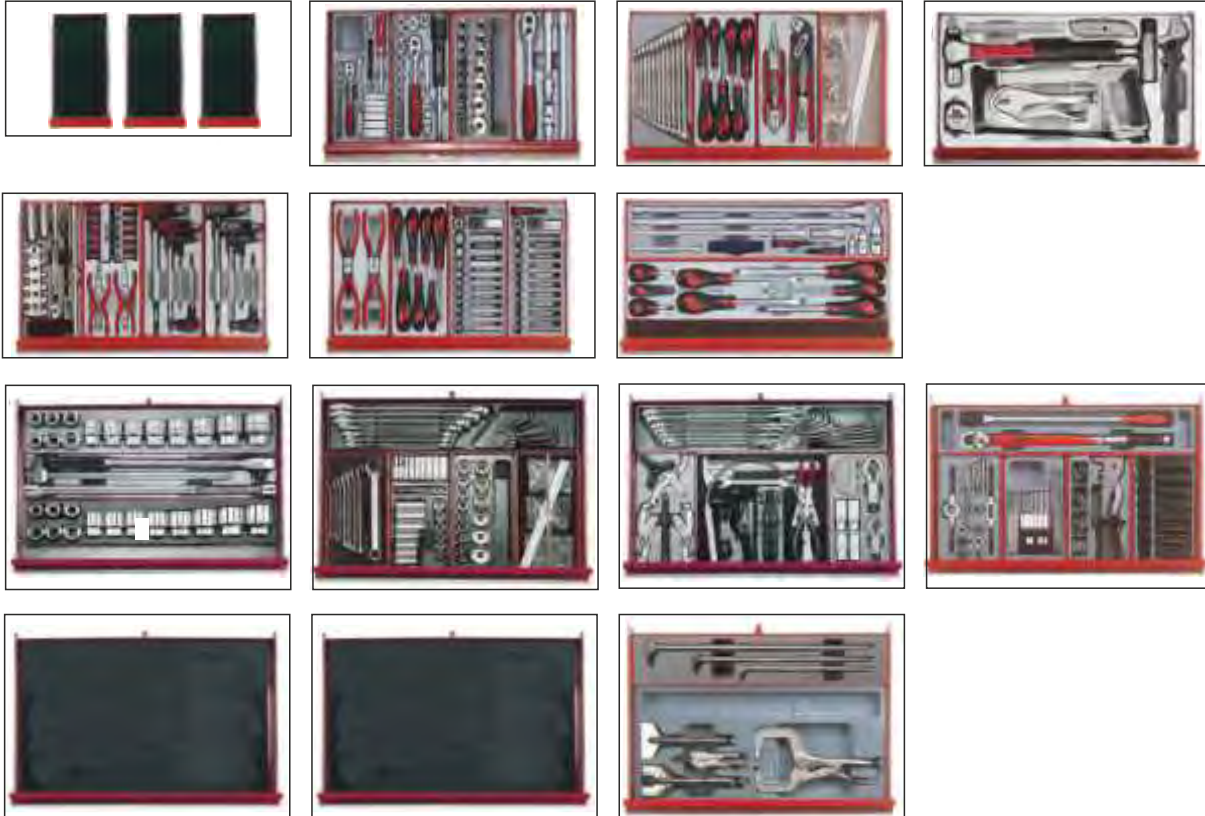

TCMM-600 | € 4.395,00

Kit de ferramenta com 600 peças.
Baú superior TC806NF,
Baú intermédio TC803N
Carro TCW807N.

nº TengTools

- TT1435
- TT3819
- TT1217
- TT1205
- TT1236
- TT917N
- TT440
- TTALU
- TTPS09
- TTXEXT13
- TTX918N
- TTOS16
- TTMI16
- TTHEX7
- TTTX7
- TT474-7
- TT917TXN
- TTHEX23
- TTTX23
- TTX2032
- TT804
- TTSN11
- TTX1292
- TTTD17
- TTPC09
- TTHR81
- TT9116N
- TTXPB3
- TTPSPG
- TTX2640
- TT3592
- TTAF32
- TT1215AF
- TTALU
- TTX3414
- TTX3404
- TTX34AF
- TCW-SP

TCMM-479 | € 3.395,00

Kit de ferramenta com 479 peças.
Baú superior TC806NF,
Baú intermédio TC803N
Carro TCW807N.
Igual ao **TCMM600** menos o painel lateral TCW-SP e menos 6 tabuleiros de ferramentas.

nº TengTools

- TT1435
- TT3819
- TT1217
- TT1205
- TT1236
- TT917N
- TT440
- TTALU
- TTPS09
- TTXEXT13
- TTX918N
- TTOS16
- TTMI16
- TTHEX7
- TTTX7
- TT474-7
- TT917TXN
- TTHEX23
- TTTX23
- TTX2032
- TT804
- TTSN11
- TTX1292
- TTTD17
- TTPC09
- TTHR81
- TT9116N
- TTXPB3
- TTPSPG

1/7





- n° TengTools
- TTXEXT13
- TT1435
- TT3819
- TT1218
- TTTXH15
- TTXMDTN
- TTMD74
- TT917TXN
- TTHEX7
- TTTX7
- TTXMDN
- TTHR81
- TT474-7
- TT804
- TT01
- TTX00
- TTPC09
- TTCP121
- TTDTD34
- TTX2032
- TTDCT05
- TTTM08
- TTBM
- TTX01
- TTPS09E

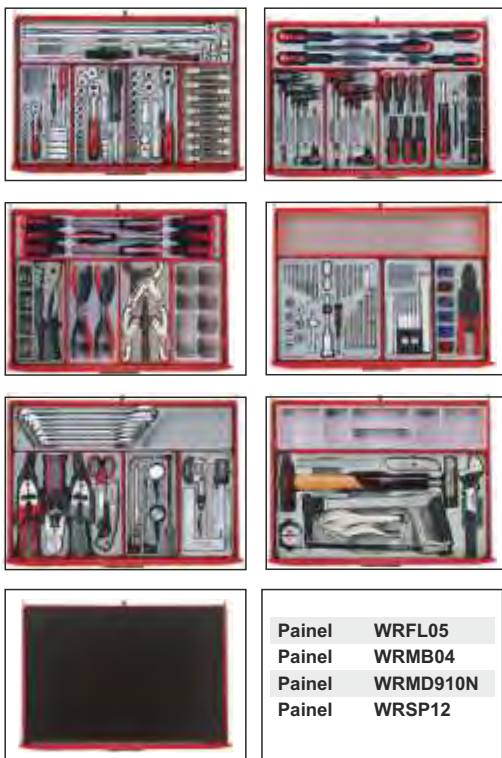

TCMM-545N | € 2.980,00

Kit de ferramenta com 545 peças.
Carro TCW807N,
Painel TC-S01
Tampo em madeira TC-TB02.

- n° TengTools
- TT1205
- TT1217-6
- TT1435
- TT3819
- TTXEXT13
- TT01
- TT917N
- TT917TXN
- TTMD74
- TTXMDTN
- TT01
- TTCP121
- TTHEX7
- TTHR81
- TTX00
- TTHT28
- TTMD12D
- TTNF12
- TTSR04
- TTXF05
- TT1236
- TT440-T
- TT474-7
- TT6208
- TTX2032
- TT804
- TTALU
- TTPC09
- TTTXH15
- TTXMDN
- TTPS09
- TTX01



TCMM-546N | € 2.310,00

Kit de ferramenta com 546 peças.
Carro TCW808N.



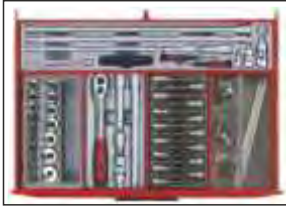
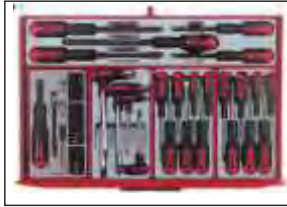

- nº TengTools
- TTXMDN
- TT1435
- TT3819
- TT1236
- TT6208
- TTXMDTN
- TTMD74
- TTHEX7
- TT917N
- TT917TXN
- TTX00
- TT440-T
- TTPC09
- TTCP121
- TTTX7
- TTX01
- TTPS09
- TTXEXT13
- TT1217
- TT1205
- TTTXH15
- TTALU
- TTX2032
- TTHR81
- TT804
- TT474-7
- TT01



TCMM-491N | € 2.195,00

Kit de ferramenta com 491 peças.
Carro de 7 gavetas TCW807N.



- nº TengTools
- TT1435
- TT3819
- TT1217
- TT1205
- TT1236
- TT917N
- TT440-T
- TTALU
- TTPS09

TC-8140NF | € 930,00

Kit de ferramenta com 140 peças.
Baú de topo TC806NF.



TM-035NF | € 255,00

Kit de ferramenta com 35 peças.
Mini baú de 275mm.

Chaves ¼ 4, 5, 5.5, 6, 7, 8, 10, 12, 13mm
 Acc. ¼ extensão 2", chave bits, adaptador hexagonal
 Bits hex. fenda 4, 5.5, 6.5mm, Ph¹, Ph², Pz¹, Pz², Tx¹⁰, Tx¹⁵, Tx²⁰
 Chave crescente 4"

Alicate de corte lateral 6" e alicate universal 7"

Chaves boca/luneta 8, 9, 10, 11, 12, 13mm
 Chaves de fendas 5.5 x 75, Ph1 x 75mm
 Chave 1000v Ph1 x 80mm





Protecção

Use lonas Teng Tools para manter as caixas limpas e protegidas.

Segurança

Use fixadores Teng Tools na união de carros e baús (TCF01, TCF02).

Mantenha o peso distribuído

Distribua as ferramentas pelas gavetas consoante o peso e guarde a ferramenta pesada nas gavetas inferiores.

Manutenção

Lubrifique as correções e rolamentos das gavetas regularmente.

Reparação e manutenção

Substitua as peças de desgaste periodicamente.



Sobrecarga

Nunca sobrecarregue as suas gavetas.

Utilização

Não utilize as caixas de ferramenta como escadas.

Uso consciente

Não abra mais que uma gaveta de cada vez, o excesso de gavetas abertas pode tombar o armário.

Transporte

Garanta que todos os componentes e ferramenta estão devidamente acondicionados.



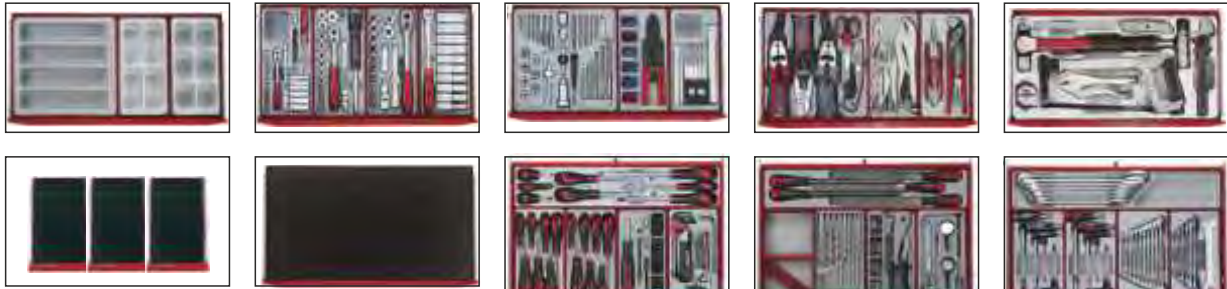

- n° TengTools
- TTDCT05
- TT440
- TTVG05
- TTPC09
- TTCP121
- TTDTD34
- TTPS09
- TT1435
- TT3819
- TT1218
- TT1211
- TT03
- TT04
- TTD00
- TTD01
- TTD02
- TTX03
- TT1236
- TT6208
- TTHEX7
- TTTX7
- TTX2032
- TTDB28
- TT00
- TTHR81
- TTTM08
- TTXF05
- TTMD74
- TT917N
- TT917TXN
- TTHT28
- TTX918N



TCMM-569EV | € 2.790,00

Kit de ferramenta com 569 peças.
Baú superior TC806SV,
Baú intermédio TC803SV
Carro TCW707EV.



- n° TengTools
- TT1435
- TT3819
- TT1211
- TT1218
- TTXEXT13
- TT1236
- TT6208
- TTHEX7
- TTTX7
- TTX2032
- TT440
- TTVG05
- TTDCT05
- TTX1292
- TTMD74
- TT917N
- TT917TXN
- TTHT28
- TTX918N

TCMM-277EV | € 1.785,00

Kit de ferramenta com 277 peças.
Carro TCW707EV.



- n° TengTools
- TT1236
- TT917N

TC-820SV | € 385,00

Kit de ferramenta com 20 peças.
Baú de topo TC806SV.





- n° TengTools
- TEDV909N
- TESSD14
- TEXEXT13
- TEDHT42
- TTEISK33
- TEXFLS06
- TEX1238
- TTESK85
- TEXPB4
- TTESP37
- TTEVG11
- TEDIMM
- TEABS5
- TTBE18
- TEXTB05
- TEXMDNT
- TEA01
- TEXW05
- TTEPS12
- TTESK86
- TTEISK73
- TTEMB17
- TTEX23N
- TEAMDQ78
- TEDPC14
- TEAHR81
- TEDDF7
- TTESK32
- TTESP31
- TTESK63
- TEDV440
- TEDADJ4
- TTEAF62
- TTEMD122N

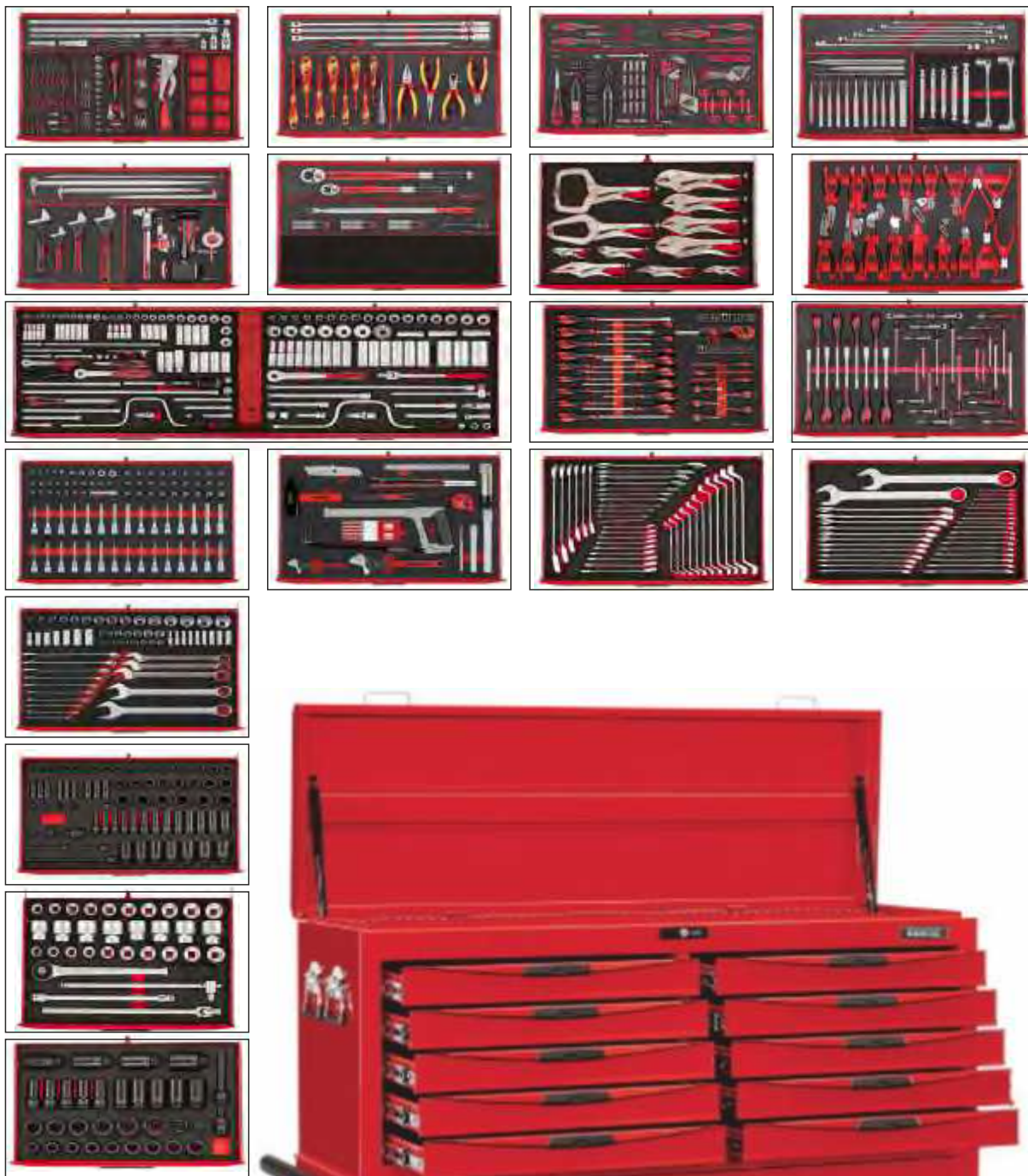

TCE-MM117N | € 10.895,00

Mega Master Kit EVA

Kit de ferramenta com 1117 peças.
Carro TWC809N e Báu TC810N



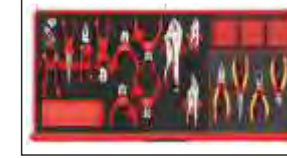

- nº TengTools
- TTESK77
- TEDHT42
- TEZ01
- TTEX32
- TEZ01
- TED1489
- TTEMD122N
- TEDV909N
- TEZ01
- TTEMB11
- TEDV440
- TEZ01
- TTESK85
- TEDSD14
- TEZ01
- TTEPS12
- TEAHR81
- TEABS50
- TEZ01



TCMME-631N | € 3.670,00

Kit de ferramentas com 631 peças
Carro TCW207N com topo em madeira



TCMME-846N | € 6.965,00

Kit de ferramenta com 846 peças.
Carro TWC207N e Báu TC205NF

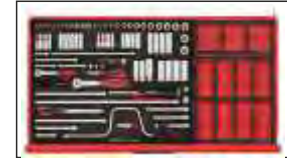
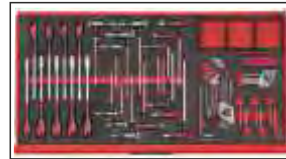

- nº TengTools
- TEDV909N
- TEDSD14
- TEX6308
- TEDHT42
- TEX1238
- TTESK85
- TEXPB4
- TEDIMM
- TED6512R
- TTEPS12
- TTESK86
- TED01
- TEZ01
- TTEMB17
- TTEX23N
- TEAVSD09
- TED9121
- TEAHR81
- TEDDF7
- TTESK32
- TTESP31
- TTESK63
- TEDV440
- TTEAF62
- TTEMD122N





- n° TengTools
- TTESK86
- TTESK63
- TTESK32
- TTESP31
- TTEMD122N
- TTEMB14Q
- TTESK73
- TTEISK33
- TTEX23
- TTEVG11
- TTESP37

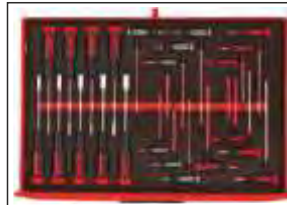
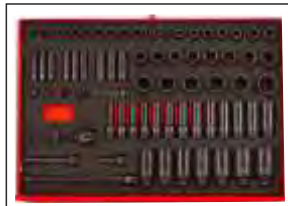
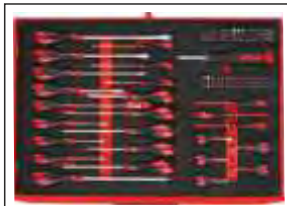



TCMME-09AQ | € 5.610,00

Kit de ferramenta EVA com 527 peças.
Baú TC805NFX e Carro TCW806N1.

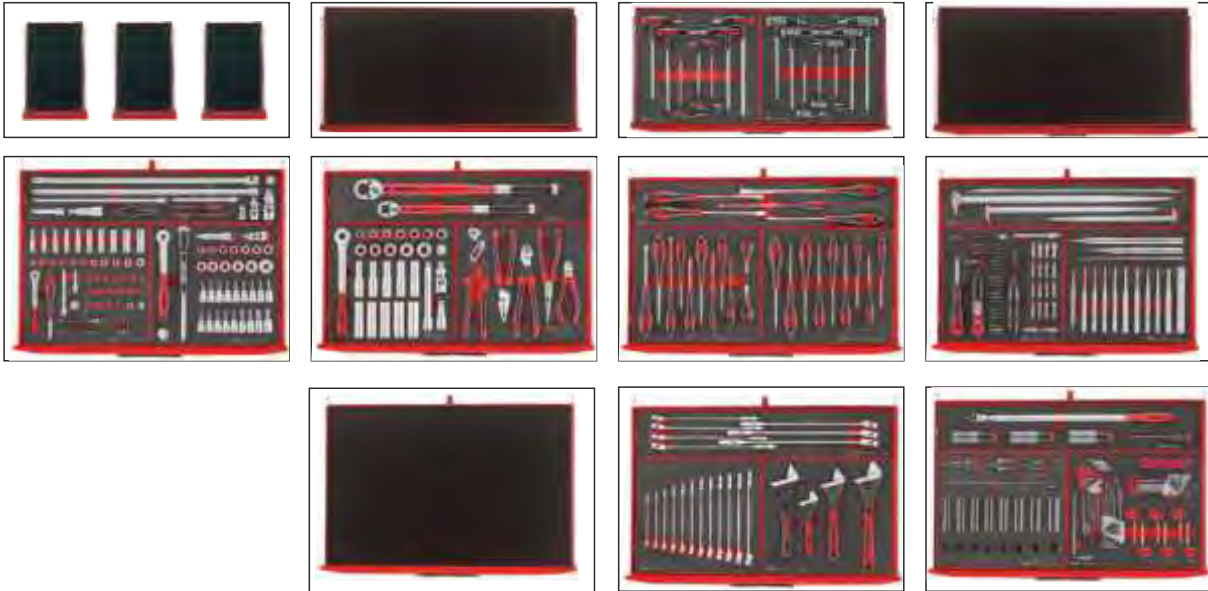





- nº TengTools
- TEDHEX7
- TEDTX7
- TEXEXT13
- TED1489
- TED3836
- TEX1238
- TED1227
- TED441-T
- TEX915N
- TED911N
- TED909TXN
- TEXPB4
- TEDSD14
- TEDPC14
- TEX2032
- TED8012
- TEDADJ4
- TEXW05
- TED9121
- TEDHT42

1 ESCOLHE LOCAL DE ARMAZENAGEM
para todas as necessidades.



2 ESCOLHE OS TEUS KITS
O teu kit, à tua maneira.



3 ORGANIZA O TEU KIT
Optimiza a teu gosto.

TCMME-417N | € 3.130,00

Kit de ferramenta com 417 peças.
 Baú superior TC806NF
 Baú intermédio TC803N
 Carro de 7 gavetas TCW807N.





- n° TengTools
- TEDV440
- TEDV909N
- TEDHEX7
- TEDTX7
- TEXEXT13
- TED1489
- TED3836
- TEX1238
- TED1227
- TED441-T
- TEX915N
- TED911N
- TED909TXN
- TEX2032
- TED8012
- TEDADJ4

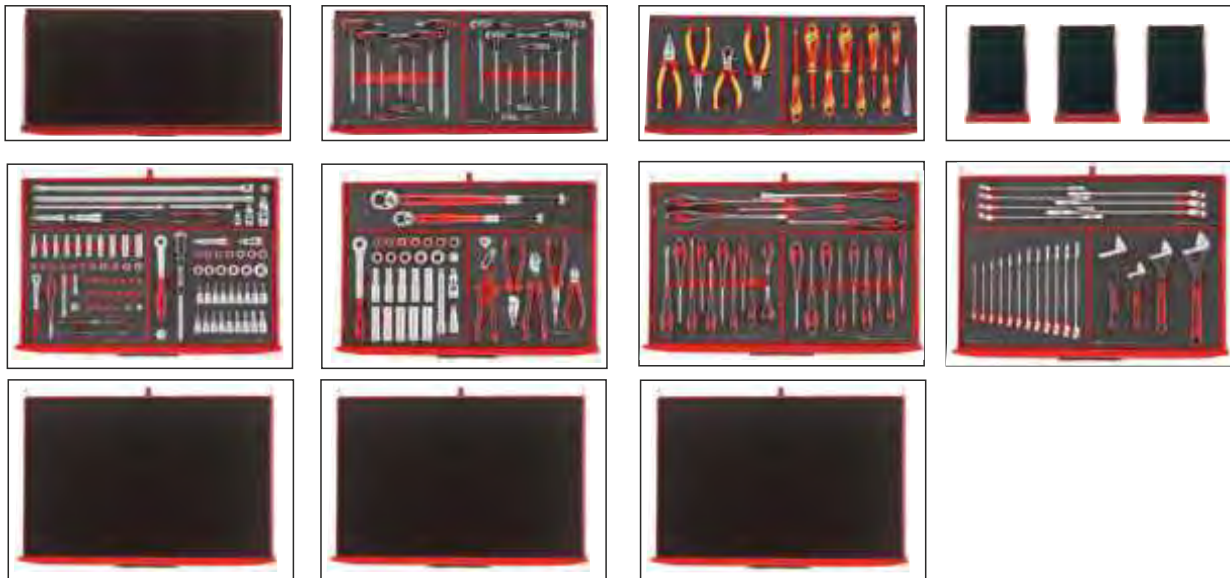

TENGTOOLS

**FLEXIBILIDADE
NO LOCAL
DE TRABALHO**

POUPA TEMPO E DINHEIRO
COM O NOSSO SISTEMA DE CONTROLO

Get organised®

- Maximizar a eficiência
- Maior sustentabilidade e menor consumo
- Proporciona um ambiente de trabalho mais seguro

TCMME-249N | € 2.555,00

Kit de ferramenta com 249 peças.
Baú TC806NF
Carro TCW807N.





- n° TengTools
- TTEMB11
- TTEMD98N
- TTEPS12
- TTESK77
- TTESK85
- TTEX17
- TTEX32

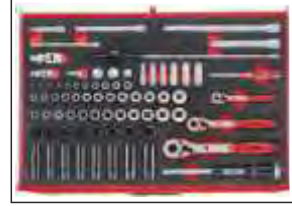

TCMME-11A | € 2.910,00
 Kit de ferramenta com 333 peças.
 Carro TCW807N.

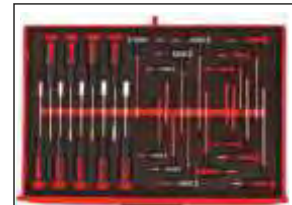

- n° TengTools
- TTESK86
- TTEMD122N
- TTESP31
- TTEMB14Q
- TTEX23



TCMME-09CQ | € 2.265,00
 Kit de ferramenta com 277 peças.
 Carro TCW807N.





n° TengTools
 TEX02 (x2)
 TED00
 TED1227
 TED1489
 TED441T
 TTEMD33



TCMME-158 | € 1.040,00

Kit de ferramenta com 158 peças.
 Carro TCW707EV.



n° TengTools E179
 TTEPS25
 TTESK126
 TTESP28

n° TengTools E174
 TTEPS15
 TTEMD33
 TTESK126
 ABS TOP

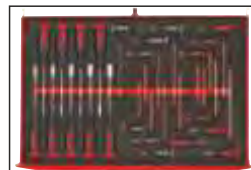

TCMME-179 | € 1.275,00

Kit de ferramenta com 179 peças.
 Carro TCW707EV.



TCMME-174 | € 1.315,00

Kit de ferramenta com 174 peças.
 Carro TCW707EV.



n° TengTools
 TTESK86
 TTEMD122N
 TTEMB14Q
 TTEX23
 TTESP31

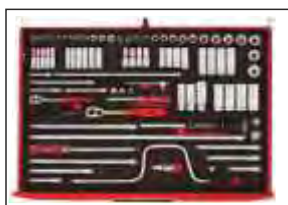

TCMME-09BQ | € 2.065,00

Kit de ferramenta com 280 peças.
 Baú TC805NFX.



**TC144D | € 780,00**

Kit de ferramenta com 144 peças.
Caixa de ferramenta metálica TC540.

**TC144E | € 760,00**

Kit de ferramenta com 144 peças.
Saco TCSB.



Acessórios	1/2"		FRP roquete, junta universal, extensão 2½" e 6", adaptador barra T 3/8"F:1/2"M
Chaves de caixa	1/2"	12 pontos	10, 11, 12, 13, 14, 15, 16, 17, 18, 19, 21, 22, 24, 27, 30, 32mm
Acessórios	1/4"		FRP roquete, junta universal, extensão 2" e 4", adaptador p ^a bits, adaptador 3/8"F:1/4"M
Chaves de caixa	1/4"	6 pontos	4, 5, 5.5, 6, 7, 8, 10, 11, 12, 13mm
Ch. de caixa longa	1/4"	6 pontos	6, 7, 8, 10, 12, 13mm
Bits	1/4" hex		TX10, TX15, TX20, hex 5, 6mm, PH1, PH2, PZ1, PZ2, fenda 4, 5.5mm
Chaves			boca/luneta 5.5, 6, 7, 8, 9, 10, 11, 12, 13, 14, 15, 16, 17, 18, 19mm, jogo chaves umbrako (bola/hex), umbrako 1.5, 2.0 e 2.5mm, chave crescente 10"
Chaves de parafusos			fenda 3.5, 5.5mm, 6.5mm, PH0, PH1, PH2, PZ0, PZ1, PZ2, 1000v fenda 4mm
Alicates			universal 8", pontas 8", bomba de água 10", corte lateral 6" e 8", fixação 10"
Ferramenta			jogo 28 brocas, lâmpada magnética, fita métrica 3m, armação de serra e serras, faca, punção de bico, jogo 6 punções de arrombar, martelo batente de borracha, martelo bola, tesoura chapa,

Contem: M120510, M120511, M120512, M120513, M120514, M120515, M120516, M125017, M120518, M120519, M120521, M120522, M120524, M120527, M120530, M120532, M140504, M140505, M1405055, M140506, M140507, M140508, M140510, M140511, M140512, M140513, M140606, M140607, M140608, M140610, M140612, M140613, 6005055, 600506, 600507, 600508, 600509, 600510, 600511, 600512, 600513, 600514, 600515, 600516, 600517, 600518, 600519, MD916N, MD922N, MD928N, MD940N, MD947N, MD948N, MD960N, MD961N, MD962N, MDV824N, M141210T, M141215T, M141220T, M141301, M141302, M141601, M141602, M141404, M1414055, 1479MM, 3105015, 310502, 3105025, 4004IQ, 1200FPR, M120030, M120020, M120023, M380036, 1400FPR, M140030, M140020, M140022, M140060, M380035, MB452-8, MB461-8, MB481-10, MB442-6, MB442-8, 401-10, DB028, 587M, MT03, 701, 702, 710N, CP05, PPS06, HMSF, HMBP16, 495, 583M.

TC187 | € 330,00

Kit de ferramenta com 187 peças.
Caixa de ferramenta metálica TC450.



Acessórios	1/4"		30 clips, roquete FRP, junta universal, extensões de 2" e 4", adaptador 3/8"F:1/4"M, adaptador
	3/8"		30 clips, roquete FRP, junta universal, extensão 6", adaptador 1/2"F:3/8"M
	1/2"		30 clips, roquete FRP, junta universal, extensão 2½" e 6", adaptador 3/8"F:1/2"M
Chaves de caixa	1/4"	6 pontos	4, 5, 5.5, 6, 7, 8, 10, 11, 12, 13mm
Ch. caixa longa	1/4"	6 pontos	6, 7, 8, 10, 12, 13mm
Chaves de caixa	3/8"	6 pontos	8, 9, 10, 11, 12, 13, 14, 15, 16, 17, 18, 19, 21, 22mm
Chaves de caixa	1/2"	12 pontos	10, 11, 12, 13, 14, 15, 16, 17, 18, 19, 21, 22, 24, 27, 30, 32mm
Bits	1/4" hex		TX8, TX10, TX15, TX20, TX25, TX27, TX30, TX40, hex 3, 4, 5, 6, 7, 8, 10mm, PH1, PH2, PZ1, PZ2, fenda 4, 5.5, 7mm.
Chaves			boca/luneta 8, 10, 11, 12, 13, 14, 15, 17, 19mm, umbrako 1.5, 2.0, 2.5mm.

Contem: M140504, M140505, M1405055, M140506, M140507, M140508, M140510, M140511, M140512, M140513, M140606, M140607, M140608, M140610, M140612, M140613, M380508, M380509, M380510, M380511, M380512, M380513, M380514, M380515, M380516, M380517, M380518, M380519, M380521, M380522, M120510, M120511, M120512, M120513, M120514, M120515, M120516, M120517, M120518, M120519, M120521, M120522, M120524, M120527, M120530, M120532, 600508, 600510, 600511, 600512, 600513, 600514, 600515, 600517, 600519, M141208T, M141210T, M141215T, M141220T, M141225T, M141227T, M141230T, M141240T, 1400FPR, M140030, M140020, M140021, M380035, M140060, 3800FPR, M380030, M380021, M120036, 1200FPR, M120030, M120020, M120023, M380036, M141503, M141504, M141505, M141506, M141507, M141508, M141510, M141301, M141302, M141601, M141602, M141404, M1414055, M141407, 3105015, 310502, 3105025.





- n° TengTools
- TT01
- TTHT28
- TT440
- TT3819
- TT1236
- TTMDQ49



TC-6T01 | € 400,00

Kit de ferramenta com 114 peças.
Mala de ferramenta com 6 tabuleiros

- n° TengTools
- TTV440
- TTVSVD09
- TTV3814
- TTDV910N
- TT04



TC-6T02 | € 520,00

Kit de ferramenta com 37 peças.
Mala de ferramenta com 5 tabuleiros



- n° TengTools
- TT1217
- TT1236
- TT440-T
- TT917N
- TT917TXN
- TTHEX7
- TT1435
- TT3819
- TT1205



SC01 | € 780,00

Kit de ferramenta com 83 peças.
Mala de ferramenta com 9 tabuleiros

- n° TengTools
- TT440
- TTMI16
- TTCP121
- TTTM03
- TTNF12
- TTDB28
- TT6508R
- TTHT28
- TTMD12D



SC02 | € 885,00

Kit de ferramenta com 232 peças.
Mala de ferramenta com 9 tabuleiros



- n° TengTools
- TT440
- TTMI16
- TTMD12D
- TT917N
- TT917TXN
- TTMD74
- TT1435
- TTBS35
- TTTM03



SC03 | € 750,00

Kit de ferramenta com 139 peças.
Mala de ferramenta com 9 tabuleiros

- n° TengTools
- TT1236
- TT917N
- TT440-T
- SCPS01
- TT1435
- TT3819
- TT1218



SC04 | € 755,00

Kit de ferramenta com 100 peças.
Mala de ferramenta com 7 tabuleiros





n° TengTools
TEFMD54
TEFMB7
TEFSK57



SC-E-1 | € 770,00

Kit de ferramenta com 118 peças.
Mala de ferramenta com 3 tabuleiros EVA



n° TengTools
TEFMDi54
TEFMBP7
TEFSK57



SC-E-2 | € 780,00

Kit de ferramenta com 118 peças.
Mala de ferramenta com 3 tabuleiros EVA



n° TengTools
TEFXV11
TEFSPV17
TEFXV27



SC-E-3 | € 1.120,00

Kit de ferramenta com 56 peças.
Mala de ferramenta com 3 tabuleiros EVA



n° TengTools
TEASD38
TED441TQ
TED8012
TED911n
TEAMDQ78
TEAHR81



SC-E-4 | € 795,00

Kit de ferramenta com 226 peças.
Mala de ferramenta com 6 tabuleiros EVA



n° TengTools
TEFXV27
TEF07A
TEFSPV17



SC-E-5 | € 1.150,00

Kit de ferramenta com 52 peças.
Mala de ferramenta com 3 tabuleiros EVA





n° TengTools
TEFMD54
TEFSK57



TC-6-TE01 | € 430,00
Kit de ferramenta com 112 peças.
Mala de ferramenta com 2 tabuleiros



n° TengTools
TEAVSD09
TEDV909N
TEDV440
TTFEA01



TC-6-TE02 | € 375,00
Kit de ferramenta com 29 peças.
Mala de ferramenta com 4 tabuleiros



n° TengTools
TEFSKV19
TEFXV17



TC-6-TE03 | € 565,00
Kit de ferramenta com 37 peças.
Mala de ferramenta com 2 tabuleiros



n° TengTools
TEDV3818
TEAVSD09
TEDV440
TEAMDV04N



TC-6-TE04 | € 560,00
Kit de ferramenta com 36 peças.
Mala de ferramenta com 4 tabuleiros



n° TengTools
TEFSPV17
TEFXV11



TC-6-TE05 | € 545,00
Kit de ferramenta com 29 peças.
Mala de ferramenta com 2 tabuleiros



n° TengTools
TEFXV27
TEFXV11



TC-6-TE06 | € 590,00
Kit de ferramenta com 99 peças.
Mala de ferramenta com 2 tabuleiros





TC-103NF | € 100,00

Mini baú com 2 gavetas, corrediças com rolamentos esféricos e tampo com cobertura frontal.



	Largura (mm)	Profundidade (mm)	Altura (mm)	Peso (Kg)
Total	275	150	146	2.9
Gaveta 1	215	130	38	-
Gaveta 2	215	130	38	-

TC-805NFX | € 595,00

Baú de topo com 5 gavetas, corrediças com rolamentos esféricos, tampo com cobertura frontal e fecho com código. Inclui tabuleiro portátil com pega em alumínio.



	Largura (mm)	Profundidade (mm)	Altura (mm)	Peso e cap. (Kg)
Total	660	460	490	44
Gaveta 1	578	380	46	25
Gaveta 2	578	380	46	25
Gaveta 3	578	380	75	25
Gaveta 4	578	380	75	25
Gaveta 5	578	380	75	25

TC-806NF | € 375,00

Baú de topo com 6 gavetas, corrediças com rolamentos esféricos, tampo com cobertura frontal e fecho com código. Inclui tabuleiro portátil com pega em alumínio.



	Largura (mm)	Profundidade (mm)	Altura (mm)	Peso e cap. (Kg)
Total	660	305	380	22
Gaveta 1	172	270	50	8
Gaveta 2	172	270	50	8
Gaveta 3	172	270	50	8
Gaveta 4	572	270	50	20
Gaveta 5	572	270	50	20
Gaveta 6	572	270	75	20

TC-205NF | € 925,00

Baú de topo 37" com 5 gavetas, corrediças com rolamentos esféricos e fecho com código.



	Largura (mm)	Profundidade (mm)	Altura (mm)	Peso e cap. (Kg)
Total	1337	455	560	101.5
Gaveta 1	576	270	75	25
Gaveta 2	576	270	75	25
Gaveta 3	576	270	75	25
Gaveta 4	576	270	75	25
Gaveta 5	576	270	75	25
Gaveta 6	576	270	75	25
Gaveta 7	576	270	75	25
Gaveta 8	576	270	75	25
Gaveta 9	576	270	75	25
Gaveta 10	576	270	75	25



TC-810N | € 1.565,00

Baú de topo 53" com 10 gavetas, corrediças com rolamentos esféricos, tampo com amortecedores e fecho com código.



	Largura (mm)	Profundidade (mm)	Altura (mm)	Peso e cap. (Kg)
Total	1337	455	560	101.5
Gaveta 1	576	270	75	25
Gaveta 2	576	270	75	25
Gaveta 3	576	270	75	25
Gaveta 4	576	270	75	25
Gaveta 5	576	270	75	25
Gaveta 6	576	270	75	25
Gaveta 7	576	270	75	25
Gaveta 8	576	270	75	25
Gaveta 9	576	270	75	25
Gaveta 10	576	270	75	25

**TC-803N | € 245,00**

Baú intermédio de 3 gavetas, corrediças com rolamentos esféricos e fecho de código.



	Largura (mm)	Profundidade (mm)	Altura (mm)	Peso e cap. (Kg)
Total	660	305	250	13,8
Gaveta 1	572	270	50	20
Gaveta 2	572	270	50	20
Gaveta 2	572	270	75	20





TCW-803N | € 595,00

Carro com 3 gavetas, corrediças com rolamentos esféricos, tampo em ABS e fecho com código.



	Largura (mm)	Profundidade (mm)	Altura (mm)	Peso e cap. (Kg)
Total	670	460	770 (656)	46,4
Gaveta 1	575	380	75	25
Gaveta 2	575	380	75	25
Gaveta 3	575	380	150	30
Comp.	610	420	250	tampo

TCW-804N | € 635,00

Carro com 4 gavetas, corrediças com rolamentos esféricos, tampo em ABS e fecho com código.



	Largura (mm)	Profundidade (mm)	Altura (mm)	Peso e cap. (Kg)
Total	670	460	777 (654)	49
Gaveta 1	575	380	75	25
Gaveta 2	575	380	75	25
Gaveta 3	575	380	75	25
Gaveta 4	575	380	312	25

TCW-806N | € 695,00

Carro com 6 gavetas, corrediças com rolamentos esféricos, tampo em ABS e fecho com código.



	Largura (mm)	Profundidade (mm)	Altura (mm)	Peso e cap. (Kg)
Total	670	400	770 (656)	59
Gaveta 1	575	380	75	25
Gaveta 2	575	380	75	25
Gaveta 3	575	380	75	25
Gaveta 4	575	380	75	25
Gaveta 5	575	380	75	25
Gaveta 6	575	380	150	30



TCW-806N1 | € 775,00

Carro com 6 gavetas, corrediças com rolamentos esféricos, tampo em ABS e fecho com código.



	Largura (mm)	Profundidade (mm)	Altura (mm)	Peso e cap. (Kg)
Total	670	460	960 (812)	61,2
Gaveta 1	575	380	75	25
Gaveta 2	575	380	75	25
Gaveta 3	575	380	75	25
Gaveta 4	575	380	75	25
Gaveta 5	575	380	75	25
Gaveta 6	575	380	312	25

**TCW-807N | € 800,00**

Carro com 7 gavetas, corrediças com rolamentos esféricos, tampo em ABS e fecho com código.



	Largura (mm)	Profundidade (mm)	Altura (mm)	Peso e cap. (Kg)
Total	670	460	950 (813)	64
Gaveta 1	575	380	75	25
Gaveta 2	575	380	75	25
Gaveta 3	575	380	75	25
Gaveta 4	575	380	75	25
Gaveta 5	575	380	75	25
Gaveta 6	575	380	150	30
Gaveta 7	575	380	150	30

**TCW-907X | € 905,00**

Carro de 7 gavetas com amortecedor (ao fechar a gaveta os últimos centímetros de entrada são amortecidos evitando o bater da gaveta), corrediças com rolamentos esféricos, tampo em ABS e fecho com código.



	Largura (mm)	Profundidade (mm)	Altura (mm)	Peso e cap. (Kg)
Total	670	460	950 (813)	64
Gaveta 1	575	380	75	25
Gaveta 2	575	380	75	25
Gaveta 3	575	380	75	25
Gaveta 4	575	380	75	25
Gaveta 5	575	380	75	25
Gaveta 6	575	380	150	30
Gaveta 7	575	380	150	30





TCW-808N | € 845,00

Carro com 8 gavetas, corredeiras com rolamentos esféricos, tampo em ABS e fecho com código.



	Largura (mm)	Profundidade (mm)	Altura (mm)	Peso e cap. (Kg)
Total	670	460	955 (813)	61
Gaveta 1	576	380	75	25
Gaveta 2	576	380	75	25
Gaveta 3	576	380	75	25
Gaveta 4	576	380	75	25
Gaveta 5	576	380	75	25
Gaveta 6	576	380	75	25
Gaveta 7	576	380	75	25
Gaveta 8	576	380	154	25

TCW-810N | € 900,00

Carro com 10 gavetas, corredeiras com rolamentos esféricos, tampo em ABS e fecho com código.



	Largura (mm)	Profundidade (mm)	Altura (mm)	Peso e cap. (Kg)
Total	670	460	950 (813)	69
Gaveta 1	575	380	50	25
Gaveta 2	575	380	50	25
Gaveta 3	575	380	50	25
Gaveta 4	575	380	50	25
Gaveta 5	575	380	50	25
Gaveta 6	575	380	50	25
Gaveta 7	575	380	75	25
Gaveta 8	575	380	75	25
Gaveta 9	575	380	75	25
Gaveta 10	575	380	150	30

TCW-207N | € 1.040,00

Carro 37" com 7 gavetas, corredeiras com rolamentos esféricos, topo com tapete de borracha e fecho com código.



	Largura (mm)	Profundidade (mm)	Altura (mm)	Peso e cap. (Kg)
Total	953	460	960 (767)	82
Gaveta 1	860	380	75	40
Gaveta 2	860	380	75	40
Gaveta 3	860	380	75	40
Gaveta 4	860	380	75	40
Gaveta 5	860	380	75	40
Gaveta 6	860	380	150	40
Gaveta 7	860	380	150	40



TCW-806LN | € 2.040,00

Carro 53" com 6 gavetas, corrediças com rolamentos esféricos, fecho com código, quatro rodas pivô de 6" (150mm) duas com travão. Inclui tampo de madeira.



	Largura (mm)	Profundidade (mm)	Altura (mm)	Peso e cap. (Kg)
Total	1350	460	937 (767)	121
Gaveta 1	1216	380	75	40
Gaveta 2	1216	380	75	40
Gaveta 3	1216	380	75	40
Gaveta 4	1216	380	75	40
Gaveta 5	1216	380	75	40
Gaveta 6	1216	380	75	40

**TCW-809N | € 2.085,00**

Carro 53" com 9 gavetas, corrediças com rolamentos esféricos, fecho com código, quatro rodas pivô de 6" (150mm) duas com travão. Inclui tampo de madeira.



	Largura (mm)	Profundidade (mm)	Altura (mm)	Peso e cap. (Kg)
Total	1350	460	937 (767)	136
Gaveta 1	1216	380	75	40
Gaveta 2	575	380	75	25
Gaveta 3	575	380	75	25
Gaveta 4	575	380	75	25
Gaveta 5	575	380	75	25
Gaveta 6	575	380	75	25
Gaveta 7	575	380	75	25
Gaveta 8	575	380	150	25
Gaveta 9	575	380	150	25

**TCW-814N | € 3.490,00**

Carro 67" com 13 gavetas, corrediças com rolamentos esféricos, fecho com código, quatro rodas pivô de 6" (150mm) duas com travão. Inclui tampo de madeira.



	Largura (mm)	Profundidade (mm)	Altura (mm)	Peso e cap. (Kg)
Total	1700	460	974/1153	174
5 Gavetas	576	380	75	25
1 Gaveta	576	380	154	25
1 Gaveta	576	380	312	25
3 Gavetas	288	380	75	25
2 Gavetas	288	380	154	25
1 Gaveta	1567	380	120	40
1 Gaveta	576	380	230	tampo





TC-805SV | € 540,00

Baú de topo com 5 gavetas, corrediças com rolamentos esféricos, tampo com cobertura frontal e fecho de chave.



	Largura (mm)	Profundidade (mm)	Altura (mm)	Peso e cap. (Kg)
Total	660	460	490	44
Gaveta 1	578	380	46	25
Gaveta 2	578	380	46	25
Gaveta 3	578	380	75	25
Gaveta 4	578	380	75	25
Gaveta 5	578	380	75	25

TC-806SV | € 290,00

Baú de topo com 6 gavetas, corrediças com rolamentos esféricos, tampo com cobertura frontal e fecho de chave.



	Largura (mm)	Profundidade (mm)	Altura (mm)	Peso e cap. (Kg)
Total	660	305	380	22
Gaveta 1	172	270	50	8
Gaveta 2	172	270	50	8
Gaveta 3	172	270	50	8
Gaveta 4	572	270	50	20
Gaveta 5	572	270	50	20
Gaveta 6	572	270	75	20

TC-803SV | € 205,00

Baú intermédio de 3 gavetas, corrediças com rolamentos esféricos e fecho de chave



	Largura (mm)	Profundidade (mm)	Altura (mm)	Peso e cap. (Kg)
Total	660	305	250	13,8
Gaveta 1	572	270	50	20
Gaveta 2	572	270	50	20
Gaveta 2	572	270	75	20

TCW-707EV | € 630,00

Carro com 7 gavetas, corrediças com rolamentos esféricos e fecho de chave.



	Largura (mm)	Profundidade (mm)	Altura (mm)	Peso e cap. (Kg)
Total	670	460	950 (813)	64
Gaveta 1	575	380	75	25
Gaveta 2	575	380	75	25
Gaveta 3	575	380	75	25
Gaveta 4	575	380	75	25
Gaveta 5	575	380	75	25
Gaveta 6	575	380	150	30
Gaveta 7	575	380	150	30

Informação adicional:

Baús com terminaçãoSV = fechadura com chave, pegas laterais sem protecção, gavetas sem tapetes borracha e sem tabuleiro portátil.

Carros com terminação .. EV = fechadura com chave, pegas laterais sem protecção, gavetas sem tapetes borracha, sem top abs.



TC-816LNSTACK | € 3.600,00

Kit 2 módulos composto por TC810N e TCW806LN.

**TCW-819STACK | € 6.645,00**

Kit 2 módulos composto por TC810N e TCW809N.

**TC-816STACK | € 1.415,00**

Kit 3 módulos composto por TC806NF, TC803N e TCW807N.

**TC-816SV | € 1.125,00**

Kit 3 módulos composto por TC806SV, TC803SV e TCW707EV.

**TC-803NBK | € 245,00**

Baú intermédio de 3 gavetas, corrediças com rolamentos esféricos e fecho de código.

**TC-806NBK | € 375,00**

Baú de topo personalizável com 6 gavetas, corrediças com rolamentos esféricos, tampo com cobertura frontal e fecho com código. Inclui tabuleiro portátil com pega em alumínio.

**TCW-810NBK | € 905,00**

Carro de 10 gavetas, corrediças com rolamentos esféricos e fecho de código.

**TCW-208NBK1 | € 1.085,00**

Carro de 10 gavetas, corrediças com rolamentos esféricos e fecho de código.

TC-819NBK | € 1.520,00

Armário de 19 gavetas, composto TC806NBK, baú intermédio TC803NBK e carro TCW810NBK.





TCW-CAB | € 110,00

Armário com 1 gaveta e fecho com chave, para uso individual ou como módulo lateral em carro TengTools. (382 x 795 x 460mm, 33Kg)



TCW-CAB01 | € 530,00

Armário com fecho de código, para uso individual ou como módulo lateral em carro TengTools. (382 x 795 x 460mm, 33Kg)



TCW-CAB02 | € 425,00

Armário com 1 gaveta e fecho com código, para uso individual ou como módulo lateral em carro TengTools. (382 x 795 x 460mm, 33Kg)



TCW-CAB03 | € 335,00

Armário com fecho de código, para uso individual ou como módulo lateral em carro TengTools. (382 x 795 x 460mm, 33Kg)



TCW-CAB04 | € 260,00

Armário de 3 prateleiras, para uso individual ou como módulo lateral em carro TengTools. (382 x 795 x 460mm, 10.5Kg)



TCW-D3 | € 85,00

Módulo tipo caixa de ferramenta para fixar na lateral de carro de ferramenta TengTools. Com dois compartimentos de 460x90x50mm e um de 460x90x110mm.



TC-TMC | € 72,00

Suporte com duas rodas fixas e duas pivô com travão, para baús de topo e intermédios. (3.5Kg)



TC-SMC | € 65,00

Suporte para armários TCW-CAB01, TCW-CAB02 e TCW-CAB03, com duas rodas fixas e duas pivô com travão. (382 x 460, 3.4Kg)



TR-070 | € 410,00

Carro, 2 prateleiras, 1 gaveta. 932mm x 700mm x 450mm



TR-135 | € 600,00

Carro, 2 prateleiras, 1 gaveta. 932mm x 1339mm x 450mm



TC-SC | € 265,00

Mala de ferramenta vazia, para 9 tabuleiros TT ou 6 tabuleiros TT + SCPS01.
Pega telescópica, rodas em borracha. (527x385x197mm 6.5Kg)

**TC-3 | € 23,00**

Mala de ferramenta vazia, para 3 tabuleiros TT.
Com fechos click lock e pés em borracha.

**TC-4 | € 45,00**

Mala de ferramenta vazia, para 4 tabuleiros TT.
Com fechos click lock. Pode ser usada como uma mochila, inclui alças.

TC4SBL | 17,00

Alças para mala TC-4.

**TC-6T | € 67,00**

Mala de ferramenta vazia, para 6 tabuleiros TT.
Com fechos click lock e pés em borracha.

**TC-SB | € 90,00**

Mochila pª ferramenta, para levar as costas, ombro ou em mão.
Feita em polyester com base em borracha EVA.
(430 x 380 x 230mm 1.29Kg)

**TC-SB16 | € 95,00**

Saco pª ferramenta, para ombro ou em mão.
(410 x 280 x 300mm 2.9Kg)

**TC-450 | € 87,00**

Caixa de ferramenta metálica. Inclui tapete, tabuleiro, pés em borracha e 3 carris de alumínio + 30 clips de 1/4", 3/8" e 1/2".

**TC-P445C | € 42,00**

Caixa de ferramenta plástica. Inclui tabuleiro.
(445 x 240 x 202mm, 2.3Kg)





TC-540 | € 122,00

Caixa de ferramenta metálica de qualidade profissional, com 5 compartimentos individuais, furação para aloquete e cantos dobrados para maior segurança. (530 x 220 x 350mm, 7.3Kg)

TC540W | 10,00

Roda pª TC540



TC-A05 | € 26,00

Tabuleiro com pega em alumínio e fundo com tapete de borracha. (202 x 476 x 80mm, 0.5Kg)



TC-MAG | € 29,00

Calha magnética para ferramenta. Pode ser afixada em carro, caixa de ferramenta ou na parede. Ideal para pendurar ferramenta enquanto trabalha. (457 x 52 x 17mm, 0.6Kg).



TC-DIVL | € 5,80

Conjunto divisórias com 4 peças, para aplicar em gavetas de carro de ferramenta (compatível com gaveta funda de TC805NFX).

2x(570 x 40 x 3mm). 2x(375 x 40 x 3mm).



TC-WSP | € 85,00

Painel lateral com pega e suporte, para uso individual ou em lateral de carro TengTools.



ABS-TOP | € 20,00

Topo em ABS para carros TengTools, com base para apoiar baú e compartimentos individuais para ferramenta.



TC-MAT | € 14,50

Tapete anti-deslizante para colocar no fundo de gavetas, compartimentos e caixas de ferramenta. Fornecido em rolo de 2m, o tapete tem largura de 45cm e 2mm de espessura.



TC-DIVS | € 5,20

Conjunto divisórias com 4 peças, para aplicar em gavetas de baús intermédios e de topo.

2x(570 x 40 x 3mm). 2x(272 x 40 x 3mm).



TC-WSP01 | € 79,00

Painel lateral para carro TengTools. (805 x 460 x 25mm, 6.5Kg).



Tinas Plásticas Magnéticas

Tinas que podem ser facilmente instaladas em qualquer superfície plana de metal ferroso. Ideais para carros de ferramentas TengTools.

	Diâmetro (mm)	Preço
580-Q	112	€ 12,50
580-R	150	€ 17,00



Tinas Metálicas Magnéticas

Tina magnética, com ímanes revestido a borracha para não danificar superfícies com pintura. Para colocar parafusos, porcas, pinos, etc... Ideais para carros de ferramenta TengTools.

nºStock	Medidas mm	Preço
580	150x150	€ 15,00
580-S	270x270	€ 47,00
580-A	280x114x65	€ 36,00



Tabuleiros / Prateleiras Magnéticas

Tabuleiros que podem ser facilmente instalados em qualquer superfície plana de metal ferroso. Ideais para carros de ferramenta TengTools.

	Largura (mm)	Profundidade (mm)	Altura (mm)	Preço
580-K	230	98	136	€ 49,00
580-M	460	98	136	€ 54,00
580-N	640	98	136	€ 65,00

	Largura (mm)	Profundidade (mm)	Altura (mm)	Preço
580-J	410	90	10	€ 52,00

	Largura (mm)	Profundidade (mm)	Altura (mm)	Preço
580-CK	230	98	136	€ 43,00
580-CM	460	98	136	€ 50,00
580-CN	640	98	136	€ 63,00

	Largura (mm)	Profundidade (mm)	Altura (mm)	Preço
580-C	310	115	31	€ 35,00
580-D	210	115	31	€ 32,00



TC-ATP | € 49,00

Prateleira lateral p^a máquinas electricas.

TC-ATV | € 82,00

Prateleira lateral p^a colocação torno.



TC-A01 | € 86,00

Prateleira lateral. Inclui suporte p^a rolo (não incluído)





TC-F01 | 6,30

Fixadores para baú intermédio.
Para unir baú intermédio a carro.



TC-F02 | 6,30

Fixadores para baú de topo.
Para unir baú de topo a carro.



TC-F03 | 40,00

Fixadores para baú de topo de 53".
Para unir baú de topo a carro.



TC-DSH | 12,50

Conjunto de duas pegas para baús de topo e intermédios.



TCRFH | 42,00

Pega de substituição para carro de ferramenta.



Tampo em Madeira para Carros de Ferramenta



	Comp. (mm)	Profundidade (mm)	Espessura (mm)	Para:	Preço
TC-TB02	672	460	37	TCW803N, TCW804N, TCW806N, TCW806N1, TCW807N, TCW808N, TCW810N, TCW707EV, TCW907X	€ 113,00
TC-TB03	948	460	18	TCW207N	€131,00
TC-TB01	1354	460	37	TCW806LN, TCW809N	€216,00



Ganchos para Painéis de Ferramenta



	Ganchos	Preço
TCW-HK10	7 x 90°, 3 x 45° simples	€ 13,50
TCW-HK02	10 duplos	€ 15,50
TCW-HK03	4 x 45° simples, 4 x 45° duplos, 4 x 90° simples, 4 clip pequeno e 4 clip grande clips	€ 23,00
TCW-HK20	6 x 90°, 6 x 45° duplos	€ 27,00
TCW-HK45	10 x 45° simples	€ 14,00
TCW-HK90	10 x 90° simples	€ 13,00
TCW-HKAIR	10 ganchos para ferramenta	€ 10,00
TCW-HKB	10 ganchos clip grande	€ 15,00

Carris

ALU450 | € 16,00

Painel com 4 carris de 450mm, inclui 10 clips de 1/4", 3/8" e 1/2".

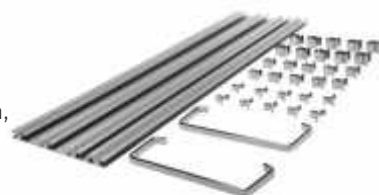

Carris individuais.

nº TengTools		Preço
ALU430	carril de 430mm	€ 3,70
ALU450	carril de 450mm	€ 16,00
ALU1000-1	carril de 1000mm	€ 7,40
ALU1000-4	jogo 4 carris de 1000mm	€ 17,00

Clips para chaves de caixa.

nº TengTools		Preço
ALU14	10 clips para chaves 1/4"	€ 2,10
ALU38	10 clips para chaves 3/8"	€ 2,10
ALU12	10 clips para chaves 1/2"	€ 2,10
ALU34	10 clips para chaves 3/4"	€ 4,30



Fechaduras

**TC-90CLOCK | € 22,00**

Fechadura de código, para TC803N, TC803NBK, TCW803N, TCW804N, TCW806N, TCW806N1, TCW807N, TCW810N, TCW810NBK, TCW207N, TCW806LN e TCW809N.

TC-180CLOCK | € 22,00

Fechadura de código, para TC803N, TC803NBK, TCW803N, TCW804N, TCW806N, TCW806N1, TCW807N, TCW810N, TCW810NBK, TCW207N, TCW806LN e TCW809N.

TC-DRK | € 13,00

Jogo de fechadura + chaves, para TC803SV e TCW707EV

TC-PRK | € 15,00

Jogo de fechadura+ chaves, para TCW806SV e TCW-CAB.

TCW-PRK | € 13,00

Jogo de fechadura+ chaves, para carros TCW.

TC-LOCK3 | € 29,00

Jogo de 3 fechaduras + chaves, para kits Mega Master e TC816SV. Ideal para quem quer usar uma chave para qualquer armário.

TC-LOCK5 | € 40,00

Jogo de 5 fechaduras + chaves. Ideal para quem quer usar uma chave para qualquer armário.

Rodas

TCW-SW | € 37,00

Jogo de duas rodas pivô de 4"(100mm).

**TC-NBC | € 135,00**

Jogo de quatro rodas de 5"(125mm), duas fixas e duas pivô com travão.

**TCW-IQSC | € 153,00**

Jogo de quatro rodas de 6"(150mm), duas fixas e duas pivô com travão.



Coberturas

TC-COVER | € 16,00

Lona para baús de topo com 3, 4 e 6 gavetas.

**TCW-C02 | € 30,00**

Lona para carros de 7, 8 ou 10 gavetas.

**TC-COVER1 | € 43,00**

Conjunto de lonas para kits de ferramenta, compostos por baús de topo, intermédios e carros de 7, 8 ou 10 gavetas.



TT-ALU | € 14,30

Tabuleiro TT

Inclui: 2 corrediças de 260mm, 10 clips 1/4" (ALU14), 10 clips 3/8" (ALU38) e 10 clips 1/2" (ALU12).



TT Sets



TT-00 | € 9,20

Tabuleiro TT

Inclui: 2 jogos de clips para chave de bocas, luneta e chaves de parafuso.



TT Sets



TT-01 | € 9,20

Tabuleiro TT

Inclui: tabuleiro PS com 7 compartimentos.



TT Sets



TT-02 | € 9,20

Tabuleiro TT

Inclui: tabuleiro PS com 2 compartimentos.



TT Sets



TT-03 | € 9,20

Tabuleiro TT

Inclui: tabuleiro PS com 4 compartimentos.



TT Sets



TT-04 | € 9,20

Tabuleiro TT

Inclui: tabuleiro PS com 6 compartimentos.



TT Sets



TT-J04 | € 9,00

Tabuleiro TT

Inclui: tabuleiro PS com 4 compartimentos pª jogos TJ



TT Sets



TTZ-01 | € 8,00

Tabuleiro TTZ

Inclui: tabuleiro PS com 6 compartimentos.



TTZ Sets



TTD-00 | € 14,50

Tabuleiro TTD

Inclui: tabuleiro PS com 4 compartimentos.



TTD Sets



TTD-01 | € 14,50

Tabuleiro TTD

Inclui: tabuleiro PS com 8 compartimentos.



TTD Sets



TTD02 | € 14,50

Tabuleiro TTD

Inclui: tabuleiro PS com 16 compartimentos.



TTD Sets



TTX00 | € 9,10

Tabuleiro TTX

Para uso geral.



TTX Sets

**TTX01 | € 11,00**

Tabuleiro TTX

Inclui: tabuleiro PS com 6 compartimentos.



TTX Sets

**TTX02 | € 11,00**

Tabuleiro TTX

Inclui: tabuleiro PS com 4 compartimentos.



TTX Sets

**TTX03 | € 11,00**

Tabuleiro TTX

Inclui: tabuleiro PS com 8 compartimentos.



TTX Sets



Acessórios 1/4"	roquete 1400-72N , junta universal, extensões de 2" e 4", adaptador F3/8":M1/4", punho.
-----------------	---

Chaves 1/4"	6 pontos 4,5, 5,5, 6, 7, 8, 9, 10, 11, 12, 13mm
-------------	---

Chaves longas 1/4"	6 pontos 6, 7, 8, 10, 12, 13mm
--------------------	--------------------------------

Bits 1/4" hex.	TX10, TX15, TX20, Umbrako 5, 6mm, PH1, PH2, PZ1, PZ2, fenda 4, 5.5mm
----------------	--

Contem: 1400-72N, M140015, M140020, M140021, M140030, M140060, M140504, M140505, M140505, M140506, M140507, M140508, M140509, M140510, M140511, M140512, M140513, M140606, M140607, M140608, M140610, M140612, M140613, M380035, Bits.

TT-1435 | € 68,00

Tabuleiro TT 35 peças 1/4".

TT Sets
1/4"

Acessórios 1/4"	roquete PM14 , extensão de 3".
-----------------	--------------------------------

Chaves 1/4"	6 pontos 5, 5.5, 6, 7, 8, 9, 10, 11, 12, 13mm
-------------	---

Bits 1/4" hex.	25mm-TX10, TX15, TX20, tx25, tx30 tx40, Tpx20, Tpx25, Tpx30, tx25, tx30 tx40, umbrako 2, 3, 4, 5, 6, 8mm, PH1, PH2, ph3, PZ1, PZ2, PZ3, fenda 3,5, 5.5, 8mm. rob 1, 2, 3. 89mm- fenda 3, 4mm, ph1, ph2, pz1, pz2, tx10, tx20, tx25
----------------	--

Contem: PM14, M1400235, M140505, M1405055, M140506, M140507, M140508, M140509, M140510, M140511, M140512, M140513, Bits.

TT-1448 | € 65,00

Tabuleiro TT 48 peças 1/4".

TT Sets
1/4"

TT-MDQ49 | € 66,00

Tabuleiro TT 49 peças 1/4"



TT Sets
1/4"



Acessórios 1/4"		chave de bits encaixe rápido, adaptador tipo roquete 1/4", adaptador M1/4":HEX 1/4"
Chaves caixa 1/4"	6 pontos	4, 5, 5.5, 6, 7, 8, 9, 10, 11, 12, 13mm
Bits 1/4" hex.	25mm	fenda 3.5, 5.5, 8mm, PH1, PH2, PH3, PZ1, PZ2, PZ3, TX10, TX15, TX20, TX25, TX30, TX40, umbrako 2, 3, 4, 5, 6, 8, ROB1, ROB2, ROB3, TPX20, TPX25, TPX30
Bits 1/4" hex.	89mm	fenda 4mm, PH1, PH2, umbrako 4mm, PZ2, TX10, TX20, TX25

Contem: MDQ147, RHA14, M140037, M140504, M140505, M1405055, M140506, M140507, M140508, M140509, M140510, M140511, M140512, M140513. Bits..

TT-THQ62 | € 55,00

Tabuleiro TT 62 peças 1/4"



TT Sets
1/4"



Acessórios 1/4"		chave de bits T com encaixe rápido, adaptador M1/4":HEX 1/4"
Chaves caixa 1/4"	6 pontos	5, 5.5, 6, 7, 8, 9, 10, 11, 12, 13mm
Chaves TX-E 1/4"		E4, E5, E6, E7, E8
Bits 1/4" hex.		fenda 3.5, 5.5, 8mm, PH1, PH2, PH3, PZ1, PZ2, PZ3, TX6, TX7, TX8, TX9, TX10, TX15, TX20(x3), TX25(x3), TX27, TX30, TX40, umbrako 2, 3, 4, 5, 6, 8mm, ROB1, ROB2, ROB3, TPX10, TPX15, TPX20(x2), TPX25(x2), TPX27, TPX30, TPX40, GR2(x3)

Contem: MDTHQ, M140037, M140505, M1405055, M140506, M140507, M140508, M140509, M140510, M140511, M140512, M140513, M140704, M14705, M140706, M140707, M140708. Bits,

TT-MDQ76 | € 54,00

Tabuleiro TT 76 peças 1/4"



TT Sets
1/4"



Acessórios 1/4"		chave de bits encaixe rápido, adaptador M1/4":HEX 1/4"
Chaves caixa 1/4"	6 pontos	4, 5, 5.5, 6, 7, 8, 9, 10, 11, 12, 13mm
Bits 1/4" hex.	25mm	fenda 3.5, 4, 4.5, 5.5(x2), 6.5, 8mm, PH1(x3), PH2(x6), PH3, PZ1(x3), PZ2(x6), PZ3, TX6, TX7, TX8, TX9, TX10, TX15, TX20(x3), TX25(x3), TX27, TX30, TX40, umbrako 2, 3, 4, 5, 6, 8mm, ROB1, ROB2, ROB3, TPX10, TPX15, TPX20(x2), TPX25(x2), TPX27, TPX30, TPX40, GR2(x3)

Contem: MDQ217, M140037, M140504, M140505, M1405055, M140506, M140507, M140508, M140509, M140510, M140511, M140512, M140513. Bits.

TT-MDR84 | € 62,00

Tabuleiro TT 84 peças 1/4"



TT Sets
1/4"



Acessórios 1/4"		chave de bits reversível com encaixe rápido, adaptador M1/4":HEX 1/4", extensão flexível 150mm
Chaves caixa 1/4"	6 pontos	4, 5, 5.5, 6, 7, 8, 9, 10, 11, 12, 13mm
Bits 1/4" hex.	25mm	fenda 3.5, 4, 4.5, 5.5(x2), 6.5, 8mm, PH1(x3), PH2(x6), PH3, PZ1(x3), PZ2(x6), PZ3, TX6, TX7, TX8, TX9, TX10, TX15, TX20(x3), TX25(x3), TX27, TX30, TX40, umbrako 2, 3, 4, 5, 6, 8mm, ROB1, ROB2, ROB3, TPX10, TPX15, TPX20(x2), TPX25(x2), TPX27, TPX30, TPX40, GR2(x3)

Contem: MDRQ908, M140037, TTMD74-2, M140504, M140505, M1405055, M140506, M140507, M140508, M140509, M140510, M140511, M140512, M140513. Bits.

TT-MDRT64 | € 59,00

Tabuleiro TT 64 peças 1/4"



TT Sets
1/4"



Acessórios	1/4"	chave de bits com roquete, inclui 7 bits, fendas 5 e 7mm, PH1, PH2, PZ1, PZ2, adaptador M1/4":HEX1/4".
Chaves de caixa	1/4"	4, 5, 5.5, 6, 7, 8, 9, 10, 11, 12, 13mm
Bits 25mm	1/4" hex	fendas 0.6x3.5, 0.6x4.5, 0.8x4.0, 0.8x5, 0.8x5.5, 1.0x5.5, 1.2x6.5, 1.2x7.0, 1.6x8.0mm, PH1 (x 4), PH2 (x 4), PH3 (x 2), PZ1, PZ2 x 3, PZ3 (x 2), TX6, TX7, TX8, TX9, TX10, TX15, TX20 (x 3), TX25 (x 3), TX27, TX30, TX40, hexagonais 2, 3, 4 (x 3), 5, 6, 8mm, ROB1, 2, 3.

Contem: MDR915, ACCSDA1414, M140504, M140505, M1405055, M140506, M140507, M140508, M140509, M140510, M140511, M140512, M140513, Bits.



Acessórios 3/8"	roquete 3800-72N, junta universal, extensão oscilante 3", punho 10", adaptador de barra F1/2": M3/8".
Chaves 3/8"	6 pontos 8, 9, 10, 11, 12, 13, 14, 15, 16, 17, 18, 19, 22mm

Contem: 3800-72N, M120036, M380020W, M380030, M380060, M380508, M380509, M380510, M380511, M380512, M380513, M380514, M380515, M380516, M380517, M380518, M380519, M380522, PT3810R.

Chaves Longas 3/8" 6 pontos 7, 8, 9, 10, 11, 12, 13, 14, 15, 16, 17, 18, 19, 20, 21, 22mm

Contem: M380607, M380608, M380609, M380610, M380611, M380612, M380613, M380614, M380615, M380616, M380617, M380618, M380619, M380620, M380621, M380622.

Chaves 1/4" 6 pontos 3/16", 7/32", 1/4", 9/32", 5/16", 11/32", 3/8", 7/16", 1/2"

Chaves longas 1/4" 6 pontos 3/16", 7/32", 1/4", 9/32", 5/16", 11/32", 3/8", 7/16", 1/2"

Chaves 3/8" 6 pontos 3/8", 7/16", 1/2", 9/16", 5/8", 11/16", 3/4"

Chaves longas 3/8" 6 pontos 3/8", 7/16", 1/2", 9/16", 5/8", 11/16", 3/4"

Contem: M140106, M140107, M140108, M140109, M140110, M140111, M140112, M140114, M140116, M140206, M140207, M140208, M140209, M140210, M140211, M140212, M140214, M140216, M380112, M380114, M380116, M380118, M380120, M380122, M380124, M380212, M380214, M380216, M380218, M380220, M380222, M380224C.

Acessórios	3/8"	extensão 3", adaptador F3/8":M1/4"
Bits	3/8"	TX10, TX15, TX20, TX25, TX27, TX30, TX40, TX45, TX50
	3/8"	TRX10, TRX15, TRX20, TRX25, TRX27, TRX30, TRX40, TRX45, TRX50
Chaves TX-E	1/4"	E4, E5, E6, E7, E8
	3/8"	E10, E12, E14, E16, E18

Contem: M140704, M140705, M140706, M140707, M140708, M380020, M380035, M380710, M380712, M380714, M380716, M380718, M381210, M381210T, M381215, M381215T, M381220, M38122T, M381225, M381225T, M381227, M381227T, M381230, M381230T, M381240, M381240T, M381245, M381245T, M381250, M381250T.

Acessórios	3/8"	adaptador F1/4":M3/8", adaptador F3/8":M1/4"
Bits	1/4"	PH0, PH1, PH2, PH3, PZ1, PZ2, PZ3, fenda 4, 4.5, 7mm, TX10, TX15, TX20, TX25, TX27, TX30, TX40
	3/8"	3, 4, 5, 5.5, 6, 7, 8, 10, 12mm
Bit Hex.	3/8"	1/8", 5/32", 3/16", 7/32", 1/4", 5/16", 3/8"

Contem: M140036, M141210T, M141215T, M141220T, M141225T, M141227T, M141230T, M141240T, M141300, M141301, M141302, M141303, M141404, M1414055, M141407, M141601, M141602, M141603, M380035, M381104, M381105, M381106, M381107, M381108, M381110, M381112, M381503, M381504, M381505, M3805055, M381506, M381507, M381508, M381510, M381512.

TT-3819 | € 79,00

Tabuleiro TT 19 peças Autocler 3/8".

TT Sets
3/8"**TT-3816 | € 45,00**

Tabuleiro TT com 16 chaves de caixa longas 3/8".

TT Sets
3/8"**TT-AF32 | € 45,00**

Tabuleiro TT com 32 chaves de caixa 1/4" e 3/8"

TT Sets
1/4"
3/8"**TT-TX30 | € 75,00**

Tabuleiro TT com 30 peças, bits de caixa 1/4" e 3/8".

TT Sets
1/4"
3/8"**TT-BS35 | € 51,00**

Tabuleiro TT com 35 peças, bits de caixa 1/4" e 3/8".

TT Sets
1/4"
3/8"

TTX-TB05 | € 89,00

Tabuleiro TTX 5 peças 3/8".



TTX Sets
3/8"



Acessórios conjunto 2 peças barra T

Chaves de velas 14, 16, 21mm

Contem: MTBUSB14, MTBUSB16, MTBUSB21, THD, THD01.

TTX-TB09 | € 119,00

Tabuleiro TT 9 peças 3/8".



TTX Sets
3/8"



Acessórios conjunto 2 peças barra T

Chaves de velas 8, 10, 12, 13, 14, 17, 19mm

Contem: TBSKT08, TBSKT10, TBSKT12, TBSKT13, TBSKT17, TBSKT19, THD, THD01.

TT-1205 | € 72,00

Tabuleiro TT 5 peças 1/2".



TT Sets
1/2"



Acessórios

roquete 1/2", junta universal, extensões de 5" e 10", adaptador com furação para barra T F3/8":M1/2"

Contem: 1200-72N, M120021, M120022, M120030, M380036.

TT-1211 | € 67,00

Tabuleiro TT 11 peças 1/2".



TT Sets
1/2"



Acessórios 1/2"

cabo articulado com punho bi-materia

Ch. cx. longas 1/2" 12 pontos 10, 11, 12, 13, 14, 15, 16, 17, 18, 19mm

Contem: M120010, M120610, M120611, M120612, M120613, M120614, M120615, M120616, M120617, M120618, M120619.

TT-1218 e TT-1218-6 | € 89,00

Tabuleiro TT 18 peças 1/2".(12 pontos ou 6 pontos)



TT Sets
1/2"



Acessórios

roquete 1/2", junta universal, extensões de 2 1/2" e 6", adaptador com furação para barra T F3/8":M1/2"

Chaves caixa 1/2" 10, 11, 12, 13, 14, 15, 16, 17, 18, 19, 22, 24mm

TT1218 Contem: 1200-72N, M120020, M120023, M120510, M120511, M120512, M120513, M120514, M120515, M120516, M120517, M120518, M120519, M120522, M120524, M120030, M380036.

TT1218-6 Contem: 1200-72N, M120020, M120023, M1205106, M1205116, M1205126, M1205136, M1205146, M1205156, M1205166, M1205176, M1205186, M1205196, M1205226, M1205246, M1200306, M380036.



Chaves caixa 1/2"	10, 11, 12, 13, 14, 15, 16, 17, 18, 19, 20, 21, 22, 24, 27, 30, 32mm
-------------------	--

TT1217 Contem: M120510, M120511, M120512, M120513, M120514, M120515, M120516, M120517, M120518, M120519, M120520, M120521, M120522, M120524, M120527, M120530, M120532.

TT1217-6 Contem: M1205106, M1205116, M1205126, M1205136, M1205146, M1205156, M1205166, M1205176, M1205186, M1205196, M1205206, M1205216, M1205226, M1205246, M1205276, M1205306, M1205326.

Chaves caixa 1/2"	12 pontos	3/8", 7/16", 1/2", 9/16", 5/8", 11/16", 3/4", 13/16", 7/8", 15/16", 1", 1 1/16", 1 1/8", 1 3/16", 1 1/4".
-------------------	-----------	---

Contem: M120112, M120114, M120116, M120118, M120120, M120122, M120124, M120126, M120128, M120130, M120132, M120134, M120136, M120138, M120140.

Ponta hexagonal	55mm	5, 6, 7, 8, 9, 10, 12, 14, 17mm
-----------------	------	---------------------------------

Ponta hexagonal	100mm	5, 6, 10, 12, 14, 17mm
-----------------	-------	------------------------

Ponta hexagonal	115mm	8mm
-----------------	-------	-----

Contem: M121505, M121506, M121507, M121508, M121509, M121510, M121511, M121512, M121514, M121517, M122505, M122506, M122510, M122512, M122514, M122517, M122508A.

Ponta TX	55mm	TX20, TX25, TX27, TX30, TX40, TX45, TX50, TX55, TX60
----------	------	--

Ponta TX	110mm	TX20, TX25, TX27, TX30, TX40, TX45, TX50, TX55, TX60
----------	-------	--

Contem: M121220T, M121225T, M121227T, M121230T, M121240T, M121245T, M121250T, M121255T, M121260T, M122220T, M122225T, M122227T, M122230T, M122240T, M122245T, M122250T, M122255T, M122260T.

Ponta Ribe	100mm	No. 4, 5, 6, 8, 10, 11, 12, 13
------------	-------	--------------------------------

Ponta XZN	100mm	No. 5, 6, 8, 10, 12, 14, 16
-----------	-------	-----------------------------

Contem: M122704, M122705, M122706, M122708, M122710, M122711, M122712, M122713, M122805, M122806, M122808, M122810, M122812, M122814, M122816.

TT-1217 e TT-1217-6 | € 50,00

Tabuleiro TT 18 peças 1/2". (12 pontos ou 6 pontos)



TT Sets
1/2"

TT-1215AF | € 50,00

Tabuleiro TT 15 peças 1/2". (12 pontos)



TT Sets
1/2"

TT-HEX16 | € 70,00

Tabuleiro TT 16 peças 1/2" com ponta hexagonal.



TT Sets
1/2"

TT-TX18 | € 73,00

Tabuleiro TT 18 peças 1/2" com ponta TX.



TT Sets
1/2"

TT-RS15 | € 79,00

Tabuleiro TT 15 peças 1/2" com pontas Ribe e XZN.



TT Sets
1/2"



TT-TXH15 | € 74,00

Tabuleiro TT 15 peças 1/2" hexagonal e TX.



TT Sets
1/2"



Ponta hexagonal	100mm	5, 6, 7, 8, 10, 12mm
Ponta TX	100mm	TX20, TX25, TX27, TX30, TX40, TX45, TX50, TX55, TX60

Contem: M122220T, M122225T, M122227T, M122230T, M122240T, M122245T, M122250T, M122255T, M122260T, M122505, M122506, M122507, M122508, M122510, M122512.

TT-HEX23 | € 52,00

Tabuleiro TT 23 peças, bits e acessórios.



TT Sets
1/2"



Acessórios	adaptador 1/2" para bits hexagonais 10mm, adaptador 1/2" para bits hexagonais 12mm, mini chave de parafusos hexagonal	
Bits hex. 40mm	hex. 10mm	5, 6, 7, 8, 9, 10mm
	hex. 12mm	12, 14, 17, 19mm
Bits hex. 75mm	hex. 10mm	5, 6, 7, 8, 9, 10mm
	hex. 12mm	12, 14, 17, 19mm

Contem: 210705, 210706, 210707, 210708, 210709, 210710, 210712, 210714, 210717, 210719, 210805, 210806, 210807, 210808, 210809, 210810, 210812, 210814, 210817, 210819, M120061, M120062, MDM711.

TT-TX23 | € 47,00

Tabuleiro TT 23 peças, bits TX e acessórios.



TT Sets
1/2"



Acessórios	adaptador 1/2" para bits hexagonais 10mm, adaptador 1/2" para bits hexagonais 12mm, mini chave de parafusos hexagonal	
Bits hex. 40mm	hex. 10mm	TX20, TX25, TX27, TX30, TX40, TX45, TX50, TX55
	hex. 12mm	TX60, TX70
Bits hex. 75mm	hex. 10mm	TX20, TX25, TX27, TX30, TX40, TX45, TX50, TX55
	hex. 12mm	TX60, TX70

Contem: 220720, 220725, 220727, 220730, 220740, 220745, 220750, 220755, 220760, 220770, 220820, 220825, 220827, 220830, 220840, 220845, 220850, 220855, 220860, 220870, M120061, M120062, MDM711.

TT-ADP17 | € 73,50

Tabuleiro TT 17 peças, adaptadores.



TT Sets
1/4"
3/8"
1/2"
3/4"



Aumentos	3/4"F:1"M, 1/2"F:3/4"M, 3/8"F:1/2"M, 1/4"F:3/8"M
Reduções	3/4"F:1/2"M, 1/2"F:3/8M, 3/8"F:1/4"M a
Adaptador Bits	1/4" e 3/8" para bits hexagonais 1/4"
Adapt. Bits hexagonal	1/4" e 3/8" macho
Adapt. Bits hex. 50mm	1/4", 3/8" e 1/2" macho
Encabadouro Magnético	50 e 70mm
Encabadouro rápido	50mm

Contem: M380036, M120037, M140036, M340085, M340086, M120036, M380035, M140037, M380037, M140060, M380060, ACCSDA1414, ACCSDA1438, ACCSDA1412, ACC50MBH01, ACC70MBH01, ACC50CBH01.

TTX-EXT13 | € 94,00

Tabuleiro TTX 13 peças, extensões e acessórios.

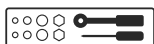

TTX Sets
1/4"
3/8"
1/2"



Acessórios	1/4"	extensões de 6" e 12", junta universal
	3/8"	extensão flexível 3", extensão 20", junta universal, adaptador com furação para barra T F3/8":M1/4"
	1/2"	extensão flexível 3", extensão 20", junta universal
Acessórios	chaves de parafuso hexagonal de 2 e 2.5mm, punho em T	

Contem: M140022, M140024, M140030, M380020W, M380024, M380030, M380035, M120020W, M120024, M120030, THD, MDM711, MDM712



Acessórios 3/4" roquete reversível 72 dentes com botão de desbloqueio, extensão de 400mm

Contem: M340072E, M340022

TTX-3402E | € 206,00

Tabuleiro TTX 2 peças 3/4".



TTX Sets
3/4"



Acessórios 3/4" roquete reversível 72 dentes com botão de desbloqueio, extensão de 400mm e 600mm, barra T deslizante

Contem: M340021, M340022, M3400-72, M340050

TTX-3404 | € 199,00

Tabuleiro TTX 4 peças 3/4".

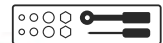

TTX Sets
3/4"



Acessórios 3/4" roquete reversível 72 dentes com botão de desbloqueio, extensão de 400mm e 600mm, barra T deslizante

Contem: M340021S, M340022S, M340030, M340050S

TTX-3404S | € 227,00

Tabuleiro TTX 4 peças 3/4".(sistema de segurança)

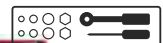

TTX Sets
3/4"



Chaves caixa 3/4" 6 pontos 19, 21, 22, 24, 27, 30, 32, 33, 34, 36, 38, 41, 46, 50mm

Contem: M3405196, M3405216, M3405226, M3405246, M3405276, M3405306, M3405326, M3405336, M3405346, M3405366, M3405386, M3405416, M3405466, M3405506.

TTX-3414 | € 138,00

Tabuleiro TTX14 peças 3/4".

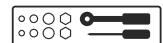

TTX Sets
3/4"



Chaves caixa 3/4" 12 pontos 7/8", 15/16", 1", 1 1/16", 1 1/8", 1 1/16", 1 1/4", 1 1/8", 1 3/8", 1 7/16", 1 1/2", 1 5/8", 1 3/4", 1 5/8"

Contem: M340128, M340130, M340132, M340134, M340136, M340138, M340140, M340142, M340144, M340146, M340148, M340152, M340156, M340160.

TTX-34AF | € 141,00

Tabuleiro TT 14 peças, chaves de caixa 3/4".



TTX Sets
3/4"



TT-6208 | € 40,00

Tabuleiro TT, 8 chaves de bocas.



TT Sets



Chaves boca 6x7, 8x9, 10x11, 12x13, 14x15, 16x17, 18x19, 20x22mm

Contem: 620607, 620809, 621011, 621213, 621415, 621617, 621819, 622022.

TTX-6607 | € 82,00

Tabuleiro TTX, 7 chaves bocas polegadas



TTX Sets



Chaves bocas 1/4-5/16, 3/8-7/16, 1/2-9/16, 5/8-3/4, 13/16-7/8, 15/16-1, 1 1/8-1 1/4

Contem: 663032, 663436, 663840, 664244, 664648, 665052, 665456

TT-1236 | € 57,00

Tabuleiro TT, 12 chaves boca/luneta.



TT Sets



Chaves boca/luneta 8, 9, 10, 11, 12, 13, 14, 15, 16, 17, 18, 19mm

Contem: 600508, 600509, 600510, 600511, 600512, 600513, 600514, 600515, 600516, 600517, 600518, 600519.

TT-3592 | € 48,00

Tabuleiro TT, 8 chaves boca/luneta.



TT Sets



Chaves boca/luneta 5/16", 3/8", 7/16", 1/2", 9/16", 5/8", 11/16", 3/4"

Contem: 600110, 600112, 600114, 600116, 600118, 600120, 600122, 600124.

TT-8012 | € 84,00

Tabuleiro TT, 12 chaves boca/luneta anti-deslizantes



TT Sets



Chaves boca/luneta 8, 9, 10, 11, 12, 13, 14, 15, 16, 17, 18, 19mm

Contem: 800608, 800609, 800610, 800611, 800612, 800613, 800614, 800615, 800616, 800617, 800618, 800619.



Chaves boca/luneta 8, 10, 11, 12, 13, 14, 17mm

Contem: 600508R, 600510R, 600511R, 600512R, 600513R, 600514R, 600517R, 600519R.



TT-6508R | € 179,00

Tabuleiro TT, 8 chaves boca/luneta com roquete reversível.



TT Sets

Chaves boca/luneta 5/16", 3/8", 7/16", 1/2", 9/16", 5/8", 11/16", 3/4"

Contem: 600110R, 600112R, 600114R, 600116R, 600118R, 600120R, 600122R, 600124R.



TT-6508RAF | € 193,00

Tabuleiro TT, 8 chaves boca/luneta com roquete reversível.



TT Sets

Chaves boca/luneta 8, 10, 11, 12, 13, 14, 15, 16, 17, 18, 19mm

Contem: 600508R, 600510R, 600511R, 600512R, 600513R, 600514R, 600515R, 600516R, 600517R, 600518R, 600519R.



TT-6511R | € 224,00

Tabuleiro TT, 11 chaves boca/luneta com roquete reversível.



TT Sets

Chaves boca/luneta 8, 10, 11, 12, 13, 14, 17mm

Contem: 600508RF, 600510RF, 600511RF, 600512RF, 600513RF, 600514RF, 600517RF, 600519RF.



TT-6508RF | € 165,00

Tabuleiro TT, 8 chaves boca/luneta flexíveis roquete.



TT Sets

Chaves boca/luneta 8, 10, 11, 12, 13, 14, 17, 19mm

Contem: 600508RS, 600510RS, 600511RS, 600512RS, 600513RS, 600514RS, 600517RS, 600519RS.



TT-6508RS | € 148,00

Tabuleiro TT, 8 chaves boca/luneta com roquete.



TT Sets



TT-6511RS | € 202,00

Tabuleiro TT, 11 chaves boca/luneta com roquete.



TT Sets



Chaves boca/luneta 8, 10, 11, 12, 13, 14, 15, 16, 17, 18, 19mm

Contem: 600508RS, 600510RS, 600511RS, 600512RS, 600513RS, 600514RS, 600515RS, 600516RS, 600517RS, 600518RS, 600519RS.

TTX-2032 | € 93,00

Tabuleiro TTX, 7 chaves boca/luneta.



TTX Sets



Chaves boca/luneta 20, 21, 22, 24, 27, 30, 32mm

Contem: 600520, 600521, 600522, 600524, 600527, 600530, 600532.

TTX-2436 | € 135,00

Tabuleiro TTX, 6 chaves boca/luneta.



TTX Sets



Chaves boca/luneta 24, 27, 30, 32, 34, 36mm

Contem: 600524, 600527, 600530, 600532, 600534, 600536

TTX-2640 | € 94,00

Tabuleiro TTX, 7 chaves boca/luneta.



TTX Sets



Chaves boca/luneta 13/16", 7/8", 15/16", 1", 1 1/16", 1 1/8", 1 1/4"

Contem: 600126, 600128, 600130, 600132, 600134, 600136, 600140.

TTX-LMP12 | € 87,00

Tabuleiro TTX, 12 chaves boca/luneta Longas



TTX Sets



Chaves boca/luneta 8, 9, 10, 11, 12, 13, 14, 15, 16, 17, 18, 19mm

Contem: 605908, 605909, 605910, 605911, 605912, 605913, 605914, 605915, 605916, 605917, 605918, 605919.



Ch. boca/luneta 10, 11, 12, 13, 14, 15, 16, 17, 18, 19, mm

Contem: 6005M10, 6005M11, 6005M12, 6005M13, 6005M14, 6005M15, 6005M16, 6005M17, 6005M18, 6005M19.



TT-6010M | € 65,00

Tabuleiro TT, 10 mini chaves boca/luneta.



TT Sets

Ch. boca/luneta 10, 11, 12, 13, 14, 15, 16, 17, 18, 19, mm

Contem: 6005M10RS, 6005M11RS, 6005M12RS, 6005M13RS, 6005M14RS, 6005M15RS, 6005M16RS, 6005M17RS, 6005M18RS, 6005M19RS..



TT-6010MRS | € 131,00

Tabuleiro TT, 10 mini chaves boca/luneta roquete



TT Sets

Chaves luneta 6x7, 8x9, 10x11, 12x13, 14x15, 16x17, 18x19, 20x22, 21x23, 24x27, 30x32mm

Contem: 630607, 630809, 631011, 631213, 631415, 631617, 631819, 632022, 632123, 632427, 633032.



TTX-6311 | € 119,00

Tabuleiro TTX, 11 chaves luneta.

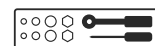

TTX Sets

Chaves luneta 1/4-5/16, 3/8-7/16, 1/2-7/16, 13/16-7/8, 15/16-1 1/16, 1-1 1/8, 1 -1/8-1 1/4.

Contem: 673032, 673436, 673840, 674244, 674648, 675052, 675456



TTX-6707 | € 112,00

Tabuleiro TTX, 7 chaves luneta polegadas



TTX Sets

Chaves luneta 8x10, 11x13, 12x14, 16x18, 17x19, 22x24mm

Contem: 630810FL, 631113FL, 631214FL, 631618FL, 631719FL, 632224FL.



TTX-FLS06 | € 185,00

Tabuleiro TTX, 6 chaves boca/luneta planas extra longas.



TTX Sets



TT-RORS | € 66,00

Tabuleiro TT, 6 chaves luneta com roquete.



TT Sets



Chaves luneta 6x8, 7x9, 10x13, 12x14, 17x19, 21x22mm

Contem: 680608, 680709, 681013, 681214, 681719, 682122.

TT-HP08 | € 112,00

Tabuleiro TT 8 peças, chaves de unha



TT Sets



Unha 3/4" a 2", 1/4" a 3", 2" a 4 3/4"mm

Unha com pino 4, 5, 6mm

Pinos 6, 8mm

Contem: HP101, HP102, HP103.

TT-ADJ04 | € 96,00

Tabuleiro TT 4 peças, chaves crescentes.



TT Sets



Chaves Crescentes 6"(23,9mm), 8"(28,6mm), 10"(32,8mm) e WT 8"(38,6mm)

Contem: 4002IQ, 4003IQ, 4004IQ, 4003WT.

TT-6506 | € 97,00

Tabuleiro TT, 6 chaves flexíveis.



TT Sets



Chaves flexível 8x9, 10x11, 12x13, 14x15, 16x17, 18x19mm

Contem: 650809, 651011, 651213, 651415, 651617, 651819.

TTX-QRS07 | € 338,00

Tabuleiro TTX, 8 chaves anelares.



TTX Sets



Chaves anelares 13, 17, 19, 22, 24, 27mm

Contem: 600813, 600817, 600819, 600822, 600824, 600827, 600832.



Chave dinamométrica	3/8"	angular gauge torque wrench (20-110Nm, 15-75 ft/lb)
Acessórios	3/8"	3" and 5" extensions, adaptor for 10mm hex bits
Bits 10mm	hex	TX8, TX10, TX15, TX20, TX25, TX27, TX30, TX40
Chave de boca(cabeça)	3/8"	10, 11, 12, 13, 14, 15, 16, 17, 18, 19mm

Contem: 3892AG-E3, M386510, M386511, M386512, M386513, M386514, M386515, M386516, M386517, M386518, M386519, 220708, 220710, 220715, 220720, 220725, 220727, 220730, 220740, M380020, M380023, M380061.

Chave dinamométrica	quadra 1/2"	angular (40-210Nm, 30-150ft/lb)
---------------------	-------------	---------------------------------

Contem: 1292AG-EP.

Chave dinamométrica	quadra 1/2"	angular (40-200Nm, 30-155ft/lb)
---------------------	-------------	---------------------------------

Contem: 1292P200

Chaves dinamométrica 1/2"	90, 110, 120, 140Nm
---------------------------	---------------------

Contem: 1292AG-090, 1292AG-110, 1292AG-120, 1292AG-140.

Chave dinamométrica	quadra 1/2"	angular (40-210Nm, 30-150ft/lb)
---------------------	-------------	---------------------------------

Multiplicador F1/2":M3/4", rácio 3:1 e torque máximo 1500Nm

Contem: 1292AG-EP, MP1400.

TTX-3892 | € 145,00

Tabuleiro TTX 28 peças, chave dinamométrica

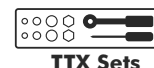

TTX Sets



TTX-1292 | € 72,00

Tabuleiro TTX , chave dinamométrica 1/2".

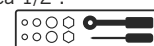

TTX Sets



TTX-P1292 | € 127,00

Tabuleiro TTX , chave dinamométrica 1/2".

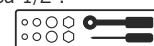

TTX Sets



TT-PSTQ04 | € 220,00

Tabuleiro TTPS, 4 chaves dinamométricas 1/2".

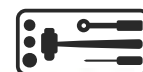

TTPS Sets



TTX-MP12 | € 448,00

Tabuleiro TTX 2 peças, chave dinamométrica e multiplicador.

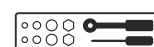

TTX Sets



TT-SD38 | € 90,00

Tabuleiro TT 38 peças, chave dinamométrica



TT Sets



Acessórios	adaptador 1/4" x 1/4"
Chaves Dinamométrica	1 a 5Nm
Contem: 1492TSD, M140039, bits	

TT-SD39 | € 101,00

Tabuleiro TT 39 peças, chave dinamométrica



TT Sets



Bits 25mm	1/4" hex	PH0, PH1, PH2, PH3 - PZ0, PZ1, PZ2, PZ3 ROB1, ROB2, ROB3 - GR PH2x2 pc - hex 2, 3, 4, 5, 6mm TX8, TX9, TX10, TX15, TX20, TX25, TX27, TX30, TX40 TPX10, TPX15, TPX20, TPX25, TPX30 fenda 3.0x0.5mm, 4.5x0.6mm 5.5x0.8mm, 6.5x1.2mm
Acessórios	1/4"	chave bits dinamométrica 1-5Nm, extensão 4" - + Adapt.
Contem: 1492SD, M140021-C, BITS.		

TTD-AWM13M | € 270,00

Tabuleiro TTD 13 peças, aparafusadora impacto



TTD Sets
1/2"



Acessórios	aparafusadora de impacto AR, torque máximo 770Nm
Chaves cx. Impacto 1/2"	10, 12, 13, 14, 15, 16, 17, 18, 19, 21, 22, 24mm
Contem: ARWM12M, 920510, 920512, 920523, 920514, 920515, 920516, 920517, 920518, 920519, 920521, 920522, 920524.	

TT-9207 | € 73,00

Tabuleiro TT 7 peças, ch impacto 1/2".



TT Sets
1/2"



Acessórios	1/2"	extensões de 3", 5" e 10", junta universal, adaptadores F3/8":M1/2", F1/2":M3/4", F1/2":M3/8"
Contem: 980036, 920037, 920036, 920030, 920020, 920021, 920023.		

TT-9207A | € 73,00

Tabuleiro TT 7 peças, ch impacto 1/2" (sistema segurança)



TT Sets
1/2"



Acessórios	1/2"	extensões de 3", 5" e 10", junta universal, adaptadores F3/8":M1/2", F1/2":M3/4", F1/2":M3/8"
Contem: 980036A, 920037A, 920036A, 920030A, 920020A, 920021A, 920023A.		



Acessórios 3/8"		adaptador F3/8":M1/4"
Chaves caixa 1/4"	6 pontos	6, 7, 8, 10, 13mm
Chaves caixa 3/8"	6 pontos	8, 10, 11, 12, 13, 14, 16, 17, 19mm
Ch. cx. longas 3/8"	6 pontos	8, 10, 11, 12, 13, 14, 16, 17, 19mm

Contem: 980035, 960506, 960507, 960508, 960510, 960513, 980508, 980510, 980511, 980512, 980513, 980514, 980516, 980517, 980519, 980608, 980610, 980611, 980612, 980613, 980614, 980616, 980617, 980619.

Chaves caixa 1/2"	6 pontos	13, 15, 16, 17, 18, 19, 22, 24mm
Ch. cx. longas 1/2"	6 pontos	13, 15, 16, 17, 18, 19, 22, 24mm

Contem: 920513A, 920515A, 920516A, 920517A, 920518A, 920519A, 920522A, 920524A, 920613A, 920615A, 920616A, 920617A, 920618A, 920619A, 920622A, 920624A.

Chaves caixa 1/2"	6 pontos	13, 15, 16, 17, 18, 19, 22, 24mm
Ch. cx. longas 1/2"	6 pontos	13, 15, 16, 17, 18, 19, 22, 24mm
Pinos		20, 25mm
Anéis	Ø	20, 24mm

Contem: 920513, 920515, 920516, 920517, 920518, 920519, 920522, 920524, 920613, 920615, 920616, 920617, 920618, 920619, 920622, 920624.

Chaves caixa 1/2"	6 pontos	19, 21, 22, 24, 27, 30, 32mm
Ch. cx. longas 1/2"	6 pontos	19, 21, 22, 24, 27mm
Pinos		25mm
Anéis	Ø	24mm

Contem: 920519N1, 920521N1, 920522N, 920524N, 920527N, 920530N, 920532N, 920619N, 920621N, 920622N, 920624N, 920627N.

Barra torção	1/2"	90, 110, 120, 140Nm
Chave de rodas	1/2"	17, 19, 21mm
Adaptador		F3/8":M1/4"

Contem: 920517N, 920519N, 920521N, 923090, 923110, 923120, 923140, 980036.

TT-9024 | € 72,00

Tabuleiro TT 24 peças, ch impacto 3/8" E 1/4"

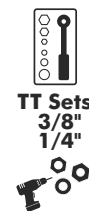

TT-9116N | € 84,00

Tabuleiro TT 16 peças, ch impacto 1/2".



TT-9120DN | € 111,00

Tabuleiro TT 20 peças, ch impacto, pinos e anéis de segurança 1/2". (com sistema de segurança)



TT-9212 | € 102,00

Tabuleiro TT 14 peças, ch impacto, pino e anél de segurança 1/2". (com sistema de segurança)

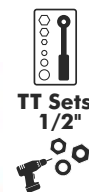

TT-TS08 | € 107,00

Tabuleiro TT 8 peças, chaves de rodas impacto 1/2".



TT-9015HX | € 149,00

Tabuleiro TT 15 peças, chaves impacto hex (com sistema de segurança)



TT Sets
3/8"
1/4"



Ponta hexagonal	3/8"	4, 5, 6, 7, 8, 10, 12mm
Ponta hexagonal	1/2"	5, 6, 8, 10, 12, 14, 17, 19mm

Contem: 981504, 981505, 981506, 981507, 981508, 981510, 981512, 921505, 921506, 921508, 921510, 921512, 921514, 921514, 921517.

TT-9212TX | € 133,00

Tabuleiro TT 15 peças, chaves impacto 1/2" TX (com sistema de segurança)



TT Sets
1/2"



Chaves caixa 1/2"	TX10, TX15, TX20, TX25, TX27, TX30, TX40, TX45, TX50, TX55, TX60, TX70
-------------------	--

Contem: 921210TX, 921215TX, 921220TX, 921225TX, 921227TX, 921230TX, 921240TX, 921240TX, 921250TX, 921255TX, 921260TX, 921270TX.

TTD-9416 | € 158,00

Tabuleiro TTD 16 peças, ch impacto 3/4". (com sistema de segurança)



TTD Sets
3/4"



Acessórios 3/4"	extensão 7", 3 pinos e 3 anéis retentores
-----------------	---

Chaves caixa 3/4"	6 pontos	19, 24, 27, 30, 32, 33, 34, 36, 38mm
-------------------	----------	--------------------------------------

Contem: 940022, O95036, P90435, 940519, 940524, 940527, 940530, 940532, 940533, 940534, 940536, 940538.

TTX-9415 | € 236,00

Tabuleiro TTX 15 peças, ch impacto 3/4". (com sistema de segurança)



TTX Sets
3/4"



Chaves caixa 3/4"	6 pontos	19, 24, 27, 28, 30, 32, 34, 36mm
-------------------	----------	----------------------------------

Ch. cx. longas 3/4"	6 pontos	19, 24, 27, 30, 32, 33, 36mm
---------------------	----------	------------------------------

Contem: 940519, 940524, 940527, 940528, 940530, 940532, 940534, 940536, 940619, 940624, 940627, 940628, 940630, 940632, 940634, 940536.

TT-ID20 | € 37,00

Tabuleiro TT 20 peças, impacto.



TT Sets



Acessórios	chave de bits reversível impacto, adaptador de acoplamento, adaptador HEX5/16":M 3/8".
------------	--

Bits 36mm	fenda 6, 8, 10, 12mm, PH1, PH2, PH3, PH4, Umbrako 5, 6, 8, TX30, TX40, TX45, TX50, TX55
-----------	---

Contem: 920060, 980086, 940006, 940008, 940010, 940012, 930001, 930002, 930003, 930004, 910504, 91050, 910506, 910508, 970030, 970040, 970045, 970050, 970055.



Acessórios	chave de bits reversível impacto 1/4", adaptador HEX1/4":M1/4"	
Extractores parafusos 1/4"	nº 1, 2, 3	
Chaves cx. impacto 1/4"	8, 10, 13mm	
Bits impacto 50mm		
Contem: M140508, M140510, M140513, IBA14, SE141, SE142, SE143,		

TT-ID19 | € 39,00
Tabuleiro TT 19 peças, impacto



Acessórios	1/4"	encabadouro magnético 60mm, encabadouro 60mm com sistema de encaixe rápido
Bits de caixa 65mm	1/4"	1/4", 8, 10, 13mm
Bits impacto 30mm	1/4" hex	PH1, PH2 (x 2), PH3, PZ1, PZ2 (x 2), PZ3, TX10, TX15, TX20 (x 2), TX25 (x 2), TX27, TX30 (x 2), TX 40, hexagonais 3, 4 (x 2) 5, 6mm, ROB1, 2, GR2 (x 2)
Bits impacto 50mm	1/4" hex	TX10, TX15, TX20, TX25, TX27, TX30, TX40, hexagonal 3, 4, 5, 6mm, ROB1, 2, 3, GR2
Bits impacto 89mm	1/4" hex	PH2, PZ2, TX20, TX25, TX30
Contem: MBH14, QCI14		

TTBS53 | € 92,00
Tabuleiro TT 53 peças, bits impacto.



Chave T	hex/bola	100mm	2.5, 3, 4mm
Chave T	hex/bola	150mm	5, 6, 7mm
Chave T	hex/bola	190mm	8mm
Contem: 5105025, 510503, 510504, 510505, 510506, 510507, 510508.			

TT-HEX7 | € 44,00
Tabuleiro TT, 7 chaves T ponta hexagonal/bola.



Chave T	hexagonal	100mm	2.5, 3, 4mm
Chave T	hexagonal	150mm	5, 6, 7mm
Chave T	hexagonal	190mm	8mm
Contem: 5106025, 510603, 510604, 510605, 510606, 510607, 510608.			

TT-HEX7S | € 44,00
Tabuleiro TT, 7 chaves T ponta hexagonal.



TT-HEX7AF | € 44,00

Tabuleiro TT, 7 chaves T ponta hexagonal/bola.



TT Sets



Chave T	hex/bola	100mm	3/32", 1/8", 5/32"
Chave T	hex/bola	150mm	3/16", 7/32", 1/4"
Chave T	hex/bola	190mm	5/16"

Contem: 510103, 510104, 510105, 510106, 510107, 510108, 510110.

TT-TX7 | € 40,00

Tabuleiro TT, 7 chaves T ponta TX/TPX.



TT Sets



Chave T	TX/TPX	100mm	TX/TPX10, TX/TPX15, TX/TPX20
Chave T	TX/TPX	150mm	TX/TPX25, TX/TPX27, TX/TPX30
Chave T	TX/TPX	190mm	TX/TPX40

Contem: 520010, 520015, 520020, 520025, 520027, 520030, 520040.

TT-HT28 | € 59,00

Tabuleiro TT 28 peças, chaves Umbrako.



TT Sets



Umbrako	mm	1.5, 2, 2.5, 3, 4, 5, 6, 7, 8, 10
	Polegadas	5/64", 3/32", 1/8", 5/32", 3/16", 7/32", 1/4", 5/16", 3/8"
	TX	TX8, TX9, TX10, TX15, TX20, TX25, TX27, TX30, TX40

Contem: 1479MMA, 1479AF, 1479TX.

TT-917N | € 41,00

Tabuleiro TT, 7 chaves de parafusos.



TT Sets



Ch. parafusos	fendas	3x75mm, 5.5x75mm, 6.5x100mm
	PH	PH0x75mm, PH1x75mm, PH2x100mm
	PZ	PZ2x100mm

Contem: MD920N, MD922N, MD928N1, MD940N, MD947N1, MD948N1, MD962N.

TT-917TXN | € 42,00

Tabuleiro TT, 7 chaves de parafusos TX e TPX.



TT Sets



Ch. parafusos	TX	TX8x75mm, TX9x75mm
	TPX	TPX10x100mm, TPX15x100mm, TPX20x100mm, TPX25x100mm, TPX30x100mm

Contem: MD908TN, MD909TN, MD610TPN, MD615TPN, MD620TPN, MD625TPN, MD630TPN.



Ch. parafusos	fendas	3x75mm, 3.5x100mm, 5.5x75mm, 5.5x125mm, coto 6.5x38mm, 6.5x100mm
	PH	PH0x75mm, PH1x75mm, coto PH2x38mm, PH2x100mm
	PZ	PZ2x100mm

Contem: MD916N1, MD920N, MD922N, MD928N, MD931N, MD932N, MD940N, MD947N1, MD948N, MD952N, MD960N, MD961N, MD962N2, MD962N3

Ch. parafusos	75mm	TX6, TX7, TX8, TX9
	100mm	TX10, TX15, TX20, TX25 TX27, TX30, TX40
	125mm	TX45

Contem: MD906TN, MD907TN, MD908TN, MD909TN, MD910TN, MD915TN, MD920TN, MD925TN, MD927TN, MD930TN, MD940TN, MD945TN.

Ch. parafusos	fendas 6.5 x 38mm, 3 x 100mm, 6.5 x 100mm, 10 x 200mm, 5.5 x 150mm, 8 x 150mm PH2 x 38mm, PH3 x 150mm
---------------	--

Contem: MD928N, MD920N, MD928N1, MD935N, MD923N, MD934N, MD948N, MD949N.

Ch. parafusos	fendas 6.5 x 100mm, 8 x 150mm, 10 x 200mm PH2 x 100mm, PH3 x 150mm
---------------	---

Contem: MDT932N, MDT934N, MDT935N, MDT952N, MDT935N.

Chaves de porcas	5, 5.5, 6, 7, 8, 10, 11, 12, 13mm
------------------	-----------------------------------

Contem: MDN505, MDN5055, MDN506, MDN507, MDN508, MDN510, MDN511, MDN512, MDN513.

TTD-914N | € 76,00

Tabuleiro TTD, 14 chaves de parafusos.



TTD Sets

TTD-912TXN | € 71,00

Tabuleiro TTD, 12 chaves de parafusos TX.



TTD Sets

TTX-918N | € 60,00

Tabuleiro TTX, 8 chaves de parafusos.



TTX Sets

TTX-MDTN | € 49,00

Tabuleiro TTX, 5 chaves de parafusos impacto.



TTX Sets

TTX-ND | € 84,00

Tabuleiro TTX, 9 chaves de porcas.



TTX Sets



Tabuleiros

TT-MD12D | € 42,00

Tabuleiro TT 12 peças, chaves de parafusos



TT Sets



Accessórios	1/4"	cabo com encabadouro 1/4"
Lâminas	1/4"	TX10 - TX15, TX20 - TX25, TX30 - TX40
	1/4"	Hex/bola 3.0 x Hex 3.0mm, Hex/bola 4.0 x Hex 4.0mm, Hex/bola 5.0 x Hex 5.0mm, Hex/bola 6.0 x Hex 6.0mm
	1/4"	PH1 x PH2, PH3 x fenda 6.5mm
	1/4"	fenda 4.0 x 5.5mm

Contem: TXX1015, TXX2025, TXX3040, HBH0303, HBH0404, HBH0505, HBH0606, PHH0102, PHF0365, FTF4055, MD901.

TT-MDQ38 | € 50,00

Tabuleiro TT 38 peças, chaves de bits



TT Sets



Accessórios	1/4"	Chaves de bits 147mm e 183mm com aperto rápido
Bits 25mm	1/4" hex	fendas 3.5, 5.5, 8mm, PH1, PH2, PH3, PZ1, PZ2, PZ3, TX10 TX15, TX20, TX25, TX30, TX40, hexagonais 2, 3, 4, 5, 6, 8mm, TPX20, TPX25, TPX30, ROB1, 2, 3
Bits 89mm	1/4" hex	fendas 3, 4mm, PH1, PH2, PZ1, PZ2, TX10, TX20, TX25

Contem: MDQ147, MDQ183,

TT-MD74 | € 49,00

Tabuleiro TT 74 peças, chaves de bits



TT Sets



Accessórios	1/4"	chave de bits com roquete (inclui 6 bits) extensão flexível 6", extensão 4", adaptador M1/4":HEX1/4", F1/4":HEX1/4"
Bits 25mm	1/4" hex	TX6, TX7, TX8, TX9, TX10, TX15, TX20(x3), TX25(x3), TX27, TX30, TX40, hexagonais 2, 3, 4, 5, 6, 8mm, TPX10, TPX15, TPX20(x2), TPX25(x2), TPX27, TPX30, TPX40, fendas 0.6x3.5, 0.6x4.5, 0.8x4.0, 0.8x5.5, 1.0x5.5, 1.2x5.0, 1.2x6.5, 1.4x7.0, 1.6x8.0mm, PH1(x4), PH2(x7), PH3, PZ1(x4), PZ2(x7), PZ3(x1), ROB1, 2, 3, GR2

Contem: MDR908, MDT74-1, MDT74-2, ACCSDA1414, M140060

TTX-MD41N | € 55,00

Tabuleiro TTX 41 peças, chave de bits flexíveis



TTX Sets



Accessórios	1/4"	chave de bits flexível 555mm(x2), adaptador HEX1/4":HEX1/4"
Chaves de caixa	1/4"	4, 4.5, 5, 5.5, 6, 7, 8, 9, 10, 11, 12, 13mm
Bits 25mm	1/4" hex	fendas 0.8x4.0, 1.0x5.5, 1.6x8.0mm, PH0, PH1, PH2, PH3, PH4, hexagonais 3, 4, 5, 6, 8, 10mm, PZ0, PZ1, PZ2, PZ3, TX8, TX10, TX15, TX20, TX25, TX27, TX30, TX40.

Contem: MD907FL, M140504, M1405045, M140505, M1405055, M140506, M140507, M140508, M140509, M140510, M140511, M140512, M140513,

TT-MI16 | € 90,00

Tabuleiro TT 16 peças, chaves de aparafusar de precisão e alicates de electrónica.



TT Sets



Ch. de precisão	fendas 2, 2.4, 3mm, PH00, PH0, PH1, TX6, TX7, TX8, TX9, TX10, TX15
Alicates electrónica	corte lateral 4 1/2", turquesa 4 1/2", pontas 5", pontas chatas 5"

Contem: MBM441, MBM449, MBM461, MBM464, MBM706, MDM706TX.



Alicates corte lateral 6", universal 7", pontas 8", bomba de água 10"

Contem: MB441-6, MB452-7, MB461-8, MB481-10.

Alicates corte lateral 6", universal 7", pontas 8", bomba de água 10"

Contem: MB441-6T, MB452-7T, MB461-8T, MB481-10T.

Alicates corte lateral 6", universal 7", pontas 8", bomba de água 10"

Contem: MB441-6, MB452-7, MB461-8, MB481-10Q.

Alicates corte lateral 6", universal 7", pontas 8", bomba de água 10"

Contem: MB441-6T, MB452-7T, MB461-8T, MB481-10TQ.

Chave crescente 10", alicate bomba de água 10"

Contem: 4003J, MB482-10Q.

TT-440 | € 74,00

Tabuleiro TT, 4 alicates.



TT Sets

TT-440-T | € 81,00

Tabuleiro TT, 4 alicates com pega ergonómica TPR.



TT Sets

TT-440-Q | € 78

Tabuleiro TT, 4 alicates com pega ergonómica TPR.



TT Sets

TT-440-TQ | € 84

Tabuleiro TT, 4 alicates com pega ergonómica TPR.



TT Sets

TTX-MB02 | € 67,00

Tabuleiro TTX 2 peças, chave crescente e alicate bomba de água.

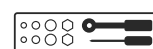

TTX Sets



TTD-441 | € 157,00

Tabuleiro TTD, 8 alicates .



TTD Sets



Alicates corte lateral 6" e 8", universal 6" e 8", pontas 6" e 8", bomba de água 7" e 10"

Contem: MB442-6, MB442-8, MB452-6, MB452-8, MB461-6, MB461-8, MB481-7, MB481-10.

TTD-441-T | € 170,00

Tabuleiro TT, 8 alicates com pega ergonómica TPR.



TTD Sets



Alicates corte lateral 6" e 8", universal 6" e 8", pontas 6" e 8", bomba de água 7" e 10"

Contem: MB442-6T, MB442-8T, MB452-6T, MB452-8T, MB461-6T, MB461-8T, MB481-7T, MB481-10T.

TTD-441-Q | € 162,00

Tabuleiro TT, 8 alicates com pega ergonómica TPR.



TTD Sets



Alicates corte lateral 6" e 8", universal 6" e 8", pontas 6" e 8", bomba de água 7" e 10"

Contem: MB442-6, MB442-8, MB452-8, MB452-6, MB461-6, MB461-8, MB482-7Q, MB482-10QT

TT-474-5 | € 61,00

Tabuleiro TT 4 peças, alicates de freios.



TT Sets



Alicates freios 5" interno/recto (capacidade de 10 a 25mm)
interno/curvo (capacidade de 10 a 25mm)
externo/recto (capacidade de 10 a 25mm)
externo/curvo (capacidade de 10 a 25mm)

Contem: MB470-5, MB471-5, MB472-5, MB473-5.

TT-474-5E | € 82,00

Tabuleiro TT 4 peças, alicates de freios.



TT Sets



Alicates freios 5" interno/recto (capacidade de 12 a 25mm)
interno/curvo (capacidade de 12 a 25mm)
externo/recto (capacidade de 12 a 25mm)
externo/curvo (capacidade de 12 a 25mm)

Contem: MBE470-5S, MBE471-5S, MBE472-5S, MBE473-5S.



Alicates freios 7"

interno/recto (capacidade de 19 a 60mm)
 interno/curvo (capacidade de 19 a 60mm)
 externo/recto (capacidade de 19 a 60mm)
 externo/curvo (capacidade de 19 a 60mm)

Contem: MB470-7, MB471-7, MB472-7, MB473-7.

Alicates freios 7"

interno/recto (capacidade de 19 a 60mm)
 interno/curvo (capacidade de 19 a 60mm)
 externo/recto (capacidade de 19 a 60mm)
 externo/curvo (capacidade de 19 a 60mm)

Contem: MBE470-7, MBE471-7, MBE472-7, MBE473-7.

Alicates freios 9"

interno/recto (capacidade de 40 a 100mm)
 interno/curvo (capacidade de 40 a 100mm)
 externo/recto (capacidade de 40 a 100mm)
 externo/curvo (capacidade de 40 a 100mm)

Contem: MB470-9, MB471-9, MB472-9, MB473-9.

Alicates freios 9"

interno/recto (capacidade de 40 a 100mm)
 interno/curvo (capacidade de 40 a 100mm)
 externo/recto (capacidade de 40 a 100mm)
 externo/curvo (capacidade de 40 a 100mm)

Contem: MBE470-9, MBE471-9, MBE472-9, MBE473-9.

TT-474-7 | € 67,00

Tabuleiro TT 4 peças, alicates de freios.



TT Sets

TT-474-7E | € 89,00

Tabuleiro TT 4 peças, alicates de freios.



TT Sets

TTX-474-9 | € 103,00

Tabuleiro TTX 4 peças, alicates de freios.

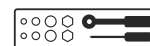

TTX Sets

TTX-474-9E | € 139,00

Tabuleiro TTX 4 peças, alicates de freios.



TTX Sets



TTVG05 | € 65,00

Tabuleiro TT 5 peças, alicates de fixação.



TT Sets



Alicates fixação 4", 7", 10", ponta longa 4" e 6"

Contem: 401-10, 401-4, 401-7, 404-4, 404-6.

TTZ-VG03 | € 39,00

Tabuleiro TTZ 3 peças, alicates fixação.



TTZ Sets



Alicates fixação 4", ponta longa 4" e 6"

Contem: 401-4, 404-4, 404-6.

TTP-SPG | € 76,00

Tabuleiro TTPS 4 peças, alicates fixação.



TTPS Sets



Alicates fixação 11" em C, 9" aperto de soldadura, 8" chapa metálica, 6" pontas longas

Contem: 408, 404-6, 407, 406.

TT-NF12 | € 33,00

Tabuleiro TT 12 peças, limas de precisão.



TT Sets



Limas murça, meia cana, triangular, quadrada, redonda, ponta plana, tipo faca, barra, cruzada, oval, aresta de pena, plana redonda

Contem: TTNF12-01, TTNF12-02, TTNF12-03, TTNF12-04, TTNF12-05, TTNF12-06, TTNF12-07, TTNF12-08, TTNF12-09, TTNF12-10, TTNF12-11, TTNF12-12.

TTX-F05 | € 55,00

Tabuleiro TTX 5 peças, limas



TTX Sets



Limas 10" plana, murça, meia cana, redonda, triangular

Contem: FLFT10, FLHF10, FLHR10, FLRD10, FLTR10.



Tesoura de chapa corte a direita, tesoura de chapa corte a esquerda, X-acto, tesoura de electricista, corta cabos capacidade 2AWG (14mm quadrados)

Contem: 491, 492, 496, 497, 710N.

Tesoura de chapa corte a direita, off set direita, off set esquerda, tesoura de electricista, riscador e raspador.

Contem: 491-7N, 493-7N, 494-7N, 497, SCR02, DET02.

X-actos	plástico 8 e 19mm, automático, dobrável lâmina fixa, mini x-acto dobrável
---------	---

Lâminas	fixa (x 5), mini fixa (x 10), 9mm (x 10), 18mm (x 10)
---------	---

Contem: 711, 712, P-UKF, 710F, 710C, 711-5, 710F-10, 710A-10, 710U-106.

Acessórios	extensão flexível 3", 10", adaptador com fução para barra T F1/2":M3/8", chave de caixa 3/8" 6 pontos 21mm
------------	--

Chave de velas 3/8"	16, 21mm
---------------------	----------

Chave para bujão	HEX5/16":HEX3/8", ■11mm:HEX12mm, HEX17mm:HEX1/2", ■8mm:■3/8", ■13mm:HEX14mm, HEX8mm:HEX10mm
------------------	---

Acessórios	chave para filtro de óleo, ferramenta de inspeção 3 em 1, apalpa folgas 21 lâminas (.005 mm - 1.0 mm)
------------	---

Contem: 582MI, 9110, DP12, FG21, M120036, M380020, M380022W, M380040, M380046, M380521.

Punções	centro 5 x 150mm
---------	------------------

	planas 3, 4, 5, 6, 7, 8mm (150mm)
--	-----------------------------------

Cinzeis	19 x 150mm, 25 x 200mm
---------	------------------------

Contem: CP05, PP03, PP04, PP05, PP06, PP07, PP08, CC150F, CC200F.

TTD-CT05 | € 108,00

Tabuleiro TTD 8 peças, ferramenta de corte.



TTD Sets

TTD-CT06 | € 115,00

Tabuleiro TTD 6 peças, ferramenta de corte.



TTD Sets

TT-K40 | € 60,00

Tabuleiro TT 40 peças, x-actos e lâminas subresselentes.



TT Sets

TT-OS16 | € 79,00

Tabuleiro TT 16 peças, kit manutenção auto.



TT Sets

TT-PC09 | € 56,00

Tabuleiro TT 9 peças, ferramenta de pancada.



TT Sets



TT-SR04 | € 32,00

Tabuleiro TT 4 peças de raspagem.



TT Sets



Contem: MD-SCR, MDA-R, MDH-L, MDH-S.

Raspador de juntas 245mm com lâmina 22mm, gancho curvo, gancho 90°, furador

TT-SR04A | € 29,00

Tabuleiro TT 4 peças de remoção.



TT Sets



Contem: MRP06, MRP95, MDR06, MDR08

Removedores de cliques e painéis: Tipo V x2 e tipo U x2

TT-MDP | € 20,00

Tabuleiro TT 4 peças de raspagem.



TT Sets



Gancho 35°, gancho 90°, gancho 125°, furador

Contem: MDA180, MDP90, MDP35, MDP125.

TT-804 | € 48,00

Tabuleiro TT 3 peças, extractor duas/três pernas .



TT Sets



Extractor combinado duplo/triplo 6", com pernas reversíveis e 4" capacidade

Contem: SPA11.

TT-SS07 | € 105,00

Tabuleiro TT 7 peças, chaves especiais auto.



TT Sets



AT350	29mm	1/2"	chave para sensor de oxigénio GM 90mm
AT355	22mm	3/8"	chave para sensor de oxigénio Mitsubishi, Nissan, Opel, Vauxhall e VW 90mm
AT360	27mm	1/2"	chave para Injector M24 85mm
AT365	7/8"	3/8"	chave para injectores 80mm
AT370	1 1/16"	3/8"	chave para sensor de óleo 74mm
AT375	7/8"	1/2"	chave para sensor de oxigénio 50mm
AT380	7/8"	3/8"	chave para sensor de oxigénio 30mm

Contem: AT350, AT355, AT360, AT365, AT370, AT375, AT380.



Alicates para mangueiras 1/4"-3/4", 1/4"-1 1/4", 3/4"-2 1/4"

Contem: AT080, AT085, AT090.

Acessórios Corta tubos 3-32mm (1/8" - 1/4") , Abocardador para tubos

Adaptadores 4, 4.75 (3/16"), 6 (1/4"), 8 (5/16"), 10,12, 14mm

Contem: TF30, restantes artigos não estão disponíveis em separado.

Extractores machos 1/2" 6, 8, 10, 12mm

parafusos 7/64", 9/64", 5/32", 1/4", 19/64"

porcas 5 a 20mm, 14 a 27mm

Contem: NS02, SE05, ST12506, ST12508, ST12510, ST12512.

Barra de força 12", 16" e 20"

Contem: PB12, PB16, PB20.

Barra de força 12", 18" e 22"

Contem: PB12A, PB18A, PB22A.

TT-HC03 | € 34,00

Tabuleiro TT 3 peças, alicates para mangueiras.



TT Sets

TT-TF10 | € 76,00

Tabuleiro TT 10 peças para corte de tubos.



TT Sets

TT-SN11 | € 80,00

Tabuleiro TT 11 peças, extractores.



TT Sets

TTX-PB3 | € 66,00

Tabuleiro TTX 3 peças, barras de força.



TTX Sets



TTX-PB3A | € 46,00

Tabuleiro TTX 3 peças, barras de força



TTX Sets



TT-CP121 | € 35,00

Tabuleiro TT 121 peças, alicate de terminais



TT Sets



Alicate	terminais multifunções
Treminais/ligadores	anel #6 vermelho (x 20), #8 azul (x 20), junção vermelha (x 20), azul (x 20), fêmea 6.3x0x8mm azul (x 20), macho 6.3x0x8mm azul (x 20)

Contem: CP50, terminais/conectores.

TT-CP04 | € 95,00

Tabuleiro TT 4 peças, alicate de terminais



TT Sets



Alicate terminais automático 22 - 10 AWG	
Cunho	para ligador não isolado aberto, tipo comercial 22 -12 AWG para terminais não isolados 22 - 8 AWG
Chave hexagonal 2.5mm	

Contem: CP52, CP04RK2, CP04RK3, 3105025.

TT-BE18 | € 355,00

Tabuleiro TT 18 peças, extractores de machos



TT Sets



Extractores machos	3/8"	6, 8, 10, 11, 12, 13, 14, 16, 17mm
	3/8"	5/16", 3/8", 7/16", 1/2", 9/16", 5/8"
	1/2"	19, 21, 22, 24, 25mm
	1/2"	3/4", 13/16", 7/8", 15/16", 1"
Punção plana	4 x 150mm	

Contem: ST38306, ST38308, ST38112, ST38310, ST38311, ST38312, ST38116, ST38313, ST38314, ST38316, ST38317, ST38122.

TT-TM03 | € 55,00

Tabuleiro TT 3 peças, ferramenta de inspeção.



TT Sets



Lupa telescópica, espelho de inspeção telescópico, apanhador magnético

Contem: 581TMG, 581TMI, 581TMP.

TT-TM08 | € 77,00

Tabuleiro TT 8 peças, ferramenta de inspeção.



TT Sets



Lanterna de LED, apanhador magnético flexível 300mm, apanhador magnético telescópico 160 - 400mm, lupa 1:3 de 38mm com adaptador magnético, espelho de 38mm com adaptador magnético, pá flexível de 230mm, Pilhas AAA(x 2).

Contem: MD920N, MD922N, MD928N1, MD940N, MD947N1, MD948N1, MD962N.



Brocas	1(x3), 1.5(x3), 2(x2), 2.5(x2), 3, 3.5, 4, 4.5, 5, 5.5, 6, 6.5, 7, 7.5, 8, 8.5, 9, 10, 10.5, 11, 12, 13mm
---------------	---

Contem: DBX010, DBX015, DBX020, DBX025, DBX030, DBX035, DBX040, DBX045, DBX050, DBX055, DBX060, DBX065, DBX070, DBX075, DBX080, DBX085, DBX090, DBX100, DBX110, DBX115, DBX120, DBX130.

Alicate de rebitar	manual, com quatro bocais para rebites cegos de alumínio/aço 2.4, 3.2, 4, 4.8mm
---------------------------	---

Rebites de alumínio	2.4mm (x 20), 3.2mm (x 20), 4mm (x 20), 4.8mm (x 15)
----------------------------	--

Acessórios	chave para bocal
-------------------	------------------

Contem: HR01, rebites.

Alicate de rebitar	manual, com quatro mandris de troca rápida M3x0.5, M4x0.7, M5x0.8, M6x1
---------------------------	---

Rebites de alumínio	M3 (x 20), M4 (x 20), M5 (x 20), M6 (x 15)
----------------------------	--

Acessórios	chave para bocal
-------------------	------------------

Contem: HN02, fixadores de porcas.

Caçonetos	3x0.5, 4x0.7, 5x0.8, 6x1, 8x1.25, 10x1.5, 12x1.75mm
------------------	---

Machos	3, 4, 5, 6, 8, 10, 12mm
---------------	-------------------------

Acessórios	desandador de machos 3 - 12mm, porta caçonetos 3 - 12mm, conta fios.
-------------------	--

Contem: SCPG, TDD03050, TDD04070, TDD05080, TDD06100, TDD08125, TDD10150, TDD12175, TDT03050, TDT04070, TDT05080, TDT06100, TDT08125, TDT10150,

Caçonetos	3x0.5, 4x0.7, 5x0.8, 6x1, 8x1.25, 10x1.5, 12x1.75mm
------------------	---

Machos	3, 4, 5, 6, 8, 10, 12mm
---------------	-------------------------

Brocas	2.5, 3.3, 4.2, 5.0, 6.8, 8.5, 10.5mm
---------------	--------------------------------------

Extractores	1/8", 3/16", 15/64", 5/16", 3/8"
--------------------	----------------------------------

Acessórios	chave de precisão 2.5 x 40mm, extensão 1/4", adaptador F3/8":M1/4", mini roquete 1/4", bucha para caçonetos 1/4", bucha para machos 1/4" (x 2 - M3-M8, M5-M12), conta fios.
-------------------	---

Contem: 1400M, DB118-025, DB118-033, DB118-042, DB118-050, DB118-068, DB118-085, DB118-105, M140021, M140070B, M140071B, M140072B, M380035-C, MDM712, SCPG, SEL01S, SEL02S, SEL03S, SEL04S, SEL05S, TDD03050, TDD04070, TDD05080, TDD06100, TDD08125, TDD10150, TDD12175, TDT03050, TDT04070, TDT05080, TDT06100, TDT08125, TDT10150, TDT12175.

TT-DB28 | € 86,00

Tabuleiro TT 28 peças, brocas metal ponta a 118°



TT Sets

TT-HR81 | € 73,00

Tabuleiro TT 81 peças, ferramenta para rebitar.



TT Sets

TT-NR81 | € 136,00

Tabuleiro TT 81 peças, ferramenta para rebitar.



TT Sets

TT-TD17 | € 57,00

Tabuleiro TT 17 peças, machos e matrizes.



TT Sets

TTD-TD34 | € 180,00

Tabuleiro TTD, machos e matrizes.



TTD Sets



TT-TC06 | € 100,00

Tabuleiro TT 6 peças, corta tubos e acessórios.



TT Sets



Corta tubos	10, 12, 15, 22mm, ajustável 3 - 22mm
Acessórios	rebarbador de lâmina giratório
Contem: TFA10, TFA12, TFA15, TFA22, TF30, DET01.	

TT-BM | € 73,00

Tabuleiro TT 4 peças, ferramenta de medição.



TT Sets



Ferramentas	paquímetro 150mm(6"), régua em aço 150mm, esquadro com base 100 x 70mm, riscador 150mm
Contem: CALV150, ST150, SQAB10070, SCR02.	

TTD-CM | € 132,00

Tabuleiro TTD 4 peças, ferramenta de medição.



TTD Sets



Ferramentas	paquímetro digital 150mm(6"), multimetro , 2 x apalpa folgas
Contem: CALD150, DM550, FG20100, TGMUNC	



Ferramentas

chaves ajustáveis de 6" e 10", alicate de fixação de 10", x-acto, serra 12", martelo duplo, fita métrica de 3metros, régua de aço de 200mm, martelo de pena de 800g

Contem: 4002, 4004, 401-10, 701, 710, HMEG800, HMSF, MT03, ST200.

Ferramentas

chaves ajustáveis de 6" e 10", alicate de fixação de 10", x-acto, serra 12", martelo duplo, fita métrica de 3metros, régua de aço de 200mm, martelo de bola de 24oz

Contem: 4002, 4004, 401-10, 701, 710, HMBP24, HMSF, MT03, ST200.

Ferramentas

chave crescente 8", alicate de fixação de 10", x-acto, armação de serra 12", fita métrica de 3metros, martelo de bola 16Oz

Contem: 4003, 401-10, 701, 710N, MT03, HMBP16.

Ferramentas

chave crescente 8", alicate de fixação de 10", x-acto, armação de serra 12", fita métrica de 3metros, martelo de pena 500g

Contem: 4003, 401-10, 701, 710N, MT03, HMEG500.

Martelos

anti-retorno 5 e 55mm, face redonda plana x pena recta, face redonda plana x pena pontiaguda, face redonda plana x face quadrada serrilhada

Contem: HMDH35, HMDH55, HMBH01, HMBH02, HMBH03.

TTP-S09E | € 148,00

Tabuleiro TTPS 9 peças, ferramenta diversa.

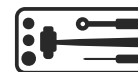

TTPS Sets

TTP-S09 | € 138,00

Tabuleiro TTPS 9 peças, ferramenta diversa.

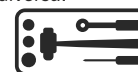

TTPS Sets

SCP-S01 | € 95,00

Tabuleiro TTPS 6 peças, ferramenta diversa.

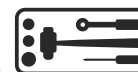

TTPS Sets

SCP-S01E | € 95,00

Tabuleiro TTPS 6 peças, ferramenta diversa.

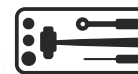

TTPS Sets

TTP-SAD | € 132,00

Tabuleiro TT 5 martelos.

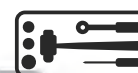

TTPS Sets



TTV-706N | € 39,00

Tabuleiro TT 6 peças, chaves isoladas 1000v.



TT Sets



Ch. parafusos Isoladas
(**lâmina estreita**)

fendas 0.8x4.0x100, 1.0x5.5x125mm
PH1x80, PH2x100mm
PZ1x80, PZ2x100mm

Contem: MDV724N, MDV726N, MDV742N, MDV744N, MDV762N, MDV764N.

TTV-907N | € 38,00

Tabuleiro TT 7 peças, chaves isoladas 1000v.



TT Sets



Ch. parafusos Isoladas

fendas 2.5x75mm, 4.0x100mm, 5.5x125mm
PH0 x 60mm, PH1 x 80mm, PH2 x 100mm
PZ2 x 100mm

Contem: MDV820N, MDV824N, MDV826N, MDV840N, MDV842N, MDV844N, MDV864N.

TTV-710N | € 40,00

Tabuleiro TT 10 peças, chaves isoladas 1000v.



TT Sets



Ch. parafusos Isoladas
(**lâmina substituível**)

fendas 3mm, 4mm, 5.5mm, 6.5mm
PH1, PH2
PZ1, PZ2

Cabos tamanho- L / tamanho-s

Contem: MDV700, MDV710, MDV731, MDV732, MDV733, MDV734, MDV751, MDV752, MDV771, MDV772

TTV-SD09 | € 121,00

Tabuleiro TT 9 peças, chaves isoladas 1000v.



TT Sets



Ch. parafusos Isoladas
(**lâmina substituível**)

fendas 3mm, 4mm, 5.5mm, 6.5mm
PH1, PH2
PZ1, PZ2

Cabo **Dinamométrico** 1-5 Nm

Contem: 1492TVSD, MDV731, MDV732, MDV733, MDV734, MDV751, MDV752, MDV771, MDV772

TTD-V910N | € 59,00

Tabuleiro TTD 10 peças. chaves isoladas 1000v.



TTD Sets



Ch. parafusos Isoladas

fendas 2.5x75mm, 3.0x100mm, 4.0x100mm, 5.5x125mm
PH0 x 60mm, PH1 x 80mm, PH2 x 100mm
PZ0x60mm, PZ1x80mm, PZ2 x 100mm

Contem: MDV820N, MDV822N, MDV824N, MDV826N, MDV840N, MDV842N, MDV844N, MDV860N, MDV862N, MDV864N.



Alicates 1000v corte lateral 6", universal 7", pontas 8", descascar fios 7"

Contem: MBV441-6, MBV451-7, MBV461-8, MBV499-7.

Acessórios 3/8"	Roquete + Extensões 75mm e 150mm		
Chaves caixa 3/8"	6 pontos	8, 9, 10, 11, 12, 13, 14, 15, 16, 17, 18, 19mm	

Contem: MV3800, MV380020, MV380021, MV38008, MV38009, MV380010, MV38011, MV38012, MV38013, MV38014, MV38015, MV38016, MV38017, MV38018, MV380019.

TTV-440 | € 92,00

Tabuleiro TT 4 peças, alicates isolados 1000v.



TT Sets



TTV-3814 | € 196,00

Tabuleiro TT 14 peças, alicates isolados 1000v.



TT Sets

Que testes recebe a nossa ferramenta isolada?

- Propriedades do isolamento, p.e. resistência até 1000 volts em ambientes secos e húmidos. ✓
- Resistência ao frio, p.e. como se comporta a ferramenta quando utilizada em temperaturas negativas. ✓
- Durabilidade, p.e. teste de stress ao manipulo das chaves de parafusos. ✓
- Resistência ao fogo, p.e. como se comporta a ferramenta quando em contacto com chamas ou calor extremo. ✓
- Propriedades de isolamento quando sujeita a pressão, p.e. como se comporta o isolamento da ferramenta quando esta é sujeita a pressão. ✓



TEA-01 | € 15,00

Tabuleiro TEA vazio

Inclui: tabuleiro EVA com 7 compartimentos.

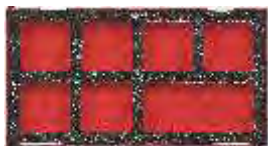

TEA Sets

**TEA-02 | € 13,50**

Tabuleiro TEA vazio

Inclui: tabuleiro EVA com 2 compartimentos.



TEA Sets

**TED-00 | € 25,00**

Tabuleiro TED vazio

Inclui: tabuleiro EVA com 4 compartimentos.

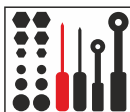

TED Sets

**TED-01 | € 25,00**

Tabuleiro TED vazio

Inclui: tabuleiro EVA com 8 compartimentos.

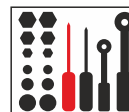

TED Sets

**TEX-02 | € 21,00**

Tabuleiro TEX vazio

Inclui: tabuleiro EVA com 4 compartimentos.



TEX Sets

**TEZ-01 | € 13,00**

Tabuleiro TEZ vazio

Inclui: tabuleiro EVA com 3 compartimentos.



TEZ Sets

**Tabuleiros TEZ**

Ch. Dinamométricas 1-5Nm - 4-25Nm

Contem: 1492TSD, 1492AGE

TEZ-SD02 | € 140,00

Tabuleiro TEZ com 2 peças



TEZ Sets

Alicates fixação 4", ponta longa 4" e 6"

Contem: 401-4, 404-4, 404-6.

TEZ-VZ03 | € 42,00

Tabuleiro TEZ com 3 peças



TEZ Sets



TEZ-MD06 | € 35,00

Tabuleiro TEZ com 6 peças



TEZ Sets



Chaves	fenda	38mm,
	estrela	ph1, ph2
	PZ	pz1, pz2

Contem: MD928N, MD947N, MD948N, MD961N2, MD962N3, MDBH

TEZ-SN06 | € 80,00

Tabuleiro TEZ com 6 peças



TEZ Sets



Extractores	machos 1/2"	6, 8, 10, 12mm
	porcas	5 a 20mm, 14 a 27mm

Contem: NS02, ST12506, ST12508, ST12510, ST12512.

Tabuleiros TEA

TEA-1487 | € 99,00

Tabuleiro TEA 14 peças 1/4"



**TEA Se+
1/4"**



roquete	mini reversível	
extensão	1/4" x 1/4"	fléxivel
extensão	1/4"	75mm
chaves caixa	1/4"	5.5 a 13mm

Contem: PM14, 691406, M140039, M140023-C, M1405055-C, M140506-C, M140507-C, M140508-C, M140509-C, M140510-C, M140511-C, M140512-C, M140513-C, M140108-C, M140110-C, M140112-C, M140606-C, M140607-C, M140608-C, M140609-C, M140610-C, M140611-C, M140612-C, M140613-C, Bits

TEA-MDQ78 | € 69,00

Tabuleiro TE 78 peças 1/4"



**TEA Sets
1/4"**



Acessórios	1/4"	chave de bits com roquete, adaptador magnético, cabeça de roquete, adaptador M1/4":HEX1/4"
Chaves de caixa	1/4"	4, 5, 9, 10, 11, 12, 13mm (sextavadas)

Contem: M140504, M140505, 140509, M140510, M140511, M140512, M140513, MDQ147, RHA14, M140037, ACC50MBH01

TEA-7203 | € 113,00

Tabuleiro TEA 3 peças 1/4"-3/8"-1/2"



**TEA Sets
1/4"
3/8"
1/2"**



Roquetes	1/4" 3/8" 1/2"	Articulados
----------	----------------------	-------------

Contem: 1400-72SN, 3800-72SN, 1200-72SN



Chaves	Impacto de 1/2"	3/8", 7/16", 1/2", 9/16", 5/8", 3/4", 13/16", 7/8", 1", 1-1/16", 1-1/8", 1-1/4"
--------	-----------------	---

Contem: 920112, 920114, 920116, 920118, 920120, 920124, 920126, 920128, 920132, 920134, 920136, 920140, O92194, O92244, P92320, P92325.

Chaves Longas	Impacto de 1/2"	7/16", 1/2", 9/16", 5/8", 11/16", 3/4", 13/16", 7/8", 15/16", 1"
---------------	-----------------	--

Contem: 920214, 920216, 920218, 920220, 920222, 920224, 920226, 920228, 920230, 920232, O92194, O92244, P92320, P92325.

Chaves	fenda	75mm, 175mm, 100mm, 150mm
--------	-------	---------------------------

Contem: MD917N, MD920N, MD922N, MD928N2

Chaves	estrela/Pz	Ph0, Ph1, Ph2, Pz1
--------	------------	--------------------

Contem: MD940N, MD947N1, MD948N1, MD961N

Chaves	Torx	TX10, TX15, TX20, TX25
--------	------	------------------------

Contem: MD910TN, MD915TN, MD920TN, MD925TN

TEA-9216AF | € 74,00

Tabuleiro TEA 12 peças impacto 1/2"



TEA Sets
1/2"



TEA-9214LAF | € 89,00

Tabuleiro TEA 10 peças impacto longas 1/2"



TEA Sets
1/2"

TEA-MD04N | € 28,00

Tabuleiro TEA 4 peças



TEA Sets

TEA-MD04N1 | € 28,00

Tabuleiro TEA 4 peças



TEA Sets

TEA-MD04TXN | € 31,00

Tabuleiro TEA 4 peças



TEA Sets



TEA-SD38 | € 100,00

Tabuleiro TEA 38 peças 1/4"



TEA Sets



Acessórios	adaptador 1/4" x 1/4"	
Chaves Dinamométrica	1 a 5Nm	
Contem: 1492TSD, M140039, bits		

TEA-BS50 | € 65,00

Tabuleiro TEA 50 peças, bits de impacto.



TEA Sets



Acessórios	1/4"	adaptador magnético, adaptador com bucha de encaixe rápido
Bits 30mm	1/4" hex	PH1, PH2, PH3, PZ1, PZ2, PZ3, ROB1, ROB2, hex. 3, 4, 5, 6mm, GR2, TX10, TX15, TX20, TX25, TX27, TX30, TX40
Bits 50mm	1/4" hex	PH1, PH2, PH3, PZ1, PZ2, PZ3, ROB1, ROB2, ROB3, hex. 3, 4, 5, 6mm, GR2, TX10, TX15, TX20, TX25, TX27, TX30, TX40

Contem: MBHI14, QCI14.

TEA-HR81 | € 79,00

Tabuleiro TEA 81 peças, alicates de rebitar.



TEA Sets



Acessórios	alicate de rebitar 250mm
Rebites	2,4, 3,2, 4, 4,8mm (x20 de cada)

Contem: HR01, rebites.

TEA-SR04A | € 61,00

Tabuleiro TEA 4 peças, removedores.



TEA Sets



Contem: MRP06, MRP95, MDR06, MDR08

Removedores de cliques e painéis: Tipo V x2 e tipo U x2

Tabuleiros TED

TED-1489 | € 122,00

Tabuleiro TED 80 peças 1/4"

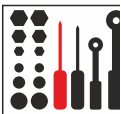

TED Sets
1/4"



Acessórios 1/4"	roquete rev 72 dentes, chave de aperto, extensões de 2"-4", junta universal, adaptador bits, adaptador F3/8":M1/4", adaptador M1/4":HEX1/4"	
Chaves de caixa 1/4"	6 pontos	4, 5, 5,5, 6, 7, 8, 9, 10, 11, 12, 13mm
Ch. cx. longas 1/4"	6 pontos	4, 5, 5,5, 6, 7, 8, 9, 10, 11, 13mm
Bits 1/4"		

Contem: 1400-72N, M140015, M140020, M140021, M140030, M140060, M380035, M140037, M140504, M140505, M1405055, M140506, M140507, M140508, M140509, M140510, M140511, M140512, M140513, M141404, M1414055, M141407, M141208T, M141210T, M141215T, M141220T, M141225T, M141227T, M141230T, M141240T, M141601, M141602, M141603, M141300, M141301, M141302, M141303, BITS.



Acessórios 3/8"		roquete reversível 72 dentes, chave de aparafusar, extensão flexível 3", junta universal, adaptador F1/2":M3/8"
Chaves de caixa 3/8"	6 pontos	8, 9, 10, 11, 12, 13, 14, 15, 16, 17, 18, 19, 22mm
Bits de caixa 3/8"		TX10, TX15, TX20, TX25, TX27, TX30, TX40, TX45, TX50, hexagonal 3, 4, 5, 5.5, 6, 7, 8, 10, 12mm
Contem: 3800-72N, M380015, M380020W, M380030, M120036, M380508, M380509, M380510, M380511, M380512, M380513, M380514, M380516, M380517, M380518, M380519, M380522.		

Acessórios 1/2"		roquete reversível 72 dentes, chave de aparafusar, extensões 2 1/2" e 6", junta universal, adaptador F3/8":M1/2"
Chaves de caixa 1/2"	12 pontos	10, 11, 12, 13, 14, 15, 16, 17, 18, 19, 22, 24mm
Ch. cx. longas 1/2"	12 pontos	10, 11, 12, 13, 14, 15, 16, 17, 18, 19mm

Contem: 1200-72N, M120020, M120023, M120030, M380036, M120510, M120511, M120512, M120513, M120514, M120515, M120516, M120517, M120518, M120519, M120522, M120524, M120610, M120611, M120612, M120613, M120614, M120615, M120616, M120617, M120618, M120619.

Acessórios 1/2"		extensões 3" e 10", junta universal, adaptador F3/8":M1/2" e F1/2":M3/4"
Chaves de caixa 1/2"	6 pontos	13, 15, 16, 17, 18, 19, 22, 24mm
Ch. cx. longas 1/2"	6 pontos	13, 15, 16, 17, 18, 19, 22, 24mm

Contem: 920020, 920023, 920030, 980036, 920037, 920513, 920515, 920516, 920517, 920518, 920522, 920524, 920613, 920615, 920616, 920617, 920618, 920619, 920622, 920624.

Acessórios 1/4"		extensões, adaptador
Acessórios 3/8"		extensões,
Chaves de Bits 1/4"		Hex, Torx, estrela
Chaves de Bits 3/8"		Hex, Torx, estrela

Contem: M140036-C, M141300-C, M141301-C, M141302-C, M141303-C, M141404-C, M1414055-C, M141407-C, M141601-C, M141602-C, M141603-C, M380020-C, M380035-C, M381104-C, M381105-C, M381106-C, M381107-C, M381108-C, M381110-C, M381112-C, M381210T-C, M381215T-C, M381220T-C, M381225T-C, M381227T-C, M381230T-C, M381240T-C, M381245T-C, M381250T-C, M381210-C, M381215-C, M381220-C, M381225-C, M381227-C, M381230-C, M381240-C, M381245-C, M381250-C, M381503-C, M381504-C, M381505-C, M3815055-C, M381506-C, M381507-C, M381508-C, M381510-C, M381512-C

Chaves de Bits 1/2"		Hex, Torx
----------------------------	--	-----------

Contem: M122220T-C, M122225T-C, M122227T-C, M122230T-C, M122240T-C, M122245T-C, M122250T-C, M122255T-C, M122260T-C, M122505-C, M122506-C, M122507-C, M122508-C, M122510-C, M122512-C, M122514-C, M122517-C

TED-3836 | € 120,00

Tabuleiro TED 36 peça 3/8"

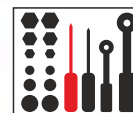
**TED Sets**
3/8"**TED-1227 | € 138,00**

Tabuleiro TED 27 peças 1/2"

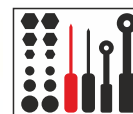
**TED Sets**
1/2"**TED-9121 | € 176,00**

Tabuleiro TED 21 peças impacto 1/2".

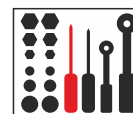
**TED Sets**
1/2"**TED-BS47 | € 143,00**

Tabuleiro TED 47 peças"

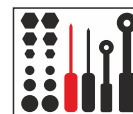
**TED Sets**
1/4"
3/8"**TED-LBS17 | € 110,00**

Tabuleiro TED 17 peças"

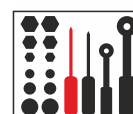
**TED Sets**

TED-SD14 | € 179,00

Tabuleiro TED 95 peças,

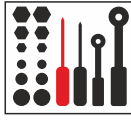

TED Sets
1/4"
3/8"
1/2"



Acessórios	1/4"	chave de bits dinâmometrica 1-5Nm, adaptador para bits com sistema de encaixe rápido, barra T deslizante, extensão flexível 6". Chave de bits com roquete e compartimento de bits (fendas 5, 7mm, PH1, PH2, PZ1, PZ2, adaptador M1/4":HEX1/4")
	3/8"	adaptador M3/8":HEX5/16"
	1/2"	chave impacto para bits, adaptador 5/16" hex.
Bits		
Contem: 1492STD, M140050, TTMD74-2, MDR908, 980086, ID506, 920060, Bits		

TED-6515 | € 100,00

Tabuleiro TED 15 peças, chaves boca/luneta.



TED Sets



Chaves boca/luneta	5.5, 6, 7, 8, 9, 10, 11, 12, 13, 14, 15, 16, 17, 18, 19mm
Contem: 6005055, 600506, 600507, 600508, 600509, 600510, 600511, 600512, 600513, 600514, 600515, 600616, 600617, 600618, 600619.	

TED-8012 | € 109,00

Tabuleiro TED 12 peças, chaves boca/luneta.

anti-deslizantes

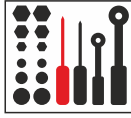

TED Sets



Chaves boca/luneta	8, 9, 10, 11, 12, 13, 14, 15, 16, 17, 18, 19mm
Contem: 800608, 800609, 800610, 800611, 800612, 800613, 800614, 800615, 800616, 800617, 800618, 800619.	

TED-6512R | € 275,00

Tabuleiro TED 12 peças, chaves boca/luneta

com roquete reversível



TED Sets



Chaves boca/luneta	8, 9, 10, 11, 12, 13, 14, 15, 16, 17, 18, 19mm
Contem: 600508R, 600509R, 600510R, 600511R, 600512R, 600513R, 600514R, 600515R, 600516R, 600517R, 600518R, 600519R.	

TED-6512RS | € 206,00

Tabuleiro TED 12 peças, chaves boca/luneta

roquete

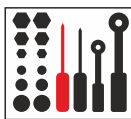

TED Sets



Chaves boca/luneta	8, 9, 10, 11, 12, 13, 14, 15, 16, 17, 18, 19mm
Contem: 600508RS, 600509RS, 600510RS, 600511RS, 600512RS, 600513RS, 600514RS, 600515RS, 600516RS, 600517RS, 600518RS, 600519RS.	



Chaves flexíveis M1/4" x HEX1/4", 8x9, 10x11, 12x13, 14x15, 16x17, 18x19

Contem: 691406, 650809, 651011, 651213, 651415, 651617, 651819.



TED-DF7 | € 132,00

Tabuleiro TED 7 peças, chaves flexíveis.

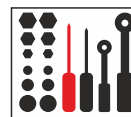

TED Sets



Ch. crescentes 6"(150mm), 8"(200mm), 10"(250mm) e 8" boca larga (200mm)
boca larga 8"(200mm)

Contem: 4002IQ, 4003IQ, 4004IQ, 4003WT.



TED-ADJ4 | € 114,00

Tabuleiro TED 4 peças, chaves crescentes.

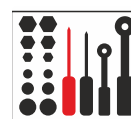

TED Sets

Chaves T hex. 2.5, 3, 4, 5, 6, 7, 8mm

Contem: 5105025, 510503, 510504, 510505, 510506, 510507, 510508.

TED-HEX7 | € 62,00

Tabuleiro TED 7 peças, chaves T hexagonais.

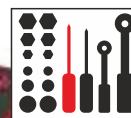

TED Sets

Chaves T TX10, TX15, TX20, TX25, TX27, TX30, TX40

Contem: 520010, 520015, 520020, 520025, 520027, 520030, 520040.

TED-TX7 | € 59,00

Tabuleiro TED 7 peças, chaves T torx.

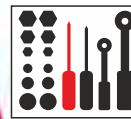

TED Sets

Cinzeis 19x150, 25x200, 25x250, 26x240mm

Punções centro 4, 5, 8mm, punção centro automática

Punções planas 3, 4, 5, 6, 7, 8mm

Contem: PP03, PP04, PP05, PP06, PP07, PP08, CP04, CP05, CP08, SCP01, CC150F, CC200F, CC250F, CC240F.

TED-PC14 | € 145,00

Tabuleiro TED 14 peças. ferramenta de bancada.

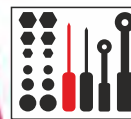

TED Sets



TED-911N | € 76,00

Tabuleiro TED 11 peças, chaves de parafusos.

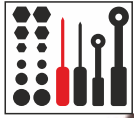

TED Sets



Ch. de parafusos	hexagonal	fenda	3.5x100, 5.5x75, 6.5x38mm
	cilindrica	fenda	5.5x125, 6.5x100mm
	hexagonal	PH	PH0x75, PH1x75, PH2x38mm
	cilindrica	PH	PH2x100mm
	hexagonal	PZ	PZ1x75mm
	cilindrica	PZ	PZ2x100mm

Contem: MD916N1, MD922N, MD931N, MD928N, MD928N1, MD940N, MD947N1, MD952N, MD960N, MD962N2.

TED-909TXN | € 69,00

Tabuleiro TED 9 peças, chaves de parafusos Torx.

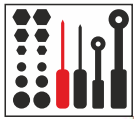

TED Sets



Ch. de parafusos	TX6, TX8, TX9, TX10, TX15, TX20, TX25, TX27, TX30
------------------	---

Contem: MD906TN, MD908TN, MD909TN, MD910TN, MD915TN, MD920TN, MD925TN, MD927TN, MD930TN.

TED-441-T | € 133,00

Tabuleiro TED 5 peças alicates

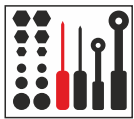

TED Sets



Alicates	5" corte lateral, 6" corte lateral, 8" combinado, 8"pontas longas, 10" bomba de água
----------	--

Contem: MB441-5T, MB442-6T, MB452-8T, MB461-8T, MB481-10T.

TED-441-Q | € 126,00

Tabuleiro TED 5 peças alicates

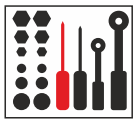

TED Sets



Alicates	5" corte lateral, 8" corte lateral, 8" combinado, 8"pontas longas, 10" bomba de água
----------	--

Contem: MB441-5, MB442-8, MB452-8, MB461-8, MB481-10q.

TED-441-TQ | € 134,00

Tabuleiro TED 5 peças alicates

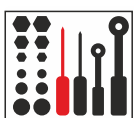

TED Sets



Alicates	5" corte lateral, 8" corte lateral, 8" combinado, 8"pontas longas, 10" bomba de água
----------	--

Contem: MB441-5T, MB442-8T, MB452-8T, MB461-8T, MB481-T10q.



Chaves umbrako	hex	1.5, 2, 2.5, 3, 4, 5, 6, 7, 8, 10mm
	hex	5/64", 3/32", 1/8", 5/32", 3/16", 7/32", 1/4", 5/16", 3/8"
	TX	TX8, TX9, TX10, TX15, TX20, TX25, TX27, TX30, TX40
Mini-chaves	TX	TX6, TX7, TX8, TX9, TX10, TX15
Jogo	hex	4, 5, 6mm, TX25, TX30, fenda 1.0x5.5mm, PH2, PZ2

Contem: 1479MM, 1479AF, 1479TX, 1477NX, MDM806T, MDM807T, MDM808T, MDM809T, MDM810T, MDM815T.

Paquímetro	gradação em mm e polegadas 150mm/6", intervalo 0.01mm
Micrometro	capacidade de medição de 0 a 25mm
Comparador	capacidade de medição de 0-25mm, intervalo 0.01mm, com suporte magnético articulado

Contem: CALD150, MIR25, DGMM.

Tesoura de chapa corte a direita, off set direita, off set esquerda, tesoura de electricista, riscador e raspador.

Contem: 491-7N, 493-7N, 494-7N, 497,SCR02, DET02.

TED-HT42 | € 103,00

Tabuleiro TED 42 peças.

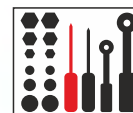

TED Sets

TED-IMM | € 261,00

Tabuleiro TED 3 peças.

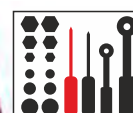

TED Sets

TED-CT06 | € 119,00

Tabuleiro TED 6 peças.

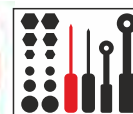

TED Sets

Tabuleiros TEX

Acessórios	1/4"	extensões de 6" e 12", junta universal
	3/8"	extensão 20" e flexível 3", junta universal, adaptador para barra T F3/8":M1/4"
	1/2"	extensão 20" e flexível 3", junta universal
		chaves de precisão 2 e 2.5mm, pega tipo T

Contem: M140022, M140024, M380024, M120024, M380020W, M120020W, M140030, M380030, M120030, M380035, T-HD, MDM711, MDM712.

Acessórios	adaptador barra T, pega tipo T
Chaves de velas 520mm	14, 16, 21mm
Contem:	TBUSB14, TBUSB16, TBUSB21, T-HD01, T-HD.

TEX-EXT13 | € 106,00

Tabuleiro TEX 13 peças.



TEX Sets

1/4"
3/8"
1/2"

TEX-TB05 | € 97,00

Tabuleiro TT 5 peças, chaves de velas e acessórios.



TEX Sets

3/8"



TEX-3403 | € 195,00

Tabuleiro TEX 3 peças, roquete e acessórios 3/4".



TEX Sets
3/4"



Roquete profissional, extensão 400mm e barra em T deslizante

Contem: M3400-72, 340022, 340050.

TEX-3410 | € 123,00

Tabuleiro TEX 10 peças, chaves de caixa 3/4".



TEX Sets
3/4"



Chaves de caixa 3/4" 6 pontos 22, 24, 27, 30, 32, 36, 38, 41, 46, 50mm

Contem: M3400-72, 340022, 340050.

TEX-1238 | € 123,00

Tabuleiro TEX 2 peças, chaves dinamométricas.



TEX Sets
1/2"



Chave dinamométrica 3/8" 20-110Nm (15-81ft/lb)

1/2" 40-210Nm (30-150ft/lb)

Contem: 1292AG-EP, MP1400.

TEX-MP12 | € 474,00

Tabuleiro TEX 2 peças, chave dinamométrica e multiplicador de força 1/2".



TEX Sets
1/2"



Chave dinamométrica 1/2" 40-210Nm (30-150ft/lb)

Multiplicador 1/2" F1/2":M3/4", rácio 3:1, torque máximo 1500Nm

Contem: 1292AG-EP, MP1400.

TEX-W05 | € 99,00

Tabuleiro TEX 5 peças, chaves de rodas.



TEX Sets
1/2"



Acessórios cabo articulado 17" (425mm), extensão impacto 5" (125mm)

Chaves de rodas 17, 19, 21mm

Contem: 1201, 920021-C, 920517N, 920519N, 920521N.



Barra de força	12", 16", 20"
Alavanca peneus	20"
Contem: PB12, PB16, PB20, AT20520.	

TEX-PB4 | € 107,00

Tabuleiro TEX 4 peças, barras de força.

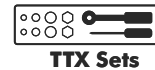

TTX Sets



Chaves boca/luneta	20, 21, 22, 24, 27, 30, 32mm
Contem: 600520, 600521, 600522, 600524, 600527, 600530, 600532.	

**TEX-2032 | € 109,00**

Tabuleiro TEX 7 peças, chaves boca/luneta.

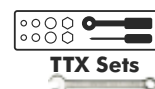

TTX Sets



Chaves luneta	6 x 7, 8 x 9, 10 x 11, 12 x 13, 14 x 15, 16 x 17, 18 x 19, 20 x 22mm
Contem: 630607, 630809, 631011, 631213, 631415, 631617, 631819, 632022.	

**TEX-6308 | € 80,00**

Tabuleiro TEX 8 peças, chaves luneta.



TTX Sets



Chaves luneta	8 x 10, 11 x 13, 12 x 14, 16 x 18, 17 x 19, 22 x 24mm
Contem: 630810FL, 631113FL, 631214FL, 631618FL, 631719FL, 632224FL.	

**TEX-FLS06 | € 187,00**

Tabuleiro TEX 6 peças, chaves luneta planas.

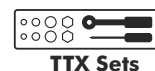

TTX Sets



Alicates	bomba de água 10"
Chaves	crencente 10"
Contem: MB482-10Q, 4003J.	

TEX-MB02 | € 82,00

Tabuleiro TEX 2 peças.



TTX Sets



TEX-915N | € 64,00

Tabuleiro TEX 5 peças, chaves de parafusos.



TEX Sets

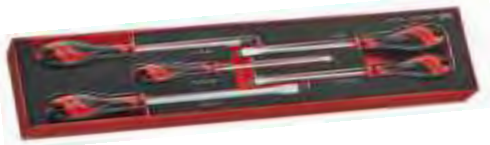

Ch. de parafusos	fenda	5.5x150, 6.5x150, 8x150, 10x200mm
	PH	PH3x150mm

Contem: MD923N, MD928N2, MD934N, MD935N, MD953N.

TEX-MDTN | € 58,00

Tabuleiro TEX 5 peças, chaves de parafusos impacto.



TEX Sets



Ch. de parafusos	PH	PH2 x 100mm, PH3 x 150mm
	fenda	6.5x100, 8x150, 10x200mm

Contem: MDT952N, MDT953N, MDT932N, MDT934N, MDT935N.

Tabuleiros TTEVA

TEF-SK57 | € 243,00

Tabuleiro TTEVA 57 peças.

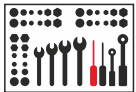

TTEVA Sets
1/4"
3/8"



Acessórios 1/4"		roquete reversível 72 dentes, extensões de 2" e 3", junta universal, adaptador para bits, adaptador F3/8":M1/4", adaptador HEX1/4":M1/4"
Chaves de caixa 1/4"	6 pontos	4, 5, 5.5, 6, 7, 8, 10, 11, 12, 13mm
Ch. cx. longas 1/4"	6 pontos	6, 7, 8, 10, 12, 13mm
Acessórios 3/8"		roquete reversível 72 dentes, extensões de 2" e 6", junta universal, adaptador para bits, adaptador F1/2":M3/8", chaves de velas 16 e 21mm
Chaves de caixa 3/8"	6 pontos	8, 9, 10, 11, 12, 13, 14, 15, 16, 17, 18, 19, 21, 22mm
Ch. boca/luneta		8, 9, 10, 11, 12, 13, 14, 15, 16, 17, 18, 19mm

Descrição das refs. conteúdo interno tabuleiros ver [página 106](#)

TTE-SK86 | € 398,00

Tabuleiro TTEVA 86 PEÇAS.

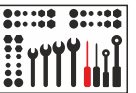

TTEVA Sets
1/4"
3/8"



Acessórios 1/4"		roquete reversível 72 dentes, extensões de 2", 3", 4", 6" e 12", junta universal, adaptador para bits, adaptador F1/4":M3/8", barra em T deslizante, manípulo tipo T, manivela, chave de aparafusar 6"
Chaves de caixa 1/4"	6 pontos	4, 4.5, 5, 5.5, 6, 7, 8, 9, 10, 11, 12, 13mm
Ch. cx. longas 1/4"	6 pontos	4, 5, 5.5, 6, 7, 8, 9, 10, 11, 12, 13mm
Acessórios 3/8"		roquete reversível 72 dentes, extensões de 3", 5", 6", 10" e 20", junta universal, adaptador para bits, adaptador F3/8":M1/4" e F3/8":M1/2", chaves de velas 16, 18 e 21mm, chave de apar 10", chave rotativa
Chaves de caixa 3/8"	6 pontos	7,8,9,10,11,12, 13, 14, 15, 16, 17, 18, 19, 20, 21,22mm
Ch. cx. longas 3/8"	6 pontos	7,8,9,10,11,12, 13, 14, 15, 16, 17, 18, 19, 20, 21,22mm

Descrição das refs. conteúdo interno tabuleiros ver [página 106](#)

TTE-SK126 | € 323,00

Tabuleiro TTEVA 126 peças.

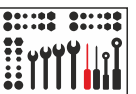

TTEVA Sets
1/4"
1/2"



Acessórios 1/4"		roquete FRP, mini roquete para bits, extensão de 4", junta universal, adaptador para bits, adaptador M1/4":HEX1/4", chave de aparafusar 6"
Chaves de caixa 1/4"	6 pontos	4, 4.5, 5, 5.5, 6, 7, 8, 9, 10, 11, 12, 13mm
Ch. cx. longas 1/4"	6 pontos	7, 8, 10, 11, 13mm
Acessórios 1/2"		roquete FRP, cabo articulado 17", extensões 5" e 10", junta universal, chaves de velas 16, 18, 21mm
Chaves de caixa 1/2"	6 pontos	10, 11, 12, 13, 14, 15, 16, 17, 18, 19, 20, 21, 24, 27, 30, 32, 34mm
Ch. cx. longas 1/2"	6 pontos	10, 13, 16, 17, 18, 19mm
Bits 25mm		

Descrição das refs. conteúdo interno tabuleiros ver [página 106](#)



Acessórios 1/2"		roquete reversível 72 dentes, manivela, barra em T deslizante, extensões 2 1/2", 5", 6" e 10", extensões flexíveis 3", 6", 10", junta universal, adaptador pª barra T F1/2":M3/8", adaptador F1/2":M3/4", adaptadores para bits de 5/16", 10 e 12mm, cabo articulado, chaves de velas 16, 18, 21mm
Chaves de caixa 1/2"	12 pontos	8, 9, 10, 11, 12, 13, 14, 15, 16, 17, 18, 19, 20, 21, 22, 24, 25, 26, 27, 28, 29, 30, 32, 34mm
Ch. cx. longas 1/2"	12 pontos	10, 11, 12, 13, 14, 15, 16, 17, 18, 19, 20, 21, 22, 24, 27, 30, 32, 36mm

Descrição das refs. conteúdo interno tabuleiros ver [página 106](#)

Acessórios 1/4"		roquete FRP, chave de aparafusar 6", extensões de 6" e 12", junta universal, adaptador barra T, pega T
Chaves de caixa 1/4"	6 pontos	4, 5, 5.5, 6, 7, 8, 9, 10, 11, 12, 13mm (longa 6-13mm)
Acessórios 3/8"		roquete FRP, extensão flexível 3", extensão 6", junta universal, adaptador F3/8":M1/4", adaptador F3/8":M1/2", chave rotativa
Chaves de caixa 3/8"	6 pontos	8, 9, 10, 11, 12, 13, 14, 15, 16, 17, 18, 19, 22mm.
Acessórios 1/2"	12 pontos	roquete FRP, extensão flexível 6", extensão 10", junta universal, adaptador F1/2":M3/8"
Ch. cx. impacto 1/2"	6 pontos	13, 15, 16, 17, 18, 19, 22, 24mm (longas mesma md)

Descrição das refs. conteúdo interno tabuleiros ver [página 106](#)

Acessórios 1/4"		roquete FRP, chave de aparafusar 6", extensões de 6" e 12", junta universal, adaptador barra T, pega T
Chaves de caixa 1/4"	6 pontos	5 a 13mm (longa 6 a 13mm)
Acessórios 2/2"		roquete FRP, extensão 3", extensão 6", junta universal
Chaves de caixa 1/2"	6 pontos	6 a 13mm (longa 6-13mm)

Descrição das refs. conteúdo interno tabuleiros ver [página 106](#)

Ch. boca/luneta		5/16", 3/8", 7/16", 1/2", 9/16", 5/8", 11/16", 3/4", 13/16", 7/8", 15/16", 1", 1 1/8", 1 1/4", 1 1/2"
Chaves caixa 1/4"	6 pts	3/16", 7/32", 1/4", 9/32", 5/16", 11/32", 3/8", 7/16", 1/2"
Ch. cx. longa 1/4"	6 pts	3/16", 7/32", 1/4", 9/32", 5/16", 11/32", 3/8", 7/16", 1/2"
Chaves caixa 3/8"	6 pts	3/8", 7/16", 1/2", 9/16", 5/8", 11/16", 3/4"
Ch. cx. longa 3/8"	6 pts	3/8", 7/16", 1/2", 9/16", 5/8", 11/16", 3/4"
Chaves caixa 1/2"	12 pts	3/8", 7/16", 1/2", 9/16", 5/8", 11/16", 3/4", 13/16", 7/8", 15/16", 1", 1 1/8", 1 1/4", 1 1/2"

Descrição das refs. conteúdo interno tabuleiros ver [página 106](#)

Acessórios 3/4"		roquete 72 dentes, barra am T deslizante, extensão 16", cabo articulado 19" (com sistema de segurança)
Chaves de cx. 3/4"	6 pt.	19, 21, 22, 24, 27, 30, 32, 33, 34, 36, 38, 41, 46, 50mm
	12 pt.	7/8", 15/16", 1", 1 1/8", 1 1/4", 1 1/2", 1 3/4", 1 7/8", 2", 2 1/4", 2 1/2", 2 3/4", 3", 3 1/4", 3 1/2", 3 3/4", 4", 4 1/4", 4 1/2", 4 3/4", 5", 5 1/4", 5 1/2", 5 3/4", 6", 6 1/4", 6 1/2", 6 3/4", 7", 7 1/4", 7 1/2", 7 3/4", 8", 8 1/4", 8 1/2", 8 3/4", 9", 9 1/4", 9 1/2", 9 3/4", 10", 10 1/4", 10 1/2", 10 3/4", 11", 11 1/4", 11 1/2", 11 3/4", 12", 12 1/4", 12 1/2", 12 3/4", 13", 13 1/4", 13 1/2", 13 3/4", 14", 14 1/4", 14 1/2", 14 3/4", 15", 15 1/4", 15 1/2", 15 3/4", 16", 16 1/4", 16 1/2", 16 3/4", 17", 17 1/4", 17 1/2", 17 3/4", 18", 18 1/4", 18 1/2", 18 3/4", 19", 19 1/4", 19 1/2", 19 3/4", 20", 20 1/4", 20 1/2", 20 3/4", 21", 21 1/4", 21 1/2", 21 3/4", 22", 22 1/4", 22 1/2", 22 3/4", 23", 23 1/4", 23 1/2", 23 3/4", 24", 24 1/4", 24 1/2", 24 3/4", 25", 25 1/4", 25 1/2", 25 3/4", 26", 26 1/4", 26 1/2", 26 3/4", 27", 27 1/4", 27 1/2", 27 3/4", 28", 28 1/4", 28 1/2", 28 3/4", 29", 29 1/4", 29 1/2", 29 3/4", 30", 30 1/4", 30 1/2", 30 3/4", 31", 31 1/4", 31 1/2", 31 3/4", 32", 32 1/4", 32 1/2", 32 3/4", 33", 33 1/4", 33 1/2", 33 3/4", 34", 34 1/4", 34 1/2", 34 3/4", 35", 35 1/4", 35 1/2", 35 3/4", 36", 36 1/4", 36 1/2", 36 3/4", 37", 37 1/4", 37 1/2", 37 3/4", 38", 38 1/4", 38 1/2", 38 3/4", 39", 39 1/4", 39 1/2", 39 3/4", 40", 40 1/4", 40 1/2", 40 3/4", 41", 41 1/4", 41 1/2", 41 3/4", 42", 42 1/4", 42 1/2", 42 3/4", 43", 43 1/4", 43 1/2", 43 3/4", 44", 44 1/4", 44 1/2", 44 3/4", 45", 45 1/4", 45 1/2", 45 3/4", 46", 46 1/4", 46 1/2", 46 3/4", 47", 47 1/4", 47 1/2", 47 3/4", 48", 48 1/4", 48 1/2", 48 3/4", 49", 49 1/4", 49 1/2", 49 3/4", 50", 50 1/4", 50 1/2", 50 3/4", 51", 51 1/4", 51 1/2", 51 3/4", 52", 52 1/4", 52 1/2", 52 3/4", 53", 53 1/4", 53 1/2", 53 3/4", 54", 54 1/4", 54 1/2", 54 3/4", 55", 55 1/4", 55 1/2", 55 3/4", 56", 56 1/4", 56 1/2", 56 3/4", 57", 57 1/4", 57 1/2", 57 3/4", 58", 58 1/4", 58 1/2", 58 3/4", 59", 59 1/4", 59 1/2", 59 3/4", 60", 60 1/4", 60 1/2", 60 3/4", 61", 61 1/4", 61 1/2", 61 3/4", 62", 62 1/4", 62 1/2", 62 3/4", 63", 63 1/4", 63 1/2", 63 3/4", 64", 64 1/4", 64 1/2", 64 3/4", 65", 65 1/4", 65 1/2", 65 3/4", 66", 66 1/4", 66 1/2", 66 3/4", 67", 67 1/4", 67 1/2", 67 3/4", 68", 68 1/4", 68 1/2", 68 3/4", 69", 69 1/4", 69 1/2", 69 3/4", 70", 70 1/4", 70 1/2", 70 3/4", 71", 71 1/4", 71 1/2", 71 3/4", 72", 72 1/4", 72 1/2", 72 3/4", 73", 73 1/4", 73 1/2", 73 3/4", 74", 74 1/4", 74 1/2", 74 3/4", 75", 75 1/4", 75 1/2", 75 3/4", 76", 76 1/4", 76 1/2", 76 3/4", 77", 77 1/4", 77 1/2", 77 3/4", 78", 78 1/4", 78 1/2", 78 3/4", 79", 79 1/4", 79 1/2", 79 3/4", 80", 80 1/4", 80 1/2", 80 3/4", 81", 81 1/4", 81 1/2", 81 3/4", 82", 82 1/4", 82 1/2", 82 3/4", 83", 83 1/4", 83 1/2", 83 3/4", 84", 84 1/4", 84 1/2", 84 3/4", 85", 85 1/4", 85 1/2", 85 3/4", 86", 86 1/4", 86 1/2", 86 3/4", 87", 87 1/4", 87 1/2", 87 3/4", 88", 88 1/4", 88 1/2", 88 3/4", 89", 89 1/4", 89 1/2", 89 3/4", 90", 90 1/4", 90 1/2", 90 3/4", 91", 91 1/4", 91 1/2", 91 3/4", 92", 92 1/4", 92 1/2", 92 3/4", 93", 93 1/4", 93 1/2", 93 3/4", 94", 94 1/4", 94 1/2", 94 3/4", 95", 95 1/4", 95 1/2", 95 3/4", 96", 96 1/4", 96 1/2", 96 3/4", 97", 97 1/4", 97 1/2", 97 3/4", 98", 98 1/4", 98 1/2", 98 3/4", 99", 99 1/4", 99 1/2", 99 3/4", 100", 100 1/4", 100 1/2", 100 3/4", 101", 101 1/4", 101 1/2", 101 3/4", 102", 102 1/4", 102 1/2", 102 3/4", 103", 103 1/4", 103 1/2", 103 3/4", 104", 104 1/4", 104 1/2", 104 3/4", 105", 105 1/4", 105 1/2", 105 3/4", 106", 106 1/4", 106 1/2", 106 3/4", 107", 107 1/4", 107 1/2", 107 3/4", 108", 108 1/4", 108 1/2", 108 3/4", 109", 109 1/4", 109 1/2", 109 3/4", 110", 110 1/4", 110 1/2", 110 3/4", 111", 111 1/4", 111 1/2", 111 3/4", 112", 112 1/4", 112 1/2", 112 3/4", 113", 113 1/4", 113 1/2", 113 3/4", 114", 114 1/4", 114 1/2", 114 3/4", 115", 115 1/4", 115 1/2", 115 3/4", 116", 116 1/4", 116 1/2", 116 3/4", 117", 117 1/4", 117 1/2", 117 3/4", 118", 118 1/4", 118 1/2", 118 3/4", 119", 119 1/4", 119 1/2", 119 3/4", 120", 120 1/4", 120 1/2", 120 3/4", 121", 121 1/4", 121 1/2", 121 3/4", 122", 122 1/4", 122 1/2", 122 3/4", 123", 123 1/4", 123 1/2", 123 3/4", 124", 124 1/4", 124 1/2", 124 3/4", 125", 125 1/4", 125 1/2", 125 3/4", 126", 126 1/4", 126 1/2", 126 3/4", 127", 127 1/4", 127 1/2", 127 3/4", 128", 128 1/4", 128 1/2", 128 3/4", 129", 129 1/4", 129 1/2", 129 3/4", 130", 130 1/4", 130 1/2", 130 3/4", 131", 131 1/4", 131 1/2", 131 3/4", 132", 132 1/4", 132 1/2", 132 3/4", 133", 133 1/4", 133 1/2", 133 3/4", 134", 134 1/4", 134 1/2", 134 3/4", 135", 135 1/4", 135 1/2", 135 3/4", 136", 136 1/4", 136 1/2", 136 3/4", 137", 137 1/4", 137 1/2", 137 3/4", 138", 138 1/4", 138 1/2", 138 3/4", 139", 139 1/4", 139 1/2", 139 3/4", 140", 140 1/4", 140 1/2", 140 3/4", 141", 141 1/4", 141 1/2", 141 3/4", 142", 142 1/4", 142 1/2", 142 3/4", 143", 143 1/4", 143 1/2", 143 3/4", 144", 144 1/4", 144 1/2", 144 3/4", 145", 145 1/4", 145 1/2", 145 3/4", 146", 146 1/4", 146 1/2", 146 3/4", 147", 147 1/4", 147 1/2", 147 3/4", 148", 148 1/4", 148 1/2", 148 3/4", 149", 149 1/4", 149 1/2", 149 3/4", 150", 150 1/4", 150 1/2", 150 3/4", 151", 151 1/4", 151 1/2", 151 3/4", 152", 152 1/4", 152 1/2", 152 3/4", 153", 153 1/4", 153 1/2", 153 3/4", 154", 154 1/4", 154 1/2", 154 3/4", 155", 155 1/4", 155 1/2", 155 3/4", 156", 156 1/4", 156 1/2", 156 3/4", 157", 157 1/4", 157 1/2", 157 3/4", 158", 158 1/4", 158 1/2", 158 3/4", 159", 159 1/4", 159 1/2", 159 3/4", 160", 160 1/4", 160 1/2", 160 3/4", 161", 161 1/4", 161 1/2", 161 3/4", 162", 162 1/4", 162 1/2", 162 3/4", 163", 163 1/4", 163 1/2", 163 3/4", 164", 164 1/4", 164 1/2", 164 3/4", 165", 165 1/4", 165 1/2", 165 3/4", 166", 166 1/4", 166 1/2", 166 3/4", 167", 167 1/4", 167 1/2", 167 3/4", 168", 168 1/4", 168 1/2", 168 3/4", 169", 169 1/4", 169 1/2", 169 3/4", 170", 170 1/4", 170 1/2", 170 3/4", 171", 171 1/4", 171 1/2", 171 3/4", 172", 172 1/4", 172 1/2", 172 3/4", 173", 173 1/4", 173 1/2", 173 3/4", 174", 174 1/4", 174 1/2", 174 3/4", 175", 175 1/4", 175 1/2", 175 3/4", 176", 176 1/4", 176 1/2", 176 3/4", 177", 177 1/4", 177 1/2", 177 3/4", 178", 178 1/4", 178 1/2", 178 3/4", 179", 179 1/4", 179 1/2", 179 3/4", 180", 180 1/4", 180 1/2", 180 3/4", 181", 181 1/4", 181 1/2", 181 3/4", 182", 182 1/4", 182 1/2", 182 3/4", 183", 183 1/4", 183 1/2", 183 3/4", 184", 184 1/4", 184 1/2", 184 3/4", 185", 185 1/4", 185 1/2", 185 3/4", 186", 186 1/4", 186 1/2", 186 3/4", 187", 187 1/4", 187 1/2", 187 3/4", 188", 188 1/4", 188 1/2", 188 3/4", 189", 189 1/4", 189 1/2", 189 3/4", 190", 190 1/4", 190 1/2", 190 3/4", 191", 191 1/4", 191 1/2", 191 3/4", 192", 192 1/4", 192 1/2", 192 3/4", 193", 193 1/4", 193 1/2", 193 3/4", 194", 194 1/4", 194 1/2", 194 3/4", 195", 195 1/4", 195 1/2", 195 3/4", 196", 196 1/4", 196 1/2", 196 3/4", 197", 197 1/4", 197 1/2", 197 3/4", 198", 198 1/4", 198 1/2", 198 3/4", 199", 199 1/4", 199 1/2", 199 3/4", 200", 200 1/4", 200 1/2", 200 3/4", 201", 201 1/4", 201 1/2", 201 3/4", 202", 202 1/4", 202 1/2", 202 3/4", 203", 203 1/4", 203 1/2", 203 3/4", 204", 204 1/4", 204 1/2", 204 3/4", 205", 205 1/4", 205 1/2", 205 3/4", 206", 206 1/4", 206 1/2", 206 3/4", 207", 207 1/4", 207 1/2", 207 3/4", 208", 208 1/4", 208 1/2", 208 3/4", 209", 209 1/4", 209 1/2", 209 3/4", 210", 210 1/4", 210 1/2", 210 3/4", 211", 211 1/4", 211 1/2", 211 3/4", 212", 212 1/4", 212 1/2", 212 3/4", 213", 213 1/4", 213 1/2", 213 3/4", 214", 214 1/4", 214 1/2", 214 3/4", 215", 215 1/4", 215 1/2", 215 3/4", 216", 216 1/4", 216 1/2", 216 3/4", 217", 217 1/4", 217 1/2", 217 3/4", 218", 218 1/4", 218 1/2", 218 3/4", 219", 219 1/4", 219 1/2", 219 3/4", 220", 220 1/4", 220 1/2", 220 3/4", 221", 221 1/4", 221 1/2", 221 3/4", 222", 222 1/4", 222 1/2", 222 3/4", 223", 223 1/4", 223 1/2", 223 3/4", 224", 224 1/4", 224 1/2", 224 3/4", 225", 225 1/4", 225 1/2", 225 3/4", 226", 226 1/4", 226 1/2", 226 3/4", 227", 227 1/4", 227 1/2", 227 3/4", 228", 228 1/4", 228 1/2", 228 3/4", 229", 229 1/4", 229 1/2", 229 3/4", 230", 230 1/4", 230 1/2", 230 3/4", 231", 231 1/4", 231 1/2", 231 3/4", 232", 232 1/4", 232 1/2", 232 3/4", 233", 233 1/4", 233 1/2", 233 3/4", 234", 234 1/4", 234 1/2", 234 3/4", 235", 235 1/4", 235 1/2", 235 3/4", 236", 236 1/4", 236 1/2", 236 3/4", 237", 237 1/4", 237 1/2", 237 3/4", 238", 238 1/4", 238 1/2", 238 3/4", 239", 239 1/4", 239 1/2", 239 3/4", 240", 240 1/4", 240 1/2", 240 3/4", 241", 241 1/4", 241 1/2", 241 3/4", 242", 242 1/4", 242 1/2", 242 3/4", 243", 243 1/4", 243 1/2", 243 3/4", 244", 244 1/4", 244 1/2", 244 3/4", 245", 245 1/4", 245 1/2", 245 3/4", 246", 246 1/4", 246 1/2", 246 3/4", 247", 247 1/4", 247 1/2", 247 3/4", 248", 248 1/4", 248 1/2", 248 3/4", 249", 249 1/4", 249 1/2", 249 3/4", 250", 250 1/4", 250 1/2", 250 3/4", 251", 251 1/4", 251 1/2", 251 3/4", 252", 252 1/4", 252 1/2", 252 3/4", 253", 253 1/4", 253 1/2", 253 3/4", 254", 254 1/4", 254 1/2", 254 3/4", 255", 255 1/4", 255 1/2", 255 3/4", 256", 256 1/4", 256 1/2", 256 3/4", 257", 257 1/4", 257 1/2", 257 3/4", 258", 258 1/4", 258 1/2", 258 3/4", 259", 259 1/4", 259 1/2", 259 3/4", 260", 260 1/4", 260 1/2", 260 3/4", 261", 261 1/4", 261 1/2", 261 3/4", 262", 262 1/4", 262 1/2", 262 3/4", 263", 263 1/4", 263 1/2", 263 3/4", 264", 264 1/4", 264 1/2", 264 3/4", 265", 265 1/4", 265 1/2", 265 3/4", 266", 266 1/4", 266 1/2", 266 3/4", 267", 267 1/4", 267 1/2", 267 3/4", 268", 268 1/4", 268 1/2", 268 3/4", 269", 269 1/4", 269 1/2", 269 3/4", 270", 270 1/4", 270 1/2", 270 3/4", 271", 271 1/4", 271 1/2", 271 3/4", 272", 272 1/4", 272 1/2", 272 3/4", 273", 273 1/4", 273 1/2", 273 3/4", 274", 274 1/4", 274 1/2", 274 3/4", 275", 275 1/4", 275 1/2", 275 3/4", 276", 276 1/4", 276 1/2", 276 3/4", 277", 277 1/4", 277 1/2", 277 3/4", 278", 278 1/4", 278 1/2", 278 3/4", 279", 279 1/4", 279 1/2", 279 3/4", 280", 280 1/4", 280 1/2", 280 3/4", 281", 281 1/4", 281 1/2", 281 3/4", 282", 282 1/4", 282 1/2", 282 3/4", 283", 283 1/4", 283 1/2", 283 3/4", 284", 284 1/4", 284 1/2", 284 3/4", 285", 285 1/4", 285 1/2", 285 3/4", 286", 286 1/4", 286 1/2", 286 3/4", 287", 287 1/4", 287 1/2", 287 3/4", 288", 288 1/4", 288 1/2", 288 3/4", 289", 289 1/4", 289 1/2", 289 3/4", 290", 290 1/4", 290 1/2", 290 3/4", 291", 291 1/4", 291 1/2", 291 3/4", 292", 292 1/4", 292 1/2", 292 3/4", 293", 293 1/4", 293 1/2", 293 3/4", 294", 294 1/4", 294 1/2", 294 3/4", 295", 295 1/4", 295 1/2", 295 3/4", 296", 296 1/4", 296 1/2", 296 3/4", 297", 297 1/4", 297 1/2", 297 3/4", 298", 298 1/4", 298 1/2", 298 3/4", 299", 299 1/4", 299 1/2", 299 3/4", 300", 300 1/4", 300 1/2", 300 3/4", 301", 301 1/4", 301 1/2", 301 3/4", 302", 302 1/4", 302 1/2", 302 3/4", 303", 303 1/4", 303 1/2", 303 3/4", 304", 304 1/4", 304 1/2", 304 3/4", 305", 305 1/4", 305 1/2", 305 3/4", 306", 306 1/4", 306 1/2", 306 3/4", 307", 307 1/4", 307 1/2", 307 3/4", 308", 308 1/4", 308 1/2", 308 3/4", 309", 309 1/4", 309 1/2", 309 3/4", 310", 310 1/4", 310 1/2", 310 3/4", 311", 311 1/4", 311 1/2", 311 3/4", 312", 312 1/4", 312 1/2", 312 3/4", 313", 313 1/4", 313 1/2", 313 3/4", 314", 314 1/4", 314 1/2", 314 3/4", 315", 315 1/4", 315 1/2", 315 3/4", 316", 316 1/4", 316 1/2", 316 3/4", 317", 317 1/4", 317 1/2", 317 3/4", 318", 318 1/4", 318 1/2", 318 3/4", 319", 319 1/4", 319 1/2", 319 3/4", 320", 320 1/4", 320 1/2", 320 3/4", 321", 321 1/4", 321 1/2", 321 3/4", 322", 322 1/4", 322 1/2", 322 3/4", 323", 323 1/4", 323 1/2", 323 3/4", 324", 324 1/4", 324 1/2", 324 3/4", 325", 325 1/4", 325 1/2", 325 3/4", 326", 326 1/4", 326 1/2", 326 3/4", 327", 327 1/4", 327 1/2", 327 3/4", 328", 328 1/4", 328 1/2", 328 3/4", 329", 3

TTE-ISK73 | € 522,00

Tabuleiro TTEVA 73 peças, mpacto.



TTEVA Sets
3/8"
1/2"

Acessórios 3/8"		extensão 3", adaptador F3/8":M1/4" e F3/8":M1/2", adaptador para bits
Chaves de caixa 3/8"	6 pontos	8, 10, 11, 12, 13, 14, 15, 16, 17, 18, 19mm
Ch. cx. longas 3/8"	6 pontos	8, 10, 11, 12, 13, 14, 16, 17, 19mm
Acessórios 1/2"		extensões 3", 5" e 10", junta universal, adaptador F1/2":M3/4" e F1/2":M3/8", adaptador para bits 5/16"
Chaves de caixa 1/2"	6 pontos	8, 9, 10, 11, 12, 13, 14, 15, 16, 17, 18, 19, 22mm.
Ch. cx. longas 1/2"	6 pontos	roquete FRP, extensão flexível 6", extensão 10", junta universal, adaptador F1/2":M3/8"

Descrição das refs. conteúdo interno tabuleiros ver [página 106](#)

TTE-ISK33 | € 656,00

Tabuleiro TTEVA 33 peças impacto 3/4".



TTEVA Sets
3/4"

Acessórios 3/4"		extensão 7", adaptador F3/4":M1/2" e F3/4":M1"
Chaves de caixa 3/4"	6 pontos	19, 21, 22, 23, 24, 27, 28, 30, 32, 33, 34, 36, 38, 41, 46mm
Ch. cx. longas 3/4"	6 pontos	19, 21, 22, 23, 24, 27, 30, 32, 33, 34, 36, 38, 41, 46mm

Descrição das refs. conteúdo interno tabuleiros ver [página 106](#)

TTE-SK85 | € 348,00

Tabuleiro TTEVA 85 peças, bits de caixa.



TTEVA Sets
1/4"
3/8"
1/2"

Acessórios	3/8"	extensão 3"
Bits caixa	1/4"	fendas 4, 5.5, 7mm, Pz1, Pz2, Pz3, TX-E4, E5, E6, E7, E8, PH0, PH1, PH2, PH3, TX10, TX15, TX20, TX25, TX27, TX30, TX40
	3/8"	TX10, TX15, TX20, TX25, TX27, TX30, TX40, TX45, TX50, TX-E10, E12, E14, E16, E18, TPX10, TPX15, TPX20, TPX25, TPX27, TPX30, TPX40, TPX45, TPX50, hex. 3, 4, 5.5, 6, 7, 8, 10, 12mm
	1/2"	TX20, TX25, TX27, TX30, TX40, TX45, TX50, TX55, TX60, hex. 5, 6, 7, 8, 10, 12mm, XZN5, XZN6, XZN8, XZN10, XZN12, XZN14, XZN16, Ribe Nº 4, 5, 6, 8, 10, 11, 12, 13.

Descrição das refs. conteúdo interno tabuleiros ver [página 106](#)

TTE-X32 | € 355,00

Tabuleiro TTEVA 32 peças.



TTEVA Sets

Chaves boca/luneta	8, 9, 10, 11, 12, 13, 14, 15, 16, 17, 18, 19, 20, 21, 22, 24, 27, 30, 32mm
Ch. boca/luneta R	8, 10, 11, 12, 13, 14, 17, 19mm
Limas 10"	murça, grossa, meia cana, redonda, triangular

Contem: 600508, 600509, 600510, 600511, 600512, 600513, 600514, 600515, 600516, 600517, 600518, 600519, 600520, 600521, 600522, 600524, 600527, 600530, 600532, 600508R, 600510R, 600511R, 600512R, 600513R, 600514R, 600517R, 600519R, FLT10, FLHF10, FLHR10, FLRD10, FLTR10.

TTE-SP31 | € 400,00

Tabuleiro TTEVA 31 peças, chaves boca/luneta.

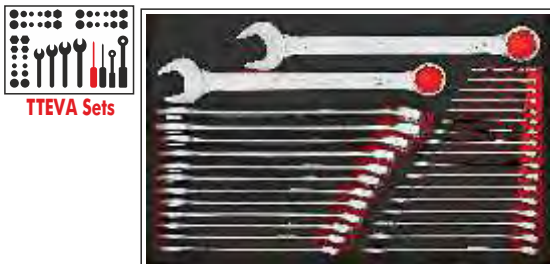

TTEVA Sets

Chaves boca/luneta	5.5, 6, 7, 8, 9, 10, 11, 12, 13, 14, 15, 16, 17, 18, 19, 20, 21, 22, 23, 24, 25, 26, 27, 28, 29, 30, 32, 33, 34, 36, 38mm
--------------------	---

Contem: 6005055, 600506, 600510, 600511, 600512, 600513, 600514, 600515, 600516, 600517, 600518, 600519, 600520, 600521, 600522, 600523, 600524, 600525, 600526, 600527, 600528, 600529, 600530, 600532, 600533, 600534, 600536, 600538.



Chaves boca/luneta	8, 9, 10, 11, 12, 13, 14, 15, 16, 17, 18, 19, 22, 24, 27mm
Chaves de bocas	6x7, 8x9, 10x11, 12x13, 14x15, 16x17, 18x19, 20x22, 21x23, 24x27, 30x32mm
Chaves luneta	6x7, 8x9, 10x11, 12x13, 14x15, 16x17, 18x19, 20x22, 21x23, 24x27, 30x32mm

Contem: 600508R, 600509R, 600510R, 600511R, 600512R, 600513R, 600514R, 600515R, 600516R, 600517R, 600518R, 600519R, 600522R, 600524R, 600527R, 620607, 620809, 621011, 621213, 621415, 621617, 621819, 622022, 622123, 622427, 623032, 630607, 630809, 631011, 631213, 631415, 631617, 631819, 632022, 632123, 632427, 633032.

Chaves boca/luneta	8, 9, 10, 11, 12, 13, 14, 15, 16, 17, 18, 19mm
Chaves umbrako	1.5, 2, 2.5, 3, 4, 5, 6, 8, 10mm
Chaves fenda/estrela	75mm x2, 100, 150, ph1, ph2, tpx 10-15-20-25-30

Contem: 1479MM, 600508, 600510, 600511, 600512, 600513, 600514, 600515, 600516, 600517, 600518, 600519, MD915N, MD916N1, MD917N, MD923N, MD947N1, MD948N1, MD908TN, MD909TN, MD610TPN, MD615TPN, MD620TPN, MD625TPN, MD630TPN.

Ch. parafusos	fendas	2.5x75, 3.5x75, 3.0x100, 4.0x100, 5.5x75mm, 5.5x150, 6.5x38, 6.5x100, 6.5x150, 8.0x150, 10.0x200mm
	PH	PH0x75, PH1x38, PH1x75, PH2x38, PH2x100, PH3x150, PH4x200mm
	PZ	PZ0x75, PZ1x38, PZ1x100, PZ2x38, PZ2x100, PZ2x150, PZ3x150mm
Acessórios	1/4" hex	chave de bits com roquete 6 em 1, bases para bits 25mm

Contem: MD915N, MD920N1, MD916N, MD917N, MD922N, MD923N, MD928N, MD928N1, MD928N2, MD934N, MD935N, MD940N, MD947N, MD947N1, MD948N, MD948N1, MD949N, MD950N, MD960N, MD961N2, MD961N3, MD962N3, MD962N, MD962N1, MD963N, MDR908, BITS.

Chaves	boca/luneta	8, 10, 11, 12, 13, 14, 15, 16, 17, 18, 19mm
	crescente	8"
	umbrako	1.5, 2, 2.5, 3, 4, 5, 6, 8, 10mm
	aparafusar	fenda 3.5 x 75, 5.5 x 150mm, PH1 x 75, PH2 x 100, PZ1 x 75, PZ2 x 100mm
Acessórios		sonda flexível com garra

Contem: 600508, 600510, 600511, 600512, 600513, 600514, 600515, 600516, 600517, 600518, 600519, 4003, 1479MM, MD916N, MD923N, MD947N1, MD948N1, MD961N, MD962N, AT135.

Ch. porcas		5, 5.5, 6, 7, 8, 10, 11, 12, 13mm
Chaves T	hex	2.5, 3, 4, 5, 6, 7, 8mm
	TX/TPX	T10, T15, T20, T25, T27, T30, T40

Contem: MDN405, MDN4055, MDN406, MDN407, MDN408, MDN410, MDN411, MDN412, MDN413, 5105025, 510503, 510504, 510505, 510506, 510507, 510508, 510510, 520010, 520015, 520020, 520025, 520027, 520030, 520040.

TTE-SP37 | € 633,00

Tabuleiro TTEVA 37 peças.



TTEVA Sets

TTE-MD33 | € 182,00

Tabuleiro TTEVA 33 peças.



TTEVA Sets

TTE-MD122N | € 290,00

Tabuleiro TTEVA 122 peças.



TTEVA Sets

TTE-SP28 | € 185,00

Tabuleiro TTEVA 28 peças.



TTEVA Sets

TTE-X23N | € 225,00

Tabuleiro TTEVA 23 peças.



TTEVA Sets



TTE-MB17 | € 349,00

Tabuleiro TTEVA 17 peças, alicates.

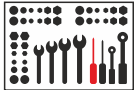

TTEVA Sets



Alicates

5" e 6" corte lateral, 6" e 8" cabeça longa corte lateral, 8" cabeça curva corte lateral, 8" corta cabos, 7" e 8" combinado, 8" pontas longas, 6" pontas chatas, 7" freios interno/recto, interno/curvo, externo/recto, externo/curvo, 7" e 10" bomba de água, 7" descarnador

Contem: MB441-5T, MB441-6T, MB442-6T, MB442-8T, MB442B-8T, MB444-8T, MB452-7T, MB452-8T, MB461-8T, MB464-6T, MB470-7, MB471-7, MB472-7, MB473-7, MB481-7T, MB481-10T, MB499-7T.

TTE-MB13Q | € 295,00

Tabuleiro TTEVA 13 peças

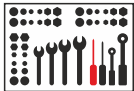

TTEVA Sets



Alicates

6" corte lateral, 6" corta arame, 7" universal, 8" pontas longas, 7" freios interno/recto, interno/curvo, externo/recto, externo/curvo, 4", 6 e 10" alicate fixação, 10" bomba de água, 8" corta rebites

Contem: MB441-6, MB444-6, MB452-7, MB461-8, MB482-10Q, MBE470-7, MBE471-7, MBE472-7, MBE473-7, BC408, 401-4, 401-10, 404-6

TTE-MB11 | € 234,00

Tabuleiro TTEVA 11 peças, alicates.

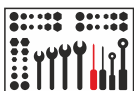

TTEVA Sets



Alicates

8" corte lateral, 7" combinado, 8" pontas longas, 10" bomba de água 7" freios interno/recto, interno/curvo, externo/recto, externo/curvo, fixação 4", 10", pontas longas 6"

Contem: MB442-8T, MB452-7T, MB461-8T, MB481-10T, MB470-7, MB471-7, MB472-7, MB473-7, 401-4, 401-10, 404-6.

TTE-MB14Q | € 323,00

Tabuleiro TTEVA 14 peças

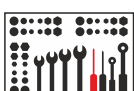

TTEVA Sets

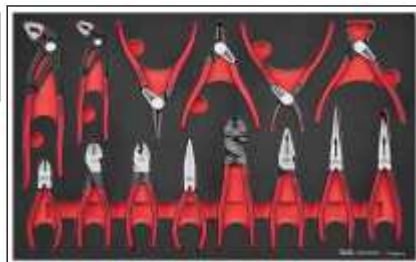

Alicates

5" e 6" corte lateral, 6" corta arame, 7" universal, 8" pontas longas, 8" pontas longas curvas, 7" freios interno/recto, interno/curvo, externo/recto, externo/curvo, 4", 6 e 10" alicate fixação, 7" e 10" bomba de água, 8" corta rebites

Contem: MB441-5, MB442-6, MB444-6, MB452-7, MB461-8, MB463-8, MB464-6, MB482-7Q, MB482-10Q, MBE470-7, MBE471-7, MBE472-7, MBE473-7, BC408

TTE-VG11 | € 242,00

Tabuleiro TTEVA 11 peças, alicates de fixação.

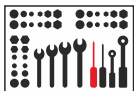

TTEVA Sets



Alicates

4", 5", 6", 10", pontas chatas 10", 12", pontas longas 4", 6", 9", tipo grampo 11", 12"

Contem: 401-4, 401-7, 401-10, 401-12, 401-10F, 401-12F, 404-4, 404-6, 404-9, 406P, 409SP.



Ch. dinamométrica	1/2"	40-210Nm (30-150ft/lb)
Chaves T	hex	2.5, 3, 4, 5, 6, 7, 8mm
Jogo		hex 4, 5, 6mm, TX25, TX30, fendas 5.5mm, PH1, PZ2
Ch. umbrako	hex/bol/TX	1.5, 2, 2.5, 3, 4, 5, 6, 7, 8, 10mm - Tx 8 a Tx40
F. de inspeção		apanhador magnético, lupa, espelho 57cm (todos telescópicos, extensíveis até 85cm), mini-lanterna

Contem: 1292AG-EP, 5105025, 510503, 510504, 510505, 510506, 510507, 510508, 510510, 1477NX, 1479MM, 310507BL, 1479TX, 581TMP, 581TMG, 581TMI, TM149.

Alicates	6" corte lateral 1000v, 8" pontas longas 1000v, 2 de terminais, 1 cravador.
outros	tesoura e busca-polos

Contem: CP58, CP60, CTG01, MDV9855, 497, MBV441-6, MBV461-8

Ch. umbrako	hex-bola	1.5, 2, 2.5, 3, 4, 5, 6, 7, 10mm
	TX	TX8, TX9, TX10, TX15, TX20, TX25, TX27, TX30, TX40
Ch. de parafusos		fendas 6.5 x 100mm, PH2 x 100mm, PZ2 X 100mm
Ch. 1,000v		fendas 4.0 x 101mm, PH1 x 81mm, PZ1 x 81mm
Bits 25mm		fendas 5, 5.5, 8mm, PH1, PH2, PH3, PZ1, PZ2, PZ3, TX10, TX15, TX20, TX25, TX30, TX40, TPX20, TPX25, TPX30, hex 2, 3, 4, 5, 6, 8, ROB1, 2, 3
Acessórios		chave de bits flexível, chave bits 100mm, fita 5m

Contem: 1479TX, 1479MMA, MD503NA, MDQ217, MT05MM, MDV724N, MDV742N, MDV762N, MD932N, MD948N1, MD962N,

Ch. umbrako	hex-bola	1.5, 2, 2.5, 3, 4, 5, 6, 7, 10mm
	TX	TX8, TX9, TX10, TX15, TX20, TX25, TX27, TX30, TX40
Ch. de parafusos		fendas 6.5 x 100mm, PH2 x 100mm, PZ2 X 100mm
Ch. 1,000v		fendas 4.0 x 101mm, PH1 x 81mm, PZ1 x 81mm
Bits 25mm		fendas 5, 5.5, 8mm, PH1, PH2, PH3, PZ1, PZ2, PZ3, TX10, TX15, TX20, TX25, TX30, TX40, TPX20, TPX25, TPX30, hex 2, 3, 4, 5, 6, 8, ROB1, 2, 3
Acessórios		chave de bits flexível, chave bits 100mm, fita 5m

Contem: MT05, 1479MMA, 1479TX, MD932N, MD948N1, MD962N, MDV724N, MDV762N, MDV742N, MD503NA, MDQ217

Ch. parafusos	TX/TPX	TX8 e TX9 - tpx10 a tpx30
Ch. Impacto	fend/Est	6.5x100, 8x150, 10x200mm / PH2x100, PH3x150mm
Ch. 1,000v	fen/ph/pz	2.5x75, 4x100, 5.5x125mm, ph0 - ph1 - ph2 - pz2
Mini-chaves	fend/Est	2.0x40, 2.5x40, 3.0x40mm / PH00x40, PH0x40, PH1x40mm
Mini-chaves	TX	TX6, TX7, TX8, TX9, TX10, TX15
Acessórios		chave bits 1/4" roquete reversível (magnetizador, bases para bits, adaptador M1/4":HEX1/4", adaptador para bits

Contem: MD908TN, MD909TN, MD610TPN, MD615TPN, MD620TPN, MD625TPN, MD630TPN, MDT932N, MDT934N, MDT935N, MDT952N, MDT953N, MDV820N, MDV824N, MDV826N, MDV840N, MDV842N, MDV844N, MDV864N, MDM713, MDM714, MDM715, MDM716, MDM717, MDM718, MDM 806, MDM807, MDM808, MDM809, MDM810, MDM815, MDR908, M140060-C, TTMD74-2.

TTE-X17 | € 270,00

Tabuleiro TTEVA 17 peças.



TTEVA Sets



TEX-07A | € 201,00

Tabuleiro TTEVA 7 peças



TTEVA Sets



TEF-MD54 | € 131,00

Tabuleiro TTEVA 54 peças.



TTEVA Sets

TEF-MDI54 | € 137,00

Tabuleiro TTEVA 54 peças



TTEVA Sets

TTE-MD98N | € 247,00

Tabuleiro TTEVA 98 peças.

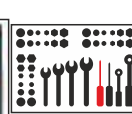

TTEVA Sets



TTE-PS12 | € 221,00

Tabuleiro TTEVA 12 peças.

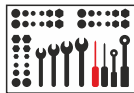

TTEVA Sets



F. de corte	armação de serra 12", x-acto
F. de pancada	martelo batente de borracha, martelo engenheiro 800g, jogo punções planas (3, 4, 5, 6, 7, 8mm), punção de centrar 5x150mm, cinzeis 18x150 e 25x200mm
Chaves	crescentes 6" e 10"
F. de medição	fita métrica 3m, régua em aço 200mm

Contem: 710, 701, HMEG800, HMSF, CC150F, CC200F, CP05, PP03, PP04, PP05, PP06, PP07, PP08, 4002IQ, 4004IQ, MT03, ST200.

TTE-PS15 | € 249,00

Tabuleiro TTEVA 15 peças.

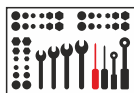

TTEVA Sets



F. de corte	armação de serra 12", serra
F. de pancada	martelo engenheiro 800g, jogo punções planas (3, 4, 5, 6, 7, 8mm), punção de centrar 200mm
Alicates	cutor 6", pontas 8", universal 8", bomba d'água 10"
F. de medição	fita métrica 3m

Contem: MB442-8T, MB452-8T, MB461-8T, MB481-10T, 701N1, 712, MT03MM, CC250F, PPS06, HMEG800

TTE-PS25 | € 222,00

Tabuleiro TTEVA 25 peças.

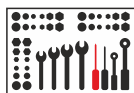

TTEVA Sets



F. de corte	armação de serra 12", x-acto 18mm (inclui 10 lâminas)
F. de pancada	martelo batente de borracha, martelo engenheiro 500g, jogo punções planas (3, 4, 5, 6, 7, 8mm)
Alicates	cutor lateral 6", universal 7", pontas 6", bomba de água 10"
F. de medição	fita métrica 3m

Contem : 701, 710C, HMSF, HMEG500, PPS06, MB441-6, MB452-7, MB461-6, MB481-10, MT03.

TEF-MB7 | € 164,00

Tabuleiro TTEVA 7 peças.

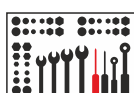

TTEVA Sets



Alicates	cutor lateral 6", pontas 8", bomba de água 10"
Chaves	crescente 8"
F. de corte	x-acto, tesoura corte chapa (a direito)
Martelo	carpinteiro 16oz

Contem : MB441-6T, MB461-8T, MB481-10, 4003WT, 490W, 710, HMCH16A.

TEF-MBP7 | € 166,00

Tabuleiro TTEVA 7 peças

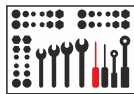

TTEVA Sets



Alicates	cutor lateral 6", pontas 8", bomba de água 10"
Chaves	crescente 8"
F. de corte	x-acto, tesoura corte chapa (a direito)
Martelo	bola 16oz

Contem: MB441-6T, MB461-8T, MB481-10, 4003WT, 490W, 710, HMBP16.



Alicates	corte lateral 6", pontas 8", bomba de água 10"
Chaves	crescente 8"
F. de corte	x-acto, tesoura corte chapa (a direito)
Martelo	pena 300
Contem : MB441-6T, MB461-8T, MB481-10, 4003WT, 490W, 710, HMEG300	

TEF-MBP7E | € 165,00

Tabuleiro TTEVA 7 peças



Alicates	bomba de água 10"
Chaves	crescente 8"
F. de corte	x-actos, serra
Martelo	bola 300
Contem : HMBP16, 4003WT, 710, 710A, 704, MB482-10Q	

TEF-X06 | € 116,00

Tabuleiro TTEVA 6 peças



Alicates	bomba de água 10"
Chaves	crescente 8"
F. de corte	x-actos, serra
Martelo	pena 300
Contem : HMEG300, 4003WT, 710, 710A, 704, MB482-10Q	

TEF-X06E | € 115,00

Tabuleiro TTEVA 6 peças.



Alicates	bomba de água 10"
Chaves	crescente 8"
F. de corte	serra
Outros	paquimetro, nivel, corta tubos deburador
Contem : 704, ,CALV150, SLT01, TF30, DET01, 4003WT, MB482-10Q	

TEF-X07 | € 185,00

Tabuleiro TTEVA 7 peças



Contem TEF-SK57: M1400-72N, M140020, M140023, M380035, M140037, M140030, M140060, M140504, M140505, M1405055, M140506, M140507, M140508, M140510, M140511, M140512, M140513, M140606, M140607, M140608, M140610, M140612, M140613, M3800-72N, M380020, M380021, M380030, M380036, M380060, TBUSP16, TBUSP21, M38050, M380509, M380510, M380511, M380512, M380513, M380514, M380515, M380516, M380517, M380518, M380519, M380521, M380522, 600508, 600509, 600510, 600511, 600512, 600513, 600514, 600515, 600516, 600517, 600518, 600519.

Contem TTE-SK86 1400-72N, 3800-72N, M140015, M380015, PT3810R, M140030, M380030, M140050, T-HD, M380011, M140020, M140023, M140021, M140022, M140038, M380020, M380023, M380021, M380022, M380024, M140060, M380060, M140036, M380035, M380036, M140504, M1405045, M140505, M1405055, M140506, M140507, M140508, M140509, M140510, M140511, M140512, M140513, M140604, M140605, M1406055, M140606, M140607, M140608, M140609, M140610, M140611, M140612, M140613, M380507, M380508, M380509, M380510, M380511, M380512, M380513, M380514, M380515, M380516, M380517, M380518, M380519, M380520, M380521, M380522, M380607, M380608, M380609, M380610, M380611, M380612, M380613, M380614, M380615, M380616, M380617, M380618, M380619, M380620, M380621, M380622, M380040, M380042, M380046.

Contem TTE-SK126 : M1400FRP, 1400B, M140022, M140030, M140060, M140037, M140015, M140504, M1405045, M140505, M1405055, M140506, M140507, M140508, M140509, M140510, M140511, M140512, M140513, M140607, M140608, M140610, M140611, M140613, M1200FRP, 1201, M120021, M120022, M120040, M120042, M120046, M1205106, M1205116, M1205126, M1205136, M1205146, M1205156, M1205166, M1205176, M1205186, M1205196, M1205206, M1205216, M1205246, M1205276, M1205306, M1205326, M1205346, M1206106, M1206136, M1206176, M1206186, M1206196.

Contem TTE-SK63: 1200-72N, M120011, M120050, M120030, M120010, M120020, M120021, M120023, M120024, M120508, M120509, M120510, M120511, M120512, M120513, M120514, M120515, M120516, M120517, M120518, M120519, M120520, M120521, M120522, M120524, M120525, M120526, M120527, M120528, M120529, M120530, M120532, M120534, M120610, M120611, M120612, M120613, M120615, M120616, M120617, M120618, M120619, M120620, M120621, M120622, M120624, M120627, M120630, M120632, M120636, M120040, M120042, M120046.

Contem TTE-SK77: 1400FPR, 3800FPR, 1200FPR, M140015, PT3810R, M140030, M380030, M120030, T-HD, M140022, M140024, M380021, M120022, M380021W, M120021W, M380035, M380036, M120036, M140504, M140505, M1405055, M140506, M140507, M140508, M140509, M140510, M140511, M140512, M140513, M380508, M380509, M380510, M380511, M380512, M380513, M380514, M380515, M380516, M380517, M380518, M380519, M380522, M1205106, M1205116, M1205126, M1205136, M1205146, M1205156, M1205166, M1205176, M1205186, M1205196, M1205226, M140607, M140608, M140610, M140612, M140613, 920513, 920515, 920516, 920517, 920518, 920519, 920522, 920524, 920613, 920615, 920616, 920617, 920618, 920619, 920622, 920624.

Contem TTESK44: M1400-72N, 1200-72N, M140015-C, M140020-C, M120020W-C, M120021W-C, M140023-C, M14050412-C, M140030-C, M120030-C, M14050512-C, M140505512-C, M14050612-C, M14050712-C, M14050812-C, M14050912-C, M14051012-C, M14051112-C, M14051212-C, M14051312-C, M140606-C, M140607-C, M140608-C, M140609-C, M140610-C, M140611-C, M140612-C, M140613-C, M120510-C, M120511-C, M120512-C, M120513-C, M120514-C, M120515-C, M120516-C, M120517-C, M120518-C, M120519-C, M120521-C, M120522-C, M120524-C, M120527-C, M120530-C, M120532-C

Contem TTEAF62: M140106, M140107, M140108, M140109, M140110, M140111, M140112, M140114, M140116, M380112, M380114, M380116, M380118, M380120, M380122, M380124, M120112, M120114, M120116, M120118, M120120, M120122, M120124, M120126, M120128, M120130, M120132, M120136, M120138, M120140, M140206, M140207, M140208, M140209, M140210, M140211, M140212, M140214, M140216, M380212, M380214, M380216, M380218, M380220, M380222, M380224, 600110, 600112, 600114, 600116, 600118, 600120, 600122, 600124, 600126, 600128, 600130, 600132, 600134, 600136, 600140.

Contem TTESK32: M3400-72, M340050S, M340022S, M340070S, M3405196, M3405216, M3405226, M3405246, M3405276, M3405306, M3405326, M3405336, M3405346, M3405366, M3405386, M3405416, M3405466, M3405506, M340128, M340130, M340132, M340136, M340138, M340140, M340142, M340144, M340146, M340148, M340152, M340156, M340160.

Contem TTEISK73: 920030, 980020, 920020, 920021, 920023, 980035, 980036, 980060, 920036, 920037, 920060, 980508, 980510, 980511, 980512, 980513, 980514, 980515, 980516, 980517, 980518, 980519, 980608, 980610, 980611, 980612, 980613, 980614, 980616, 980617, 980619, 920508, 920510, 920511, 920512, 920513, 920514, 920515, 920516, 920517, 920518, 920519, 920520, 920521, 920522, 920523, 920524, 920525, 920526, 920527, 920528, 920529, 920530, 920532, 920610, 920611, 920612, 920613, 920614, 920615, 920616, 920617, 920618, 920619, 920621, 920622, 920624, 920627, 920628, 920629, 920630, 920632, 920635, 920636.

Contem TTEISK33: 940022, 940037, 940085, 940519, 940521, 940522, 940523, 940524, 940527, 940528, 940530, 940532, 940533, 940534, 940536, 940538, 940541, 940546, 940619, 940621, 940622, 940623, 940624, 940627, 940630, 940632, 940632, 940633, 940634, 940636, 940638, 940641, 940646.

Contem TTESK85: M380020, M141404, M1414055, M141601, M141602, M141603, M140704, M140705, M140706, M140707, M140708, M141300, M141301, M141302, M141303, M141210T, M141215T, M141220T, M141225T, M141227T, M141230T, M141240T, M381210T, M381215T, M381220T, M381225T, M381227T, M381230T, M381240T, M381245T, M381250T, M380710, M380712, M380714, M380716, M380718, M381210, M381215, M381220, M381225, M381227, M381230, M381240, M381245, M381250, M381503, M381504, M381505, M381506, M381507, M381508, M381510, M381512, M122220T, M122225T, M122227T, M122230T, M122240T, M122245T, M122250T, M122255T, M122260T, M122505, M122506, M122507, M122508, M122510, M122512, M122805, M122806, M122808, M122810, M122812, M122814, M122816, M122704, M122705, M122706, M122708, M122710, M122711, M122712, M122713.



Tabuleiros EVA - 1000volts

Ch. parafusos	lamina estreita	2.5x3x 4.5x5,5mm
---------------	-----------------	------------------

Contem:	MDV820N, MDV822N, MDV724N, MDV726N
---------	------------------------------------

Ch. parafusos	lamina estreita	pz1, pz2, ph1, ph2
---------------	-----------------	--------------------

Contem:	MDV742N, MDV744N, MDV762N, MDV764N
---------	------------------------------------

Ch. parafusos	lamina estreita	3, 4, 5-5,6-5mm, pz1, pz2, ph1, ph2
---------------	-----------------	-------------------------------------

Ch. dinamometrica	1-5Nm
-------------------	-------

Contem:	1492TVSD, MDV731, MDV732, MDV733, MDV734, MDV751, MDV752, MDV771, MDV772
---------	--

Ch. parafusos	lamina estreita	3, 4, 5-5,6-5mm, pz1, pz2, ph1, ph2
---------------	-----------------	-------------------------------------

Ch. aperto	cabo Se e cabo L
------------	------------------

Contem:	MDV710, MDV700, MDV731, MDV732, MDV733, MDV734, MDV751, MDV752, MDV771, MDV772
---------	--

Ch. parafusos	fendas	2.5x75, 3.5x100, 4x100, 5.5x125mm
---------------	--------	-----------------------------------

PH	PH0, PH1, PH2
----	---------------

PZ	PZ2
----	-----

Busca pólos	100-250 volts
-------------	---------------

Contem:	MDV820N, MDV823N, MDV824N, MDV826N, MDV840N, MDV842N, MDV844N, MDV864N, MDV9855.
---------	--

TEA-MDV04N | € 29,20

Tabuleiro TED 4 peças 1000v.



TEA Sets



TEA-MDV04N1 | € 33,00

Tabuleiro TED 4 peças 1000v.



TEA Sets

TEA-VSD09 | € 130,00

Tabuleiro TED 9 peças, alicates 1000v.



TEA Sets

TEA-MDV10 | € 42,20

Tabuleiro TED 10 peças 1000v.



TEA Sets

TED-V909N | € 67,00

Tabuleiro TED 9 peças 1000v.

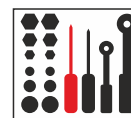

TED Sets



TED-V440 | € 110,00

Tabuleiro TED 4 peças 1000v.

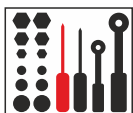

TED Sets



Alicates 6" corte lateral, 8" combinado, 8" pontas longas, 7" descarnador

Contem: MBV441-6, MBV451-8, MBV461-8, MBV499-7.

TED-VMB08 € 129,00

Tabuleiro TED 8 peças 1000v.

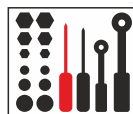

TED Sets



Alicates 8" corte , 10" bomba d'água, 8" pontas longas,

Corte faca e laminas substituição

Contem: MKV709, MKV709A, MBV482-10Q, MBV463-8, MBV444-8

TED-VSP12 | € 218,00

Tabuleiro TED 12 peças 1000v.

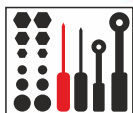

TED Sets



Ch boca isol. 8, 9, 10, 11, 12, 13, 14, 15, 16, 17, 18 e 19mm

Contem:MPV600508, MPV600509, MPV600510, MPV600511, MPV600512, MPV600513, MPV600514, MPV600515, MPV600516, MPV600517, MPV600518, MPV600519

TED-V3818 | € 247,00

Tabuleiro TED 18 peças 1000v.

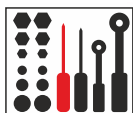

TED Sets



Ch 3/8" isol. 6, 7, 8, 9, 10, 11, 12, 13, 14, 15, 16, 17, 18, 19 e 20mm

extensões 75 e 150mm

roquete 3/8"

Contem: MV3800, MV380020, MV380021, MV380506, MV380507, MV380508, MV380509, MV380510, MV380511, MV380512, MV380513, MV380514, MV380515, MV380516, MV380517, MV380518, MV380519, MV380520



Ch 3/8" isol.	6, 7, 8, 9, 10, 11, 12, 13, 14, 15, 16, 17, 18, 19 e 20mm	
extensões	75 e 150mm	
roquete	3/8"	
Ch. parafusos	lamina estreita	3, 4, 5-5,6-5mm, pz1, pz2, ph1, ph2
Ch. aperto	cabo S e cabo L	

Contem: MV3800, MV380020, MV380021, MV380506, MV380507, MV380508, MV380509, MV380510, MV380511, MV380512, MV380513, MV380514, MV380515, MV380516, MV380517, MV380518, MV380519, MV380520, MDV710, MDV700, MDV731, MDV732, MDV733, MDV734, MDV751, MDV752, MDV771, MDV772

Ch 3/8" isol.	6, 7, 8, 9, 10, 11, 12, 13, 14, 15, 16, 17, 18, 19 e 20mm	
extensões	75 e 150mm	
roquete	3/8"	
Ch. parafusos	lamina estreita	3, 4, 5-5,6-5mm, pz1, pz2, ph1, ph2
Ch. dinamometrica	1-5Nm	

Contem: MV3800, MV380020, MV380021, MV380506, MV380507, MV380508, MV380509, MV380510, MV380511, MV380512, MV380513, MV380514, MV380515, MV380516, MV380517, MV380518, MV380519, MV380520, MDV731, MDV732, MDV733, MDV734, MDV751, MDV752, MDV771, MDV772, 1492TVSD

Ch 3/8" isol.	6, 7, 8, 9, 10, 11, 12, 13, 14, 15, 16, 17, 18, 19 e 20mm	
extensões	75 e 150mm	
roquete	3/8"	
Alicates	I	6" corte lateral, 8" combinado, 8" pontas longas, 7" descarnador

Contem: MV3800, MV380020, MV380021, MV380506, MV380507, MV380508, MV380509, MV380510, MV380511, MV380512, MV380513, MV380514, MV380515, MV380516, MV380517, MV380518, MV380519, MV380520, MBV441-6, MBV451-8, MBV461-8, MBV499.

Ch boca isol.	7, 8, 9, 10, 11, 12, 13, 14, 15, 16, 17, 18, 19, 20, 22, 24mm
---------------	---

Contem: MPV600507, MPV600508, MPV600509, MPV600510, MPV600511, MPV600512, MPV600513, MPV600514, MPV600515, MPV600516, MPV600517, MPV600518, MPV600519, MPV600520, MPV600522, MPV600524.

Ch boca isol.	8, 10, 12, 13, 14, 17, 19mm
Ch fenda isol.	4, 5-5, ph1-ph2-pz2
Ch boca isol.	faca e laminas substituição

Contem: MPV600508, MPV600510, MPV600512, MPV600513, MPV600514, MPV600517, MPV600519, MDV824N, MDV826N, MDV842N, MDV844N, MDV864N, MKV709, MKV709A

TEF-XV28 | € 305,00

Tabuleiro TED 28 peças 1000v.



TTEVA Sets

TEF-XV27 | € 390,00

Tabuleiro TED 27 peças 1000v.



TTEVA Sets

TEF-SKV19 | € 326,00

Tabuleiro TED 19 peças 1000v.

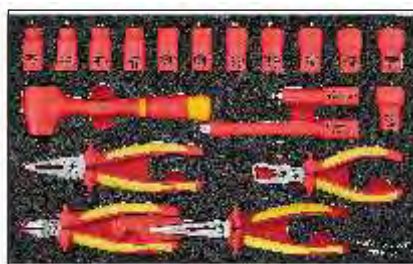

TTEVA Sets

TEF-SPV17 | € 338,00

Tabuleiro TED 17 peças 1000v.



TTEVA Sets

TEF-XV17 € 192,00

Tabuleiro TED 17 peças 1000v.



TTEVA Sets



TEF-XV11 | € 156,00

Tabuleiro TED 11 peças 1000v.

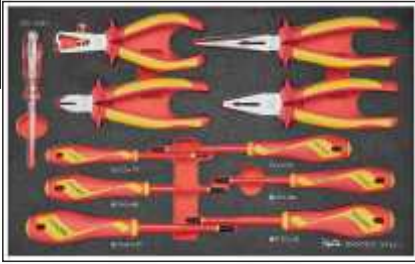

Alicates	6" corte lateral, 8" combinado, 8" pontas longas, 7" descarnador
chaves	2-5, 4, ph1, ph2, pz1, pz2, busca-polos

Contem: MBV441-6MBV451-7MBV461-8MBV499-7, MDV9855, MDV820N, MDV724N, MDV742N, MDV744N, MDV762N, MDV764N

TEF-MBV07 | € 194,00

Tabuleiro TED 7 peças 1000v.

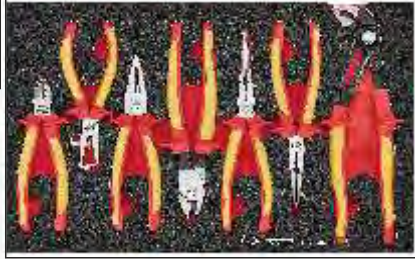

Alicates	6" corte lateral, 8" corte, 7" combinado, 8" pontas longas, 8" pontas longas curvas, 10" bomba d'água, 7" descarnador
----------	---

Contem: MBV441-6, MBV444-8, MBV451-7, MBV461-8, MBV463-8, MBV482-10Q, MBV499-7

TEF-MDV12 | € 92,00

Tabuleiro TED 12 peças 1000v.

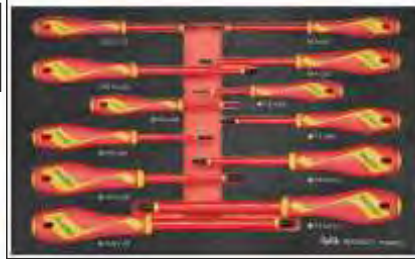

chaves	2-5, 3, 4, 5-5mm, ph0, ph1, ph2, ph3, pz0, pz1, pz2, pz3
--------	--

Contem: MDV820N, MDV822N, MDV724N, MDV726N, MDV840N, MDV742N, MDV744N, MDV846N, MDV860N, MDV762N, MDV764N, MDV866N

TEF-MDV15 | € 97,00

Tabuleiro TED 15 peças 1000v.

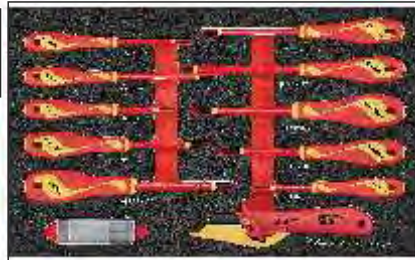

chaves	2-5, 3, 4, 5-5mm, ph0, ph1, ph2, pz0, pz1, pz2
--------	--

corte	faca e laminas de substituição
-------	--------------------------------

Contem: MDV820N, MDV822N, ,MDV824N, MDV826N, MDV840N, MDV842N, MDV844N, MDV860N, MDV862N, MDV864N, MKV709, MKV709A



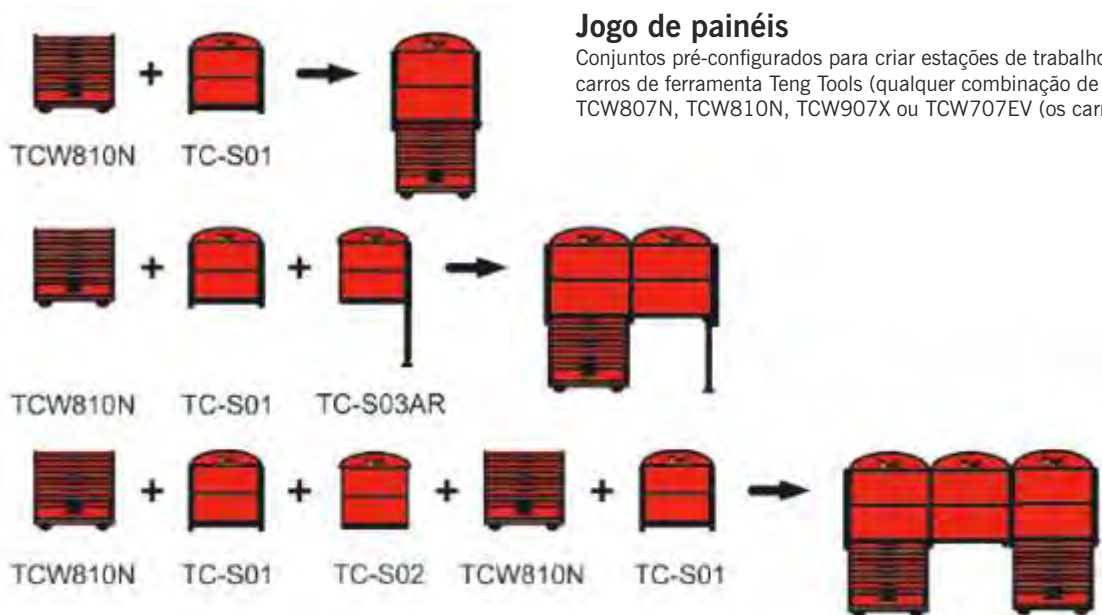

Jogo de painéis

Conjuntos pré-configurados para criar estações de trabalho com base em um ou dois carros de ferramenta Teng Tools (qualquer combinação de TCW806N, TCW806N1, TCW807N, TCW810N, TCW907X ou TCW707EV (os carros não estão incluídos).

nº Stock	Painéis	Barras laterais	Tampos	Travamento	Topo (logótipo)	Suporte de ligação	Pernas	Preço
TC-S01	2 x TC-PA01	1 x TC-UPRR 1 x TC-UPRL	1 x TC-TB02	1 x TC-FB01	1 x TC-H01			€ 375,00
TC-S02	2 x TC-PA01		1 x TC-TB02	1 x TC-FB01	1 x TC-H01	2 x TC-LBK		€ 338,00
TC-S03AR (direito)	2 x TC-PA01	1 x TC-UPRR	1 x TC-TB02	1 x TC-FB01	1 x TC-H01	2 x TC-LBK	1 x TC-LEG	€ 440,00
TC-S03AL (esquerdo)	2 x TC-PA01	1 x TC-UPRL	1 x TC-TB02	1 x TC-FB01	1 x TC-H01	2 x TC-LBK	1 x TC-LEG	€ 440,00

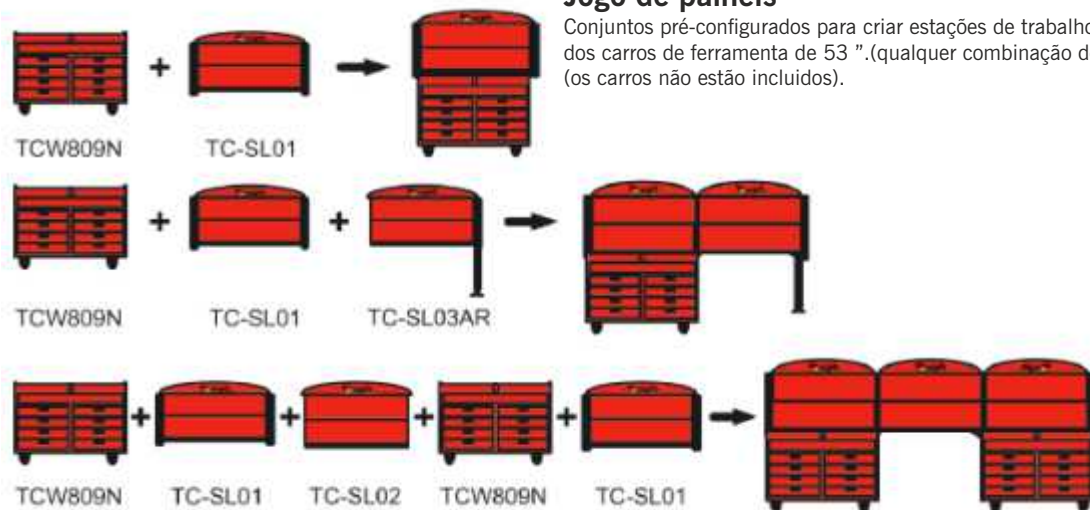

Jogo de painéis

Conjuntos pré-configurados para criar estações de trabalho com base em um ou dois carros de ferramenta de 53 ".(qualquer combinação de TCW806LN ou TCW809N (os carros não estão incluídos).

nº Stock	Painéis	Barras laterais	Tampos	Travamento	Topo (logótipo)	Suporte de ligação	Pernas	Preço
TC-SL01	2 x TC-PA02	1 x TC-UPRR 1 x TC-UPRL		1 x TC-FB02	1 x TC-H02			€ 365,00
TC-SL02	2 x TC-PA02		1 x TC-TB01	1 x TC-FB02	1 x TC-H02	2 x TC-LBK		€ 542,00
TC-SL03AR (direito)	2 x TC-PA02	1 x TC-UPRR	1 x TC-TB01	1 x TC-FB02	1 x TC-H02	2 x TC-LBK	1 x TC-LEG	€ 650,00
TC-SL03AL (esquerdo)	2 x TC-PA02	1 x TC-UPRL	1 x TC-TB01	1 x TC-FB02	1 x TC-H02	2 x TC-LBK	1 x TC-LEG	€ 650,00



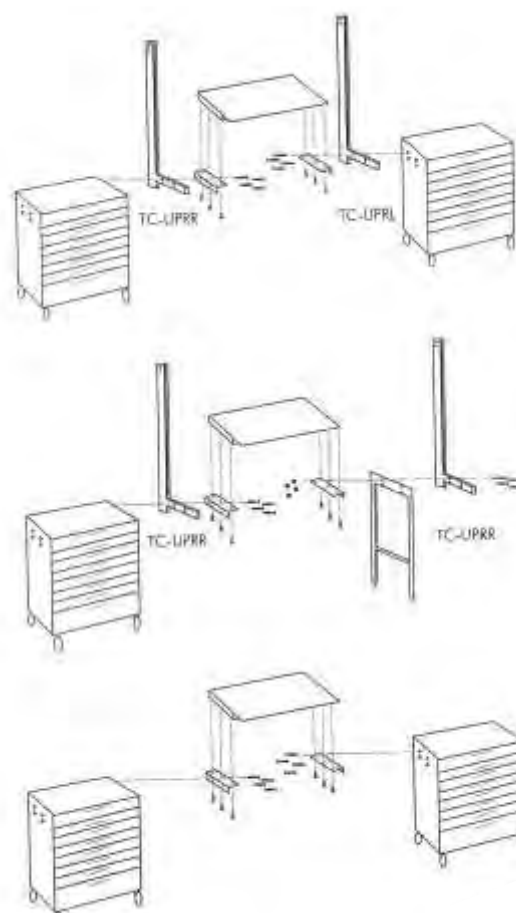
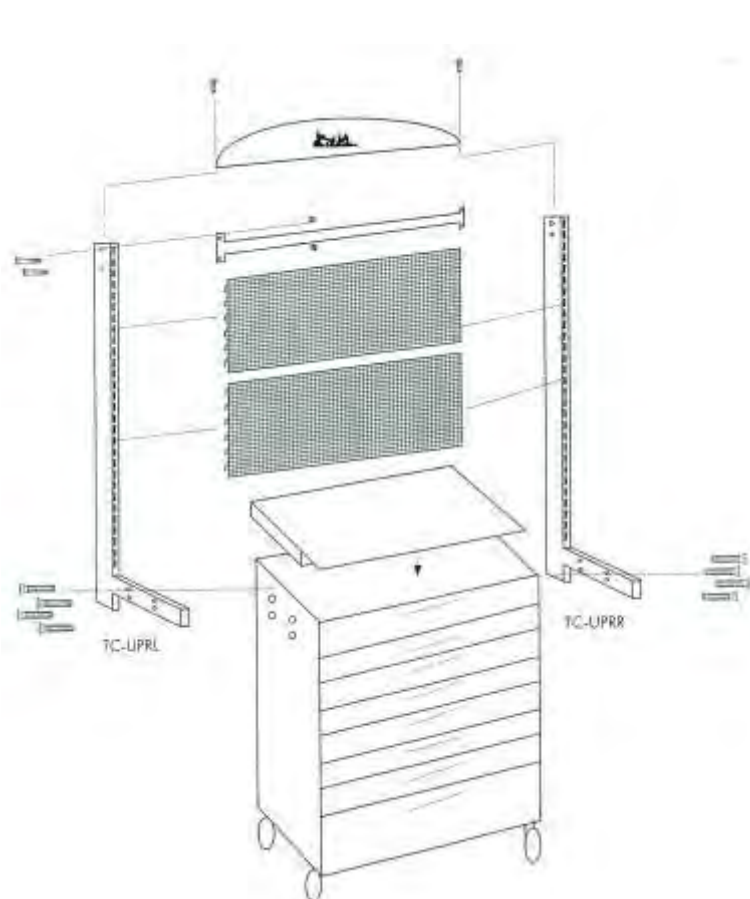

nº Stock	Comp. mm	Prof. mm	Altura mm	Para	Preço
TC-H01	670	25	60	TC-PA01	€ 19,00
TC-H02	1380	25	65	TC-PA02	€ 28,20
TC-H03	950	25	60	TC-PA03	€ 33,00

Topo com logótipo para painéis

Para aplicar em painéis TC-PA01 e TC-PA02.



	Comp. mm	Profundidade mm	Espessura mm	Preço
TC-TB02	672	460	37	€ 113,00
Para: TCW803N, TCW804N, TCW806N, TCW806N1, TCW807N, TCW808N, TCW810N, TCW707EV, TCW907X				
TC-TB01	1354	460	37	€ 216,00
Para: TCW806LN, TCW809N				

Tampos

Para aplicar em carros e prolongamento de bancada.



nº Stock	Comp. mm	Prof. mm	Altura mm	Preço
TC-PA01	665	1.6	480	€ 66,00
TC-PA02	1370	1.6	480	€ 110,00
TC-PA03	920	1.6	480	€ 85,00

Painéis perfurados

Painéis perfurados para aplicar em bancadas e painéis.

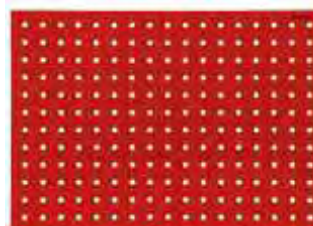

Travamento

Barra transversal, aplicada entre barras verticais de painel.



nº Stock	Comp. mm	Prof. mm	Altura mm	Preço
TC-FB01	664	1.2	30	€ 13,00
TC-FB02	1342	1.2	30	€ 20,00
TC-FB03	916	1.2	30	€ 14,15



Barras laterais para painéis

Barras laterais para aplicar painéis em carros de ferramentas.



nº Stock	barra	Preço
TC-UPRR	direita	€ 46,00
TC-UPRL	esquerda	€ 46,00

nº Stock	barra	Preço
TC-UPRRS	direita (curta)	€ 40,00
TC-UPRLS	esquerda (curta)	€ 40,00

Pernas



nº Stock	Comp. mm	Prof. mm	Altura mm	Preço
TC-LEG	395	40	925	€ 76,00

Suporte adaptador



nº Stock	Comp. mm	Esp. mm	Altura mm	Preço
TC-LBK	300	2	150	€ 36,00

Suportes para painéis perfurados



	Largura (mm)	Profund (mm)	Altura (mm)	Preço
TC-T01	230	101	139	€ 35,00
TC-T02	460	101	140	€ 40,00
TC-T03	640	101	141	€ 47,00

	Largura (mm)	Prof. (mm)	Altura (mm)	nº furos	Preço
TC-C01	230	98	136	2	€ 34,00
TC-C02	460	99	137	4	€ 38,00
TC-C03	640	100	138	6	€ 44,00

	Largura (mm)	Prof. (mm)	Altura (mm)	Preço
TC-T04	23.5	2	178	€ 30,00



587-J | € 59,00

Lâmpada Led 255mm, 9 leds, ângulo de iluminação 120°, fixação magnética, para uso com bancadas, painéis ou carros de ferramenta. Alimentação 3 pilhas AAA (não incluídas). (255 x 40 x 29mm)



Bancadas de Trabalho

Bancadas de trabalho com superfície de trabalho resistente, laminada, com efeito granito e bordas pretas.

Fornecidas com um par de pernas totalmente ajustáveis, proporcionam uma altura de trabalho de entre 707 e 927mm.

nº Stock	Comp. cm	Prof. cm	Altura cm	Preço
TWB-1500	150	80	53	€ 465,00
TWB-2000	200	80	69	€ 565,00



Kit de Painéis

Um kit de painéis com colunas verticais e parafusos de fixação para aplicar na bancada de trabalho (conforme a figura). Cada painel usa um sistema de orifícios quadrados para uso com uma variedade de ganchos e acessórios.

nº Stock	nº de painéis	Preço
TWB-1500A	2	€ 225,00
TWB-2000A	4	€ 410,00

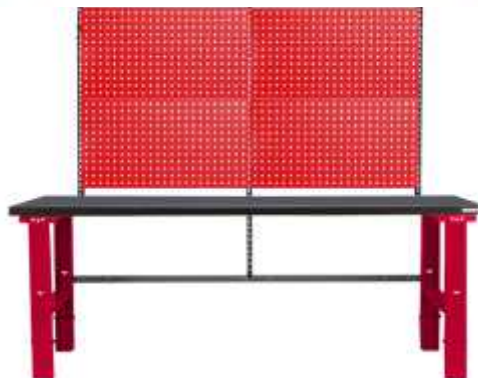

Topos para Bancadas

Em madeira laminada de grande resistência, superfície com efeito granito e bordas pretas.

nº Stock	Comp. cm	Prof. cm	Esp. cm	Preço
TWB-15TOP	150	80	3.7	€ 335,00
TWB-20TOP	200	80	3.7	€ 430,00



TWB-LEG | € 210,00

Par de pernas para bancadas, ajustáveis entre 707 e 927mm.

TWB-PA | € 70,00

Painéis para bancadas de trabalho, 895 x 483mm.

TWB-UPR | € 32,00

Barra vertical para fixar painéis a bancada.

TWB-4WD | € 82,00

Kit 4 rodas pivôs. Capacidade 80kg (x1) ou 250kg (x4).



589-ME | € 107,00

Lâmpada Led 660mm, 80 leds, 2040 lúmen, fixação magnética, para uso com bancadas, painéis ou carros de ferramenta. Alimentação 230v.



Painel para carros de ferramentas

Um conjunto pré-configurado de painéis, barra de fixação, barras verticais e cabeçalho para carros de ferramentas TCW207N



TC-S03



TC-S04

n° Stock	TC-S03	TC-S04
Preço	€ 295,00	€ 216,00
Conteúdo		
Painéis	2 x TC-PA03	1 x TC-PA03
Barras laterais	1 x TC-UPRR 1 x TC-UPRL	1 x TC-UPRRS 1 x TC-UPRLS
Barras fixação	1 x TC-FB03	1 x TC-FB03
Topo (logótipo)	1 x TC-H05	



Contem: TPM01, WRMD910N, WRMB04, WRSP12, WRHEX07.

n° Stock	TP-M01 (vazio)	TP-M02 (vazio)	TP-T01 (c/ ferramentas)
Preço	€ 360,00	€ 450,00	€ 625,00
Conteúdo			
Painéis	2 x TC-PA01	4 x TC-PA01	2 x TC-PA01
Barras laterais	1 x TC-160UR	1 x TC-160UR	1 x TC-160UR
Barras fixação	2 x TC-FB01	2 x TC-FB01	2 x TC-FB01
Topo (logótipo)	1 x TC-H01	1 x TC-H01	1 x TC-H01



Ganchos para Painéis de Ferramenta



	Ganchos	Preço
TCW-HK10	7 x 90°, 3 x 45° simples	€ 13,50
TCW-HK02	10 duplos	€ 15,50
TCW-HK03	4 x 45° simples, 4 x 45° duplos, 4 x 90° simples, 4 clip pequeno e 4 clip grande clips	€ 23,00
TCW-HK20	6 x 90°, 6 x 45° duplos	€ 27,00
TCW-HK45	10 x 45° simples	€ 14,00
TCW-HK90	10 x 90° simples	€ 13,00
TCW-HKAIR	10 ganchos para ferramenta AR	€ 10,00
TCW-HKB	10 ganchos clip grande	€ 15,00



TCB-80 | € 300,00

Armário de ferramentas de parede, com fechadura de combinação. Os painéis têm orifícios quadrados, o mesmo sistema utilizado nos painéis de bancada.

Largura (mm)	Profundidade (mm)	Altura (mm)	Peso (kg)
660	600	305	15

**TCB-80A | € 355,00**

Armário de ferramentas de parede, com fechadura de combinação. Os painéis têm orifícios quadrados, o mesmo sistema utilizado nos painéis de bancada.

Largura (mm)	Profundidade (mm)	Altura (mm)	Peso (kg)
660	600	455	16.5

**TCB-80C | € 410,00**

Armário de ferramentas de parede, com fechadura de combinação.

Largura (mm)	Profundidade (mm)	Altura (mm)	Peso (kg)
820	250	900	24

**TCB-135 | € 740,00**

Armário de ferramentas de parede, com persiana frontal, fechadura de combinação. O painel interno possui orifícios quadrados, o mesmo sistema que os painéis da bancada.

Largura (mm)	Profundidade (mm)	Altura (mm)	Peso (kg)
1335	200	700	36

**TCB-180 | € 965,00**

Armário de ferramentas de parede, com persiana frontal, fechadura de combinação. O painel interno possui orifícios quadrados, o mesmo sistema que os painéis da bancada.

Largura (mm)	Profundidade (mm)	Altura (mm)	Peso (kg)
1800	200	700	50



WR-8012 | € 88,00

Jogo de suporte para painéis com 12 chaves boca/luneta anti-deslizantes.



Chaves boca/luneta 8, 9, 10, 11, 12, 13, 14, 15, 16, 17, 18, 19mm

Contem: 800608, 800609, 800610, 800611, 800612, 800613, 800614, 800615, 800616, 800617, 800618, 800619.

WR-SP12 | € 67,00

Jogo de suporte para painéis com 12 chaves boca/luneta.



Chaves boca/luneta 8, 9, 10, 11, 12, 13, 14, 15, 16, 17, 18, 19mm

Contem: 600508, 600509, 600510, 600511, 600512, 600513, 600514, 600515, 600516, 600517, 600518, 600519.

WR-SP12LMP | € 85,00

Jogo de suporte para painéis com 12 chaves longas boca/luneta.



Chaves boca/luneta 8, 9, 10, 11, 12, 13, 14, 15, 16, 17, 18, 19mm

Contem: 605908, 605909, 605910, 605911, 605912, 605913, 605914, 605915, 605916, 605917, 605918, 605919.

WR-SP12RS | € 210,00

Jogo de suporte para painéis com 12 chaves



Chaves boca/luneta 8, 9, 10, 11, 12, 13, 14, 15, 16, 17, 18, 19mm

Contem: 600508RS, 600509RS, 600510RS, 600511RS, 600512RS, 600513RS, 600514RS, 600515RS, 600516RS, 600517RS, 600518RS, 600519RS.

WR-DF06 | € 109,00

Jogo de suporte para painéis com 6 chaves flexíveis.



Chaves flexíveis 8x9, 10x11, 12x13, 14x15, 16x17, 18x19mm

Contem: 650809, 651011, 651213, 651415, 651617, 651819.



Chaves luneta	8x10, 11x13, 12x14, 17x19, 22x24mm
---------------	------------------------------------

Contem:	630810FL, 631113FL, 631214FL, 631719FL, 632224FL.
---------	---

WR-FLS05 | € 162,00

Jogo de suporte para painéis com 6 chaves luneta extra-longas.



Chaves T hex.	2.5, 3, 4, 5, 6, 7, 8mm
---------------	-------------------------

Contem:	5105025, 510503, 510504, 510505, 510506, 510507, 510508.
---------	--

WR-HEX07 | € 50,00

Jogo de suporte para painéis com 7 chaves T hexagonais.



Chaves T hex.	3/32", 1/8", 5/32", 3/16", 7/32", 1/4", 5/16"
---------------	---

Contem:	510103, 510104, 510105, 510106, 510107, 510108, 510110.
---------	---

WR-HEX07AF | € 52,00

Jogo de suporte para painéis com 7 chaves T hexagonais.



Chaves T tx	tx10, tx15, tx20, tx25, tx27, tx30, tx40
-------------	--

Contem:	5105025, 510503, 510504, 510505, 510506, 510507, 510508.
---------	--

WR-TX07 | € 42,00

Jogo de suporte para painéis com 7 chaves T torx.



Chaves de parafusos	fendas	0.5x3.0x100, 1.0x5.5x75, 1.0x5.5x150, 1.2x6.5x150, 1.2x8.0x150mm
---------------------	--------	--

PH	PH0x75, PH1x75, PH2x100mm
----	---------------------------

PZ	PZ1x75, PZ2x100mm
----	-------------------

Contem:	MD920N1, MD922N, MD923N, MD928N2, MD934N, MD940N, MD947N1, MD948N1, MD961N, MD962N.
---------	---

WR-MD10N | € 62,00

Jogo de suporte para painéis com 10 chaves de parafusos, PH, PZ e fendas.



WR-MDT05N | € 50,00

Jogo de suporte para painéis com 5 chaves de parafusos impacto.



Chaves de parafusos	fendas	1.2x6.5x100, 1.2x8.0x150, 1.6x10x200mm
	PH	PH2x100, PH3x150mm

Contem: MDT932N, MDT934N, MDT935N, MDT952N, MDT953N.

WR-MB04 | € 87,00

Jogo de suporte para painéis com 4 alicates.



Alicates	6" corte lateral, 7" universal, 8" pontas longas, 10" bomba de água
----------	---

Contem: MB441-6T, MB452-7T, MB461-8T, MB481-10T.

WR-WC07 | € 71,00

Jogo de suporte para painéis com 7 formões.



Formões	6, 10, 12, 16, 18, 20 e 25mm
---------	------------------------------

Contem: WCC06, WCC10, WCC12, WCC16, WCC20, WCC25.

WR-FL05 | € 50,00

Jogo de suporte para painéis com 5 limas 10".



Limas 10"	plana, murça, meia-cana, redonda, triangular
-----------	--

Contem: FLFT10, FLHF10, FLHR10, FLRD10, FLTR10.

WR-PC10 | € 77,00

Jogo de suporte para painéis com 10 peças de ferramenta de pancada.



Punções	3, 4, 5, 6, 7, 7, 8mm
---------	-----------------------

Cinzeis	19x150, 25x200, 25x250mm
---------	--------------------------

Punção de bico	5x150mm
----------------	---------

Contem: CP05, PP03, PP04, PP05, PP06, PP07, PP08, CC150F, CC200F, CC250F.



Alicates 1000v 6" corte lateral, 7" universal, 8" pontas longas, 8" corte lateral

Contem: MBV441-6, MBV442-8, MBV451-7, MBV461-8.

WR-MBV04 | € 74,00

Jogo de suporte para painéis com 4 alicates 1000v.

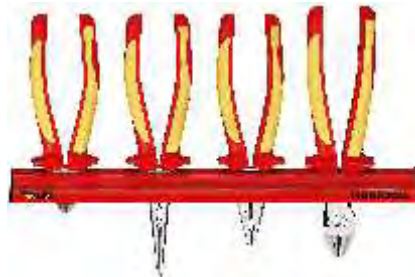

Chaves de parafusos fendas 0.5x3.0x100, 1.0x5.5x125mm

PH PH1x80, PH2x100mm

PZ Pz2x100mm

Contem: MDV822N, MDV826N, MDV840N, MDV842N, MDV862N.

WR-MDV05N | € 37,00

Jogo de suporte para painéis com 5 chaves de parafusos 1000v.



Chaves de parafusos fendas 0.4.x2.5x75, 0.5x3.0x100, 0.8x4.0x100, 1.0x5.5x125mm

PH PH1x80, PH2x100mm

Busca polos 100 a 250 volts

Contem: MDV820N, MDV822N, MDV824N, MDV826N, MDV842N, MDV862N, MDV9855.

WR-MDV07N | € 43,00

Jogo de suporte para painéis com 6 chaves de parafusos 1000v e busca polos.



Jogos de 1/4"

TJ-1415 | € 46,00

Jogo bolso 1/4" 15pcs



TJ-1419 | € 39,00

Jogo bolso 1/4" 19pcs



TJ-1420 | € 40,00

Jogo bolso 1/4" 20pcs



Contém: 1400-72SN, M140020, M140030, M140555, M140506, M140507, M140508, M140510, M140511, M140513, bits

Contém: 1400-B, M140037, ACC50MBH01, M140508, M140509, M140510, M140511, M140512, M140513, bits

Contém: 1400-B, M140037, ACC50MBH01, M1405055, M140506, M140507, M140508, M140509, M140510, M140513, bits



T-1408 | € 40,00

Jogo 1/4" com 7 chaves de caixa sextavadas e roquete reversível 72 dentes.



Contém: 1400-72MN,, M1405055, M140506, M140507, M140508, M140510, M140512, M140513.

T-1419 | € 40,00

Jogo 1/4" com 6 chaves de caixa sextavadas, roquete para bits, adaptador magnético e 11 bits.



Contém: 1400B, ACC50MBH01, M140508, M140509, M140510, M140511, M140512, M140513, Bits.

T-1420 | € 41,00

Jogo 1/4" com 7 chaves de caixa sextavadas, roquete para bits, adaptador magnético e 11 bits.



Contém: 1400B, ACC50MBH01, M1405055, M140506, M140507, M140508, M140509, M140510, M140513, Bits.

T-1423 | € 54,00

Jogo 1/4" com 9 chaves de caixa sextavadas, roquete para bits, adaptador, extensão 2", 10 bits e chave crescente.



Contém: 1400B, ACC50MBH01, M140020, 4001, M140504, M140505, M1405055, M140506, M140507, M140508, M140510, M140512, M140513, Bits.



Acessórios	1/4"		roquete reversível 72 dentes, adaptador para bits, extensão 2"
Chaves de caixa	1/4"	6 pontos	4, 5, 5.5, 6, 7, 8, 10, 12, 13mm
Bits	1/4"	hex	TX10, TX15, TX20, fendas 4, 5.5, 6.5mm, PH1, PH2, PZ1, PZ2

Contém: 1400-72N, M140060, M140020, M140504, M140505, M1405055, M140506, M140507, M140508, M140509, M140510, M140511, M140512, M140513.

Acessórios	1/4"		roquete FRP, extensão 3", junta universal, adaptador para bits
Chaves de caixa	1/4"	6 pontos	4, 5, 5.5, 6, 7, 8, 10, 11, 12, 13mm
Bits	1/4"	hex	PH1, PH2, hex. 3, 5, 6mm, TX10, TX15, TX20, fendas 4, 5.5mm

Contém: 1400FRP, M140023, M140030, M140504, M140505, M1405055, M140506, M140507, M140508, M140510, M140511, M140512, M140513, Bits.

Acessórios	1/4"		roquete reversível articulado, extensão 3", junta universal, adaptador para bits
Chaves de caixa	1/4"	6 pontos	4, 5, 5.5, 6, 7, 8, 10, 11, 12, 13mm
Bits	1/4"	hex	PH1, PH2, hex. 3, 5, 6mm, TX10, TX15, TX20, fendas 4, 5.5mm

Contém: 1400-72SN, M140060, M140023, M140030, M140504, M140505, M1405055, M140506, M140507, M140508, M140510, M140511, M140512, M140513.

Acessórios	1/4"		roquete FRP, extensões 2" e 4", junta universal, adaptador para bits, adaptador F3/8":M1/4", ch. umbrako 1.5, 2, 2.5mm
Chaves de caixa	1/4"	6 pontos	3/16", 7/32", 1/4", 9/32", 5/16", 11/32", 3/8", 7/16", 1/2"
Ch. cx. longas	1/4"	6 pontos	3/16", 1/4", 5/16", 3/8", 7/16", 1/2"
Bits	1/4"	hex	TX10, TX15, TX20, hex. 5, 6mm, PH1, PH2, PZ1, PZ2, fendas 4, 5.5mm

Contém: 1400FRP, M140060, M380035, M140020, M140021, M140030, 3105015, 310502, 3105025, M140106, M140107, M140108, M140109, M140110, M140111, M140112, M140114, M140116, M140206, M140208, M140210, M140212, M140214, M140216, Bits.

T-1422 | € 57,00

Jogo 1/4" com 9 chaves de caixa sextavadas, roquete reversível 72 dentes, adaptador para bits, extensão 2" e 10 bits.

**T-1424 | € 44,00**

Jogo 1/4" com 10 chaves de caixa sextavadas, roquete FRP, junta universal, extensão 3", adaptador para bits e 10 bits.

**T-1424S | € 55,00**

Jogo 1/4" com 10 chaves de caixa sextavadas, roquete reversível articulado 72 dentes, junta universal, extensão 3",

**T-1435AF | € 63,00**

Jogo 1/4" com 15 chaves de caixa sextavadas, roquete FRP, junta universal, duas extensões, adaptador para bits, adaptador F3/8":M1/4", 3 chaves umbrako e 11 bits.



T-1436 | € 59,00

Jogo 1/4" com 16 chaves de caixa sextavadas, roquete FRP, junta universal, duas extensões, adaptador para bits, adaptador F3/8":M1/4", 3 chaves umbrako e 11 bits.



Acessórios	1/4"		roquete FRP, extensões 2" e 4", junta universal, adaptador para bits, adaptador F3/8":M1/4", ch. umbrako 1.5, 2, 2.5mm
Chaves de caixa	1/4"	6 pontos	4, 5, 5.5, 6, 7, 8, 10, 11, 12, 13mm
Ch. cx. longas	1/4"	6 pontos	6, 7, 8, 10, 12, 13mm
Bits	1/4"	hex	TX10, TX15, TX20, hex. 5, 6mm, PH1, PH2, PZ1, PZ2, fendas 4, 5.5mm

Contém: 1400FRP, M140060, M380035, M140020, M140021, M140030, 3105015, 310502, 3105025, M140504, M140505, M1405055, M140506, M140507, M140508, M140510, M140511, M140512, M140513, M140606, M140607, M140608, M140610, M140612, M140613, Bits.

T-1460 | € 133,00

Jogo 1/4" com 32 chaves de caixa sextavadas, roquete FRP, junta universal, duas extensões, adaptador para bits, barra T, chave de bits e 21 bits.



Acessórios	1/4"		roquete FRP, extensões 2" e 4", junta universal, adaptador para bits, barra T, chave de bits
Chaves de caixa	1/4"	6 pontos	4, 4.5, 5, 5.5, 6, 7, 8, 9, 10, 11, 12, 13mm 3/16", 7/32", 1/4", 9/32", 5/16", 11/32", 3/8", 7/16", 1/2"
Ch. cx. longas	1/4"	6 pontos	6, 7, 8, 10, 12, 13mm 1/4", 5/16", 3/8", 7/16", 1/2"
Bits caixa	1/4"		TX10, TX15, TX20, TX25, TX27, hex. 5, 6mm, PH1, PH2, PZ1, PZ2, fendas 4, 5.5, 7mm
Bits	1/4"	hex	fendas 4, 5.5mm, hex. 5, 6mm, PH1, PH2, PZ1, PZ2

Contém: 1400FRP, M140060, M140015, M140020, M140021, M140030, M140050, M140504, M1405045, M140505, M1405055, M140506, M140507, M140508, M140509, M140510, M140511, M140512, M140513, M140106, M140107, M140108, M140109, M140110, M140111, M140112, M140114, M140116, M140606, M140607, M140608, M140610, M140612, M140613, M140208, M140210, M140212, M140214, M140216, Bits.

M-1413N1 | € 44,00

Jogo 1/4" com 11 chaves de caixa sextavadas, extensão 2" e roquete FRP.



Acessórios	1/4"		roquete FRP, extensão 2"
Chaves de caixa	1/4"	6 pontos	4, 5, 5.5, 6, 7, 8, 9, 10, 11, 12, 13mm

Contém: 1400FRP, M140020, M140504, M140505, M1405055, M140506, M140507, M140508, M140509, M140510, M140511, M140512, M140513.

M-1412 | € 12,50

Jogo 12 chaves de caixa sextavadas 1/4", fornecido em carril com clips.



Acessórios			carril 185mm, 12 clips para chaves 1/4"
Chaves de caixa	1/4"	6 pontos	4, 4.5, 5, 5.5, 6, 7, 8, 9, 10, 11, 12, 13mm

Contém: M140504, M1405045, M140505, M1405055, M140506, M140507, M140508, M140509, M140510, M140511, M140512, M140513.

M-1408TX | € 17,00

Jogo 7 chaves de caixa TX 1/4", fornecido em carril com clips.



Acessórios			carril 110mm, 7 clips para chaves 1/4"
Bits de caixa	1/4"	TX	TX10, TX15, TX20, TX25, TX27, TX30, TX40

Contém: M141210T, M140215T, M140220T, M140225T, M140227T, M140230T, M140240T.



Acessórios	carril 185mm, 9 clips para chaves 1/4"		
Ch. cx. longas	1/4"	6 pontos	4, 5, 6, 7, 8, 9, 10, 12, 13mm
Contém: M140604, M140605, M140606, M140607, M140608, M140609, M140610, M140612, M140613.			

Acessórios	carril 185mm, 9 clips para chaves 1/4"		
Ch. cx. HEX	1/4"		3, 4, 5, 5-5, 6, 7, 8, 10, 12mm
Contém: M141503-C, M141504-C, M141505-C, M1415055-C, M141506-C, M141507-C, M141508-C, M141510-C, M141512-C			

M-1407 | € 18,00

Jogo 9 chaves de caixa longas sextavadas 1/4", fornecido em carril com clips.

**M-1409HN | € 18,00**

Jogo 9 chaves de caixa HEX 1/4", fornecido em carril com clips.

**Jogos de 3/8"**

Chaves longas 3/8"	7, 8, 10, 12, 13, 14, 17, 19mm		
Acessórios	T-HD, T-HD01		
Contém: TBSKT07, TBSKT08, TBSKT010, TBSKT12, TBSKT13, TBSKT14, TBSKT17, TBSKT19, THD, THD01			

TBW10 | € 118,00

Jogo 10 chaves longas com quadra de 3/8". Inclui barra T e adaptador T tipo punho. Fornecido em estojo.



Acessórios	3/8"	roquete FRP, extensões 3" e 6", adaptador F1/2":M3/8", adaptador para bits	
Chaves de caixa	3/8"	6 pontos	8, 10, 11, 12, 13, 14, 15, 17, 19mm
Bits 25mm	1/4"	hex	fendas 3, 4, 5.5mm, hex. 3, 4, 5, 6mm, TX10, TX15, TX20, TX25, TX27, TX30, TX40, PH1, PH2, PH3, PZ1, PZ2, PZ3

Contém: 3800FRP, M380020, M380021, M380036, M380060, M380508, M380510, M380511, M380512, M380513, M380514, M380515, M380517, M380519.

T-3834 | € 64,00

Jogo 34 peças, chaves de caixa sextavadas 3/8", roquete FRP e acessórios.



Acessórios	3/8"	roquete flexível 72 dentes, extensões 3" e 6", adaptador F1/4":M3/8", adaptador para bits	
Chaves de caixa	3/8"	6 pontos	8, 10, 11, 12, 13, 14, 15, 17, 19mm
Bits 25mm	1/4"	hex	fendas 3, 4, 5.5mm, hex. 3, 4, 5, 6mm, TX10, TX15, TX20, TX25, TX27, TX30, TX40, PH1, PH2, PH3, PZ1, PZ2, PZ3

Contém: 3800-72SN, M380020, M380021, M140036, M380060, M380030, M380508, M380510, M380511, M380512, M380513, M380514, M380515, M380517, 380519.

T-3834S | € 69,00

Jogo 34 peças, chaves de caixa sextavadas 3/8", roquete flexível 72 dentes e acessórios.



T-3835AF | € 114,00

Jogo 35 peças, chaves de caixa sextavadas 3/8", chaves de velas, roquete FRP e acessórios .



Acessórios	3/8"		roquete FRP, extensões 4" e 6", adaptador F1/2":M3/8", adaptador para bits, junta universal
Chaves de caixa	3/8"	6 pontos	5/16", 3/8", 7/16", 1/2", 9/16", 5/8", 11/16", 3/4", 13/16", 7/8"
Ch. cx. longas	3/8"	6 pontos	3/8", 7/16", 1/2", 9/16", 11/16", 3/4
Chaves de velas	3/8"	6 pontos	16 e 21mm
Bits	1/4"	hex	TX10, TX15, TX20, hex. 5, 6mm, PH1, PH2, PZ1, PZ2, fendas 4, 5.5mm

Contém: 3800FRP, M120036, M380020, M380021, M380030, M380040, M380046, M380060, M380110, M380112, M380114, M380116, M380118, M380120, M380122, M380124, M380126, M380128, M380212, M380214, M380216, M380218, M380222, M380224, Bits.

T-3839 | € 106,00

Jogo 39 peças, chaves de caixa sextavadas 3/8", roquete FRP e acessórios .



Acessórios	3/8"		roquete FRP, extensão flexível 3", extensão 6", adaptador F1/2":M3/8", adaptador para bits, junta universal
Chaves de caixa	3/8"	6 pontos	8, 9, 10, 11, 12, 13, 14, 15, 16, 17, 18, 19, 21, 22mm
Ch. cx. longas	3/8"	6 pontos	8, 10, 12, 13, 17, 19mm
Chaves de velas	3/8"	6 pontos	16 e 21mm
Bits	1/4"	hex	TX10, TX15, TX20, hex. 5, 6mm, PH1, PH2, PZ1, PZ2, fendas 4, 5.5mm

Contém: 3800FRP, M120036, M380020W, M380021, M380030, M380040, M380046, M380060, M380508, M380509, M380510, M380511, M380512, M380513, M380514, M380515, M380516, M380517, M380518, M380519, M380521, M380522, M380608, M380610, M380612, M380613, M380617, M380619, Bits.

T-3840 | € 140,00

Jogo 40 peças, chaves de caixa sextavadas 3/8", chaves boca/luneta, roquete FRP e acessórios .



Acessórios	3/8"		roquete FRP, extensão 6", adaptador F1/2":M3/8", adaptador para bits, junta universal
Chaves de caixa	3/8"	6 pontos	8, 9, 10, 11, 12, 13, 14, 15, 16, 17, 18, 19, 21, 22mm
Ch. boca/luneta			8, 10, 11, 12, 13, 14, 15, 17, 19mm
Bits	1/4"	hex	TX10, TX15, TX20, hex. 5, 6mm, PH1, PH2, PZ1, PZ2, fendas 4, 5.5mm

Contém: 3800FRP, M120036, M380021, M380030, M380040, M380060, M380508, M380509, M380510, M380511, M380512, M380513, M380514, M380515, M380516, M380517, M380518, M380519, M380521, M380522, 600508, 600510, 600511, 600512, 600513, 600514, 600515, 60017, 600519, Bits.

T-3848 | € 339,00

Jogo 48 peças, chaves de caixa sextavadas 3/8", roquete FRP e acessórios .



Acessórios	3/8"		roquete FRP, extensões 3" e 6", adaptador F1/2":M3/8", adaptador para bits, junta universal, chaves de velas 16 e 21mm, chave crescente 8"
Chaves de caixa	3/8"	6 pontos	7/16", 1/2", 9/16", 11/16"
	3/8"	6 pontos	8, 10, 12, 13, 14, 15, 16, 17, 18, 19, 21mm
Ch. boca/luneta			7/16", 1/2", 9/16", 11/16"
			8, 10, 12, 13, 14, 15, 16, 17, 18, 19mm
Ch. parafusos			fendas 3, 5.5, 6.5mm, PH0, PH1, PH2
Alicates			corte lateral 6", universal 8", pontas 8", bomba de água 10", fixação 7"

Contém: 3800FRP, 4003, M120036, M380020, M380021, M380030, M380040, M380046, M380060, M380114, M380116, M380118, M380122, M380508, M380510, M380512, M380513, M380514, M380515, M380516, M380517, M380518, M380519, 600114, 600116, 600118, 600122, 600508, 600510, 600512, 600513, 600514, 600515, 600516, 600517, 600518, 600519, MD920, MD922, MD932, MD940, MD941, MD952, MB441-6T, MB452-7T, MB461-8T, MB481-10T, 401-7.



Acessórios	3/8"	roquete FRP, extensões 3" e 6", adaptador F1/2":M3/8", adaptador para bits, chave de bits magnética
Chaves de caixa	3/8" 6 pontos	8, 9, 10, 11, 12, 13, 14, 15, 16, 17, 18, 19, 20, 22mm
Ch. boca/luneta		8, 10, 11, 12, 13, 14, 15, 16, 17, 19mm
Ch. parafusos		fendas 3, 5.5, 6.5mm, PH0, PH1, PH2
Alicates		cutor lateral 6", universal 8", pontas 8", bomba de água 10"
Bits	1/4" hex	TX8, TX10, TX15, TX20, TX25, TX27, TX30, TX40, TX45, TX50, hex. 3, 4, 5, 6, 8, 10mm, PH0, PH1, PH2, PH3, PZ1, PZ2, PZ3, fendas 4, 5.5, 7mm

Contém: 3800FRP, M380020, M380021, M380030, M380060, M120036, M380508, M380509, M380510, M380511, M380512, M380513, M380514, M380515, M380516, M380517, M380518, M380519, M380520, M380522, 600508, 600510, 600511, 600512, 600513, 600514, 600515, 600516, 600517, 600519, MD900, MD920, MD922, MD932, MD940, MD941, MD952, MB441-6, MB452-7, MB461-8, MB481-10.

Acessórios	3/8"	roquete FRP, extensão 5", junta universal, adaptador F1/2":M3/8", chave de bits magnética, adaptador para bits, lanterna LED, fita métrica 5m, x-acto, apanhador telescópico magnético, jogo 4 peças de gancho e furador, serra manual, martelo carpinteiro 16oz, jogo chaves umbrako 1.5-6mm, chave crescente 8"
Chaves de caixa	3/8" 6 pontos	8, 10, 11, 12, 13, 14, 15, 17, 19, 20, 21, 22mm
Ch. boca/luneta		6, 7, 8, 10, 11mm
Ch. parafusos		fendas 3, 5.5, 6.6mm, PH1, PH2,
Alicates		cutor lateral 6", universal 7", pontas 6", bomba de água 7"
Bits	1/4" hex	TX10, TX15, TX20, TX25, TX27, TX30, TX40, TPX20, TPX25, TPX30, hex. 4, 5, 6mm, PH1, PH2, PH3, PZ1, PZ2, PZ3, fendas 4.5, 5.5, 6.5mm, ROB no1, ROB no2, ROB no3, GR no2(x2)

Contém: 1476NMM, 3800FRP, 4003WT, 581TMP, 584, M120036, M140037, M380060, M380023, M380030, 703, 710, TM149, HMCH16A, M380508, M380510, M380511, M380512, M380513, M380514, M380515, M380517, M380519, M380520, M380521, M380522, 600506, 600507, 600508, 600510, 600511, MD920N, MD922N, MD947N1, MD948N1, MB441-6, MB451-7, MB461-6, MB481-7, MD920N, MD922N, MD947N1, MD948N1, MT05MM, Bits.

Acessórios	3/8"	roquete FRP, extensão 5", junta universal, adaptador F1/2":M3/8", chave de bits magnética, adaptador para bits, lanterna LED, fita métrica 5m, x-acto, apanhador telescópico magnético, jogo 4 peças de gancho e furador, serra manual, martelo engenheiro 500g, jogo chaves umbrako 1.5-6mm, chave crescente 8"
Chaves de caixa	3/8" 6 pontos	8, 10, 11, 12, 13, 14, 15, 17, 19, 20, 21, 22mm
Ch. boca/luneta		6, 7, 8, 10, 11mm
Ch. parafusos		fendas 3, 5.5, 6.6mm, PH1, PH2,
Alicates		cutor lateral 6", universal 7", pontas 6", bomba de água 7"
Bits	1/4" hex	TX10, TX15, TX20, TX25, TX27, TX30, TX40, TPX20, TPX25, TPX30, hex. 4, 5, 6mm, PH1, PH2, PH3, PZ1, PZ2, PZ3, fendas 4.5, 5.5, 6.5mm, ROB no1, ROB no2, ROB no3, GR no2(x2)

Contém: 1476NMM, 3800FRP, 4003WT, 581TMP, 584, M120036, M140037, M380060, M380023, M380030, 703, 710, TM149, HMCH16A, M380508, M380510, M380511, M380512, M380513, M380514, M380515, M380517, M380519, M380520, M380521, M380522, 600506, 600507, 600508, 600510, 600511, MD920N, MD922N, MD947N1, MD948N1, MB441-6, MB451-7, MB461-6, MB481-7, MD920N, MD922N, MD947N1, MD948N1, MT05MM, Bits.

T-3867 | € 290,00

Jogo 67 peças, chaves de caixa sextavadas 3/8", roquete FRP e acessórios .

**TM-079 | € 315,00**

Jogo 79 peças, chaves de caixa sextavadas 3/8", roquete FRP e acessórios .

**TM-079E | € 315,00**

Jogo 79 peças, chaves de caixa sextavadas 3/8", roquete FRP e acessórios .



M-3812N1 | € 50,00

Jogo 10 chaves de caixa sextavadas 3/8", roquete FRP e acessórios.



Acessórios	3/8"	roquete FRP, extensão 3"
Chaves de caixa	3/8"	8, 10, 11, 12, 13, 14, 15, 16, 17, 19mm

Contém: 3800FRP, M380020, M380508, M380510, M380511, M380512, M380513, M380514, M380515, M380516, M380517, M380519.



M-3816 | € 33,00

Jogo 16 chaves de caixa sextavadas 3/8", fornecido em carril com clips.



Acessórios	carril 370mm, 16 clips para chaves 3/8"		
Chaves de caixa	3/8"	6 pontos	7, 8, 9, 10, 11, 12, 13, 14, 15, 16, 17, 18, 19, 20, 21, 22mm

Contém: M380507, M380508, M380509, M380510, M380511, M380512, M380513, M380514, M380515, M380516, M380517, M380518, M380519, M380520, M380521, M380522.

M-3807 | € 22,50

Jogo 7 chaves de caixa longas sextavadas 3/8", fornecido em carril com clips.



Acessórios	carril 165mm, 7 clips para chaves 3/8"		
Ch. cx. longas	3/8"	6 pontos	10, 12, 13, 14, 15, 17, 19mm

Contém: M380610, M380612, M380613, M380614, M380615, M380617, M380619.

M-3811 | € 30,00

Jogo 8 bits de caixa hexagonais 3/8", fornecido em carril com clips.



Acessórios	carril 165mm, 8 clips para chaves 3/8"		
Bits de caixa	3/8"	hex.	3/32", 1/8", 5/32", 3/16", 7/32", 1/4", 5/16", 3/8"

Contém: M381103, M381104, M381105, M381106, M381107, M381108, M381110, M381112.

M-3812 | € 30,00

Jogo 9 bits de caixa hexagonais 3/8", fornecido em carril com clips.



Acessórios	carril 165mm, 9 clips para chaves 3/8"		
Bits de caixa	3/8"	hex.	3, 4, 5, 5.5, 6, 7, 8, 10, 12mm

Contém: M381503, M381504, M381505, M3815055, M381506, M381507, M381508, M381510, M381512.

M-3813TPX | € 32,00

Jogo 9 bits de caixa 3/8" TPX, fornecido em carril com clips.



Acessórios	carril 165mm, 9 clips para chaves 3/8"		
Bits de caixa	3/8"	TPX	TPX10, TPX15, TPX20, TPX25, TPX27, TPX30, TPX40, TPX45, TPX50

Contém: M381210, M381215, M381220, M381225, M381227, M381230, M381240, M381245, M381250.



Acessórios	carril 165mm, 9 clips para chaves 3/8"	
Bits de caixa	3/8"	TX10, TX15, TX20, TX25, TX27, TX30, TX40, TX45, TX50
Contém: M381210T, M381215T, M381220T, M381225T, M381227T, M381230T, M381240T, M381245T, M381250T.		

Acessórios	carril 185mm, 9 clips para chaves 3/8"	
Ch. cx. Torx	3/8"	TX10, TX15, TX20, TX25, TX27, TX30, TX40, TX45, TX50
Contém: M382210T-C, M382215T-C, M382220T-C, M382225T-C M382227T-C, M382230T-C, M382240T-C, M382245T-C, M382250T-C		

Acessórios	carril 185mm, 9 clips para chaves 3/8"	
Ch. cx. HEX	3/8"	3, 4, 5, 5-5, 6- 7, 8, 10, 12mm
Contém: M382503-C, M382504-C, M382505-C, M3825055-C, M382506-C, M382507-C, M382508-C, M382510-C, M382512-C		

Acessórios	carril 185mm, 9 clips para chaves 3/8"	
Ch. cx. RIBE	3/8"	4, 5, 6, 8, 9, 10
Contém: M382704-C, M382705-C, M382706-C, M382708-C, M382709-C, M382710-C		

Acessórios	carril 185mm, 9 clips para chaves 3/8"	
Ch. cx. HEX/Bola	3/4"	3, 4, 5, 5-5, 6, 7, 8, 10, 12mm
Contém: M381503BL-C, M381504BL-C, M381505BL-C, M3815055BL-C, M381506BL-C, M381507BL-C, M381508BL-C, M381510BL-C, M381512BL-C		

Acessórios	carril 165mm, 8 clips para chaves 3/8"	
Bits de caixa	3/8"	10mm, 11mm, 12mm, 13mm, 16mm, 17mm, 18mm, 19m
Contém: M386510, M386511, M386512, M386513, M386516, M386517, M386518 M386519,		

M3813TX | € 32,00

Jogo 9 bits de caixa 3/8" TX . fornecido em carril com clips.

**M-3809TX | € 40,00**

Jogo 9 chaves de caixa TX 3/8", fornecido em carril com clips.

**M-3809 | € 39,00**

Jogo 9 chaves de caixa HEX 3/8", fornecido em carril com clips.

**M-3806 | € 34,50**

Jogo 6 chaves de caixa RIBE 3/8", fornecido em carril com clips.

**M-3809HN | € 39,00**

Jogo 9 chaves de caixa TX 3/8", fornecido em carril com clips.

**M3808MM | € 52,00**

Jogo 8 chaves de bocas 3/8". fornecido em carril com clips.



Jogos de 1/2"

T-1220AF | € 130,00

Jogo 20 peças, chaves de caixa 1/2", roquete FRP e acessórios.



Acessórios	1/2"		roquete FRP, junta universal, extensão 2 1/2" e 6", adaptador F3/8":M1/2"
Chaves de caixa	1/2"	12 pontos	3/8", 7/16", 1/2", 9/16", 5/8", 11/16", 3/4", 13/16", 7/8", 15/16", 1", 1 1/8", 1 1/4", 1 1/2", 1 3/4"

Contém: 1200FRP, 120030, M120020, M120021, M380036, M120112, M120114, M120116, M120118, M120120, M120122, M120124, M120126, M120128, M120130, M120132, M120134, M120136, M120138, M120140.

T-1221 e T-1221/6 | € 128,00

Jogo 21 peças, chaves de caixa 1/2", roquete FRP e acessórios.



Acessórios	1/2"		roquete FRP, junta universal, extensão 2 1/2" e 6", adaptador F3/8":M1/2"
Chaves de caixa	1/2"	12 pontos	10, 11, 12, 13, 14, 15, 16, 17, 18, 19, 21, 22, 24, 27, 30, 32mm

Contém T1221 dozeavadas: 1200FRP, 120030, M120020, M120023, M380036, M120510, M120511, M120512, M120513, M120514, M120515, M120516, M120517, M120518, M120519, M120521, M120522, M120524, M120527, M120530, M120532.

Contém T1221-6 sextavadas: 1200FRP, 120030, M120020, M120023, M380036, M1205106, M1205116, M1205126, M1205136, M1205146, M1205156, M1205166, M1205176, M1205186, M1205196, M1205216, M1205226, M1205246, M1205276, M1205306, M1205326.

T-1230 | € 135,00

Jogo 30 peças, chaves de caixa 1/2", roquete FRP e acessórios.



Acessórios	1/2"		roquete FRP, junta universal, extensão 5", adaptador F3/8":M1/2"
Chaves de caixa	1/2"	12 pontos	10, 12, 13, 14, 15, 16, 17, 18, 19, 21, 22, 24, 27, 30, 32mm
	1/2"	12 pontos	3/8", 7/16", 1/2", 9/16", 5/8", 3/4", 13/16", 15/16", 1", 1 1/8", 1 1/4", 1 1/2"

Contém: 1200FRP, 120030, M120021, M380036, M120510, M120512, M120513, M120514, M120515, M120516, M120517, M120518, M120519, M120521, M120522, M120524, M120527, M120530, M120532, M120112, M120114, M120116, M120118, M120120, M120124, M120126, M120130, M120132, M120134, M120136, M120140.

T-1234 | € 205,00

Jogo 34 peças, chaves de caixa sextavadas 1/2", roquete FRP e acessórios.



Acessórios	1/2"		roquete FRP, junta universal, extensão 5" e 10", adaptador F3/8":M1/2"
Chaves de caixa	1/2"	6 pontos	10, 11, 12, 13, 14, 15, 16, 17, 18, 19, 20, 21, 22, 23, 24, 27mm
Ch. cx. longas	1/2"	6 pontos	13, 14, 15, 16, 17, 18, 19, 24mm
Chaves de velas	1/2"	6 pontos	16 e 21mm
Chaves L	hex.		1.5, 2, 2.5mm

Contém: 1200FRP, 120030, M120021, M120022, M380036, M1205106, M1205116, M1205126, M1205136, M1205146, M1205156, M1205166, M1205176, M1205186, M1205196, M1205206, M1205216, M1205226, M1205236, M1205246, M1206136, M1206146, M1206156, M1206166, M1206176, M1206186, M1206196, M1206246, M120040, M120046, 3105015, 310502, 3105025.



Acessórios	1/2"		roquete FRP, cabo articulado, extensões 2½", 5" e 10", junta universal, adaptador F1/2":M3/8", chave luneta 10x13mm, chaves de velas 16 e 21mm
Chaves de caixa	1/2"	12 pontos	10, 11, 12, 13, 14, 15, 16, 17, 18, 19, 20, 21, 22, 23, 24, 27, 30, 32mm
	1/2"	12 pontos	3/8", 1/2", 9/16", 19/32", 11/16", 25/32", 13/16", 1"
Ch. cx. longas	1/2"	12 pontos	10, 13, 17, 19mm
Ch. parafusos			PZ1, PZ2, fendas 5.5, 6.5mm

Contém: 1200FRP, 120030, M120020, M120021, M120022, 1201A, M120036, M120510, M120511, M120512, M120513, M120514, M120515, M120516, M120517, M120518, M120519, M120520, M120521, M120522, M120523, M120524, M120527, M120530, M120532, M120610, M120613, M120617, M120619, M380036, MD922N, MD961N, MD962N.,

Acessórios	1/2"		roquete FRP, junta universal, extensão 2½" e 6", adaptador F1/2":M3/8", chave bits magnética
Chaves de caixa	1/2"	12 pontos	10, 11, 12, 13, 14, 15, 16, 17, 18, 19, 21, 22, 27, 30, 32mm
Ch. boca/luneta			8, 10, 11, 12, 13, 14, 15, 16, 17, 19mm
Ch. parafusos			fendas 3, 5.5, 6mm, PH0, PH1, PH2
Alicates			corte lateral 6", universal 7", pontas 8", bomba de água 10"
Bits 25mm	1/4"	hex	TX8, TX10, TX15, TX20, TX25, TX27, TX30, TX40, TX45, TX50, hex. 3, 4, 5, 6, 8mm, PH0, PH1, PH2, PH3, PZ1, PZ2, PZ3, fendas 4, 5.5, 7mm

Contém: 1200FRP, M120030, M120020, M120023, M120036, M120510, M120511, M120512, M120513, M120514, M120515, M120516, M120517, M120518, M120519, M120521, M120522, M120527, M120530, M120532, 600508, 600510, 600511, 600512, 600513, 600514, 600515, 600516, 600517, 600519, MD920N, MD922N, MD928N1, MD940N, MD947N1, MD948N1, MB441-6, MB452-7, MB461-8, MB481-10, Bits.

Acessórios	1/2"		roquete FRP, extensão 1/2" e extensão de aperto flexível
Chaves de caixa	1/2"	6 pontos	8-9-10, 12, 13, 14, 15, 16, 17, 18, 19, 21, 22, 24, 27, 30, 32mm
	1/2"	Hex	5 a 19mm
chaves		crescente	6" e 12"
ch boca / luneta			8 a 32mm
Alicates			corte diagonal, universal, bomba d'água
Chaves			conjunto de chaves hexagonais
bits			bits sortidos e porta bits
Martelo			bola de 24oz

Contém: 1200FRP, 1201, M120021-C, M1205086-C, M1205106-C, M1205126-C, M1205136-C, M1205146-C, M1205156-C, M1205166-C, M1205176-C, M1205186-C, M1205196-C, M1205216-C, M1205226-C, M1205246-C, M1205256-C, M1205266-C, M1205276-C, M1205306-C, M1205326-C, M121505-C, M121506-C, M121507-C, M121508-C, M121510-C, M121512-C, M121514-C, M121517-C, M121519-C, 600508, 600510, 600511, 600512, 600513, 600514, 600515, 600516, 600517, 600518, 600519, 600521, 600522, 600524, 600525, 600526, 600527, 600530, 600532, 1479MM, 310507BL-C, MD915N, MDR908, HMBP24, 4005, MB441-6, MB452-7, MB482-10Q, TJ1429, MDP125, 585MP

T-1244 | € 256,00

Jogo 44 peças, chaves de caixa 1/2", roquete FRP e acessórios.

**T-1268 | € 330,00**

Jogo 68 peças, chaves de caixa 1/2", roquete FRP e acessórios.

**THDV | € 540,00**

Jogo chaves de caixa 1/2" 105pcs, fornecido em carril com clips.



M-1212N1 | € 75,00

Jogo 12 peças, chaves de caixa sextavadas 1/2", roquete FRP e acessórios.



Acessórios	1/2"	roquete FRP, extensão 5"	
Chaves de caixa	1/2"	6 pontos	8, 10, 12, 13, 14, 15, 17, 18, 19, 24mm

Contém: 1200FRP, M120021, M120508, M120510, M120512, M120513, M120514, M120515, M120517, M120518, M120519, M120524.

M-1215AF | € 51,00

Jogo 15 chaves de caixa 1/2", fornecido em carril com clips.



Acessórios	carril 430mm, 15 clips para chaves 1/2"		
Chaves de caixa	1/2"	12 pontos	3/8", 7/16", 1/2", 9/16", 5/8", 11/16", 3/4", 3/16", 7/8", 15/16", 1", 1 1/16", 1 1/8", 1 3/16", 1 1/4"

Contém: M120112, M120114, M120116, M120118, M120120, M120122, M120124, M120126, M120128, M120130, M120132, M120134, M120136, M120138, M120140.

M-1215MM | € 49,00

Jogo 15 chaves de caixa 1/2", fornecido em carril com clips.



Acessórios	carril 430mm, 15 clips para chaves 1/2"		
Chaves de caixa	1/2"	12 pontos	10, 12, 13, 14, 15, 16, 17, 18, 19, 21, 22, 24, 27, 30, 32mm

Contém: M120510, M120512, M120513, M120514, M120515, M120516, M120517, M120518, M120519, M120521, M120522, M120524, M120527, M120530, M120532.

M-1207 | € 47,00

Jogo 8 chaves de caixa longas 1/2", fornecido em carril com clips.



Acessórios	carril 210mm, 8 clips para chaves 1/2"		
Ch. cx. longas	1/2"	12 pontos	13, 14, 15, 17, 19, 21, 22, 24mm

Contém: M120613, M120614, M120615, M120617, M120619, M120621, M120622, M120624.

M-1208-6 | € 47,00

Jogo 8 chaves de caixa sextavadas longas 1/2", fornecido em carril com clips.



Acessórios	carril 210mm, 8 clips para chaves 1/2"		
Ch. cx. longas	1/2"	6 pontos	13, 14, 15, 16, 17, 18, 19, 24mm

Contém: M1206136, M1206146, M1206156, M1206166, M1206176, M1206186, M1206196, M1206246.



Acessórios	carril 230mm, 9 clips para chaves 1/2"		
Chaves de caixa	1/2"	TX-E	E10, E11, E12, E14, E16, E18, E20, E22, E24
Contém: M120710, M120711, M120712, M120714, M120716, M120718, M120720, M120722, M120724.			

Acessórios	carril 220mm, 9 clips para chaves 1/2"		
Bits de caixa	1/2"	hex	5, 6, 7, 8, 9, 10, 12, 14, 17mm
Contém: M121505, M121506, M121507, M121508, M121509, M121510, M121512, M121514, M121517.			

Acessórios	carril 220mm, 9 clips para chaves 1/2"		
Bits de caixa	1/2"	hex	3/16", 7/32", 1/4", 9/32", 5/16", 3/8", 1/2", 9/16", 5/8"
Contém: M121106, M121107, M121108, M121109, M121110, M121112, M121116, M121118, M121120.			

Acessórios	carril 220mm, 9 clips para chaves 1/2"		
Bits de caixa	1/2"	TPX	TPX20, TPX25, TPX27, TPX30, TPX40, TPX45, TPX50, TPX55, TPX60
Contém: M121220, M121225, M121227, M121230, M121240, M121245, M121250, M121255, M121260.			

Acessórios	carril 220mm, 9 clips para chaves 1/2"		
Bits de caixa	1/2"	TX	TX20, TX25, TX27, TX30, TX40, TX45, TX50, TX55, TX60
Contém: M121220T, M121225T, M121227T, M121230T, M121240T, M121245T, M121250T, M121255T, M121260T.			

Acessórios	carril 160mm, 6 clips para chaves 1/2"		
Bits cx. 100mm	1/2"	hex	5, 6, 7, 8, 10, 12mm
Contém: M122505, M122506, M122507, M122508, M122510, M122512.			

M-1210 | € 32,00

Jogo 9 chaves de caixa TX-E 1/2", fornecido em carril com clips.

**M-1212 | € 35,00**

Jogo 9 bits de caixa 1/2", fornecido em carril com clips.

**M-1209AF | € 35,00**

Jogo 9 bits de caixa hexagonais 1/2", fornecido em carril com clips.

**M-1213TPX | € 35,00**

Jogo 9 bits de caixa TPX 1/2", fornecido em carril com clips.

**M-1213TX | € 35,00**

Jogo 9 bits de caixa TX 1/2", fornecido em carril com clips.

**M-1211 | € 33,00**

Jogo 6 bits de caixa 100mm 1/2", fornecido em carril com clips.



M-1209 | € 56,00

Jogo 9 bits de Ribe 1/2", fornecido em carril com clips.



Acessórios	carril 185mm, 9 clips para chaves 1/2"	
Ch. cx. Ribe	1/2"	4, 5, 6, 8, 9, 10, 11, 12, 13

Contém: M122704-C, M122705-C, M122706-C, M122708-C, M122709-C, M122710-C, M122711-C, M122712-C, M122713-C



M-1209TX | € 55,00

Jogo 9 chaves Torx 1/2", fornecido em carril com clips.



Acessórios	carril 185mm, 9 clips para chaves 1/2"	
Ch. cx. TORX	1/2"	TX20, TX25, TX27, TX27, TX30, TX40, TX45, TX50, TX55, TX60

Contém: M122220T-C, M122225T-C, M122227T-C, M122230T-C, M122240T-C, M122245T-C, M122250T-C, M122255T-C, M122260T-C

Jogos mistos de 1/4"-3/8"-1/2"

M-3814 | € 23,00

Jogo 10 chaves de caixa TX-E 1/4" e 3/8", fornecido em carril com clips.



Acessórios	carril 165mm, 5 clips para chaves 1/4" e 5 clips para chaves 3/8"		
Chaves de caixa	1/4"	TX-E	E4, E5, E6, E7, E8
	3/8"	TX-E	E10, E12, E14, E16, E18

Contém: M140704, M140705, M140706, M140707, M140708, M380710, M380712, M380714, M380716, M380718.

T-1272 | € 205,00

Jogo 72 peças, chaves de caixa e acessórios 1/4" e 1/2".



Acessórios	1/4"		roquete FRP, chave flexível HEX 1/4"xM1/4", extensão 4", adaptador para bits
	1/2"		roquete FRP, extensão 5" e 10", adaptador F3/8":M1/2", adaptador flexível, junta universal
Chaves de caixa	1/4"	6 pontos	4, 5, 5.5, 6, 7, 8, 10, 11, 12, 13mm
	1/2"	12 pontos	10, 11, 12, 13, 14, 15, 16, 17, 18, 19, 20, 21, 22, 23, 24, 27mm
Bits	1/4"	hex	TX8, TX10, TX15, TX20, TX25, TX27, TX30, TX40, hex 3, 4, 5, 6, 8, 10mm, hex 1/8", 9/64", 5/32", 3/16", 7/32", 1/4", 3/8", PH0, PH1, PH2, PH3, PZ1, PZ2, PZ3, fendas 4, 5.5, 7mm, XZN M5, XZN M6

Contém: 1400FRP, 691406, M140021, M140060, 1200FRP, 120021, M120022, M380036, M120080, M120030, M140504, M140505, M1405055, M140506, M140507, M140508, M140510, M140511, M140512, M140513, M120510, M120511, M120512, M120513, M120514, M120515, M120516, M120517, M120518, M120519, M120520, M120521, M120522, M120523, M120524, M120527, 3105015, 310502, 3105025, Bits.



Acessórios	1/4"		roquete FRP, junta universal, extensões 2" e 4", barra T deslizante, chave de bits, adaptador para bits
	1/2"		roquete FRP, extensão 5" e 10", adaptador F3/8":M1/2", junta universal, adaptador p ^a bits 5/16", chave de velas 21mm
Chaves de caixa	1/4"	6 pontos	4, 4.5, 5, 5.5, 6, 7, 8, 9, 10, 11, 12, 13mm
	1/2"	6 pontos	10, 11, 12, 13, 14, 15, 17, 19, 22, 24, 27, 30, 32mm
Ch. cx. longas	1/4"	6 pontos	4, 5, 6, 7, 8, 9, 10, 11, 12, 13mm
Ch. boca/luneta			8, 10, 12, 13, 14, 17mm
Ch. parafusos			PH1x75mm, PH2x100mm, PZ1x75mm, PZ2x100mm, fendas 3x75mm, 4x100mm
Bits	1/4"	hex	fendas 4, 5.5, 7mm, PH0, PH1, PH2, PH3, PH4, PZ0, PZ1, PZ2, PZ3, hex. 3, 4, 5, 6, 8, 10mm, TX8, TX10, TX15, TX20, TX25 TX27, TX30, TX40
	5/16"	hex	TX45, TX50, TX55

TM-095 | € 270,00

Jogo 95 peças, chaves de caixa e acessórios 1/4" e 1/2".



Contém: 1400FRP, M140030, M140020, M140021, M140050, M140015, M140060, 1200FRP, M120021, M120022, M380036, M120030, M120060, M120046, M140504, M1405045, M140505, M1405055, M140506, M140507, M140508, M140509, M140510, M140511, M140512, M140513, M140604, M140605, M140606, M140607, M140608, M140609, M140610, M140611, M140612, M140613, M1205106, M1205116, M1205126, M1205136, M1205146, M1205156, M1205176, M1205196, M1205226, M1205246, M1205276, M1205306, M1205326, 600508, 600510, 600512, 600513, 600514, 600517, MD920N, MD917N, MD947N1, MD948N1, MD961N, MD962N.

Acessórios	1/4"		roquete FRP, adaptador para bits 5/16", extensão flexível 6", extensões 2" e 4", chave de bits, junta universal, adaptador F1/4":M3/8", barra-T 4"
	3/8"		roquete FRP, adaptador bits 1/4", extensões 3" e 6", chave de bits, junta universal, adaptador F3/8":M1/2"
	1/2"		roquete FRP, adaptador bits 5/16", extensões 2 1/2" e 10", adaptador F1/2":M3/8"
Chaves de caixa	1/4"	6 pontos	4, 5, 6, 7, 8, 10, 12mm 3/16" 7/32" 1/4" 9/32" 3/8" 7/16"
	3/8"	6 pontos	8, 9, 10, 12, 13, 14, 15, 16, 17mm 3/8" 7/16" 1/2" 9/16" 11/16" 3/4" 13/16" 7/8"
Ch. cx. longas	1/2"	6 pontos	17, 24, 27, 32mm 11/16" 3/4" 13/16" 7/8" 1" 1 3/16"
	3/8"	6 pontos	8, 9, 10, 12, 13, 14, 15, 16, 17mm 3/8" 7/16" 1/2" 9/16" 11/16" 3/4" 13/16" 7/8"
Ch. de velas	3/8"	6 pontos	16, 21mm
Bits	5/16"	hex	hex 3, 4, 5, 6, 7, 10mm, hex. 1/8", 9/64", 5/32", 3/16", 1/4", 5/16", TX10, TX15, TX20, TX25, TX30, TX40, fendas 4, 5.5, 7mm, PH1, PH2, PH3, PZ1, PZ2, PZ3
	5/16"	hex	TX45, TX50

TM-111 | € 375,00

Jogo 111 peças, chaves de caixa e acessórios 1/4", 3/8" e 1/2".



Contém: 1200FRP, 1400FRP, 3800FRP, M120020, M120022, M120036, M120060, M120122, M120124, M120126, M120128, M120132, M120138, M120517, M120524, M120527, M120532, M140015, M140020, M140021, M140030, M140036, M140038, M140050, M140060, M140106, M140107, M140108, M140109, M140112, M140114, M140504, M140505, M140506, M140507, M140508, M140510, M140512, M380015, M380020, M380021, M380030, M380036, M380040, M380046, M380060, M380112, M380114, M380116, M380118, M380122, M380124, M380126, M380128, M380212, M380214, M380216, M380218, M380222, M380224, M380226, M380228, M380508, M380510, M380512, M380513, M380514, M380515, M380516, M380517, M380608, M380609, M380610, M380612, M380613, M380614, M380615, M380616, M380617, Bits.



TM-127 | € 306,00

Jogo 127 peças, chaves de caixa e acessórios 1/4", 3/8" e 1/2".



Contém: 1400FRP, M140030, M140020, M140023, M140060, 3800FRP, M380030, M380020, M380021, M380035, M380036, M380060, M120020, M120022, M120036, M120080, M140504, M140505, M1405055, M140506, M140507, M140508, M140510, M140511, M140512, M140513, M140106, M140107, M140108, M140109, M140110, M140111, M140112, M140114, M140116, M380508, M380509, M380510, M380512, M380513, M380514, M380515, M380516, M380517, M380518, M380519, M380519, M380521, M380522, M380110, M380112, M380114, M380116, M380118, M380120, M380122, M380124, M380126, M380128, M120519, M120524, M120527, M120530, M120532, M140606, M140607, M140608, M140610, M140612, M140613, M380040, M380046, 600508, 600509, 600510, 600511, 600512, 600513, 600514, 600515, 600516, 600517, 600518, 600519, 600, 4003WT, Bits.

Acessórios	1/4"		roquete FRP, junta universal, extensões 2" e 3", adaptador para bits, chave de bits com roquete
	3/8"		roquete FRP, junta universal, extensões 3" e 6", adaptador para bits, velas 16 e 21mm, adaptadores F3/8":M1/4" e F3/8":M1/2"
	1/2"		extensões 2 1/2" e 10", adaptador flexível, adaptador F1/2":M3/8"
Chaves de caixa	1/4"	6 pontos	4, 5, 5.5, 6, 7, 8, 10, 11, 12, 13mm
		6 pontos	3/16", 7/32", 1/4", 9/32", 5/16", 11/32", 3/8", 7/16", 1/2"
	3/8"	6 pontos	8, 9, 10, 11, 12, 13, 14, 15, 16, 17, 18, 19, 21, 22mm
		6 pontos	5/16", 3/8", 7/16", 1/2", 9/16", 5/8", 11/16", 3/4", 13/16", 7/8"
	1/2"	12 pontos	19, 24, 27, 30, 32mm
Ch. cx. longas	1/4"	6 pontos	6, 7, 8, 10, 12, 13mm
Chaves			boca/luneta 8, 9, 10, 11, 12, 13, 14, 15, 16, 17, 18, 19mm, chave crescente 8"
Bits	1/4"	hex	fendas 4 (x 2), 5.5 (x 2), 7mm(x 2), PH0, PH1 (x 2) PH2 (x 2), PH3, PZ1 (x 2), PZ2 (x 2), PZ3, hex. 3, 4, 5, 6, 8, 10mm, hex. 1/8", 9/64", 5/32", 3/16", 1/4", 3/8", TX8, TX10, TX15, TX20, TX25, TX27, TX30, TX40, XZN 5 e 6.

TM-106 | € 390,00

Jogo 106 peças, chaves de caixa e acessórios 1/4", 3/8" e 1/2".



Contém: 1400FRP, M140030, M140020, M140023, M140060, MD900, 3800FRP, M380030, M380020, M380021, M380035, M380036, M380060, M120020, M120022, M120036, M120080, M140504, M140505, M140506, M140507, M140508, M140510, M140512, M140513, M380508, M380509, M380510, M380512, M380513, M380514, M380515, M380516, M380517, M380518, M380519, M380521, M380522, M120519, M120524, M120527, M120530, M120532, M140606, M140607, M140608, M140610, M140612, M140613, M380040, M380046, 600508, 600509, 600510, 600511, 600512, 600513, 600514, 600515, 600516, 600517, 600518, 600519, 600, 650809, 651011, 651213, 651415, 4004IQ, Bits.

Acessórios	1/4"		roquete FRP, junta universal, extensões 2" e 3", adaptador para bits, punho para bits
	3/8"		roquete FRP, junta universal, extensões 3" e 6", adaptadores F3/8":M 1/4", F3/8":M1/2", adaptador para bits
	1/2"		extensões 2 1/2" e 10", adaptador F1/2":M3/8", adaptador flexível
Chaves de caixa	1/4"	6 pontos	4, 5, 6, 7, 8, 10, 12, 13mm
	3/8"	6 pontos	6, 7, 8, 10, 12, 13mm
	1/2"	12 pontos	8, 9, 10, 12, 13, 14, 15, 16, 17, 18, 19, 21, 22mm
Ch. cx. longas	1/4"	6 pontos	6, 7, 8, 10, 12, 13mm
Chaves de velas	3/8"		18, 21mm
Bits	1/4"	hex	fendas 4, 5.5, 7mm, hex 3, 4, 5, 6, 8, 10mm, TX8, TX10, TX15, TX20, TX25, TX27, TX30, TX40, PH0, PH1, PH2, PH3, TPX10, TPX15, TPX20, TPX25, TPX27, TPX30, TPX40, PZ1, PZ2, PZ3, XZN5, 6
Chaves			boca/luneta 8, 9, 10, 11, 12, 13, 14, 15, 16, 17, 18, 19mm, flexíveis HEX1/4":M1/4", 8x9, 10x11, 12x13, 14x15mm, crescente 10"



Jogos de 3/4"

Acessórios	3/4"		roquete 72 dentes, extensões 200 e 400mm, barra-T deslizante
Chaves de caixa	3/4"	6 pontos	19, 21, 22, 24, 27, 30, 32, 33,34, 36, 38, 41, 46, 50mm

Contém: M3400-72, M340021, M340022, M340050, M3405196, M3405216, M3405226, M3405246, M3405276, M3405306, M3405326, M3405336, M3405346, M3405366, M3405386, M3405416, M3405466, M3405506.

T-3418-6 | € 415,00

Jogo 18 peças, chaves de caixa sextavadas 3/4", roquete 72 dentes e acessórios.



Acessórios	3/4"		roquete 72 dentes, extensões 100, 200 e 400mm, barra-T deslizante
Chaves de caixa	3/4"	6 pontos	19, 21, 24, 27, 32, 34, 36, 50mm
	3/4"	12 pontos	7/8", 1", 1 1/8", 1 1/4", 1 1/2", 1 3/4", 1 7/8", 2"

Contém: M3400-72, M340020S, M340021S, M340022S, M340050S, M3405196, M3405216, M3405246, M3405276, M3405326, M3405346, M3405366, M3405506, M340128, M340132, M340136, M340138, M340142, M340148, M340152, M340158, M340164.

T-3422S | € 430,00

Jogo 22 peças, chaves de caixa 3/4", roquete 72 dentes e acessórios.



Jogos de 1"

Acessórios	1"		cabeça de roquete, cabo 22", adaptador barra-T, extensões 200 e 400mm
Chaves de caixa	1"	12 pontos	36, 41, 46, 50, 55, 60, 65, 70, 75, 80mm

Contém: M110010, M110020, M110040, M110050, M110536, M110541, M110546, M110550, M110555, M110560, M110565, M110570, M110575, M110580.

M-1115MM | € 625,00

Jogo 15 peças, chaves de caixa 1" e acessórios.



1/4"

PM-14 | € 11,50

Mini roquete 1/4", reversível, **sem engrenagem**. Ideal para uso não intensivo.



RHA-14 | € 17,30

Mini cabeça de roquete 72 dentes, com quadra de 1/4" de um lado e 1/4" hexagonal para bits do outro, encaixe 1/4" hexagonal, 50mm Conforme DIN3122D.



1400-M | € 21,00

Mini roquete 1/4", reversível, 45 dentes, 76mm de comprimento e 29mm de altura. Ideal para uso em espaços restritos.



1400-B | € 22,00

Mini roquete reversível 1/4" hexagonal, com chave luneta 8mm, 90mm de comprimento. Cromo vanádio (Cr-V), acabamento acetinado.



1400-72MN | € 35,00

Mini roquete 1/4", reversível, 72 dentes, 93mm de comprimento, cabo bi-material. Ideal para uso em espaços restritos. Conforme DIN3122D.



Roquetes 72 dentes

Roquetes 72 dentes (incrementos 8°), reversíveis, design esguio com cabo bi-material.

nº Stock	Quadra	DIN	Descrição	Dentes	Comprimento mm	Peso g	Preço
1400-72N	1/4"	3122D	reversível	72	150	110	€ 39,00



Roquetes articulados 72 dentes

Roquetes 72 dentes (incrementos 5°), cabeça articulada, com cabo bi-material.

nº Stock	Quadra	DIN	Descrição	Dentes	Comprimento mm	Peso g	Preço
1400-72SN	1/4"	3122D	reversível	72	121	114	€ 37,00



Roquetes FRP

Roquetes de aço com reforço em fibra, 45 dentes (incrementos 8°), reversíveis, com sistema de encaixe rápido, cabo ergonómico bi-material.

nº Stock	Quadra	DIN	Descrição	Dentes	Torque max. Nm	Comprimento mm	Preço
1400-FRP	1/4"	3122D	reversível c/ sis. encaixe rápido	45	62	121	€ 27,00



Roquetes Longos

Roquetes de aço com reforço em fibra, 43 dentes (incrementos 8°), reversíveis, com sistema de encaixe rápido, cabo ergonómico bi-material.

nº Stock	Quadra	DIN	Descrição	Dentes	Comprimento mm	Preço
1400-L	1/4"	3122D	reversível c/ sis. encaixe rápido	43	200	€ 25,00
1400-F	1/4"	3122D	reversível c/ sis. encaixe rápido	43	200	€ 30,00



Extensões 1/4"



nºStock	Quadra	Tipo	DIN	Descrição	Comprimento mm	Peso g	Preço
M-140020-C	1/4"	A	3123B	2" extensão	50	22	€ 2,85
M-140023-C	1/4"	A	3123B	3" extensão	75	35	€ 3,2
M-140021-C	1/4"	A	3123B	4" extensão	100	46	€ 3,5
M-140022-C	1/4"	A	3123B	6" extensão	150	65	€ 3,9
M-140024-C	1/4"	C	3123B	12" extensão	305	126	€ 8,00
M-140038-C	1/4"	-	3123B	6" extensão flexível, com protecção	150	26	€ 8,00



nºStock	Quadra	DIN	Descrição	Comprimento mm	Peso g	Preço
M-140050-C	1/4"	3122A	barra T deslizante 1/4"	106	40	€ 5,20

nºStock	Quadra	DIN	Descrição	Comprimento mm	Peso g	Preço
M-140030-C	1/4"	3123C	junta universal 1/4"	33	23	€ 8,00

nºStock	DIN	Quadra	Descrição adaptadores	Furação barra T	Comprimento mm	Peso g	Preço
M-140036-C	-	1/4"	1/4" fêmea:3/8" macho	-	25.0	20	€ 2,80
M-140037-C	-	1/4"	1/4" macho:1/4" hex	-	25.0	7	€ 0,70
M-140039-C	-	1/4"	1/4" macho:1/4" hex	-	30.0	7	€ 2,50

nºStock	Quad	DIN	Descrição	Comp. mm	Peso g	Preço
M-140060-C	1/4"	3126	adaptador para bits 1/4" hexagonais	25	20	€ 3,20

nºStock	Quadra	DIN	Descrição	Comprimento mm	Peso g	Preço
MD-514N	1/4"	-	chave de aperto flexível	106	40	€ 9,50
MD-514L	1/4"	-	chave de aperto flexível	555	213	€ 14,50
M-140015-C	1/4"	3122E	chave de aperto com haste 6"	170	122	€ 7,00



Chaves de Caixa 1/4"

Chaves de caixa métricas 1/4", 6 pontos, aço-vanádio cromado, acabamento acetinado. DIN 3120/3124, ISO 2725.

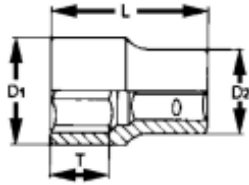

nºStock	Medida mm	L mm	T mm	D1 mm	D2 mm	Peso g	Preço
M-140504-C	4	25.0	3.6	6.9	12.0	10	€ 1,90
M-1405045-C	4.5	25.0	3.6	7.5	12.0	12	€ 1,90
M-140505-C	5	25.0	4.2	8.1	12.0	12	€ 1,90
M-1405055-C	5.5	25.0	4.2	8.8	12.0	12	€ 1,90
M-140506-C	6	25.0	4.8	9.4	12.0	12	€ 1,90
M-140507-C	7	25.0	4.0	10.9	12.0	13	€ 1,90
M-140508-C	8	25.0	4.0	12.0	12.0	13	€ 1,90
M-140509-C	9	25.0	4.5	13.2	13.2	13	€ 1,90
M-140510-C	10	25.0	6.0	14.7	14.7	17	€ 1,90
M-140511-C	11	25.0	6.0	16.0	16.0	20	€ 1,90
M-140512-C	12	25.0	7.0	16.9	16.9	21	€ 2,00
M-140513-C	13	25.0	7.5	17.7	17.7	24	€ 2,40

Chaves de Caixa 1/4"

Chaves de caixa em polegadas 1/4", 6 pontos, aço-vanádio cromado, acabamento acetinado. DIN 3120/3124, ISO 2725.

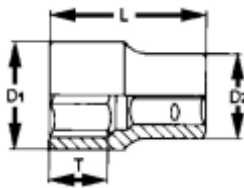

nºStock	Medida	L mm	T mm	D1 mm	D2 mm	Peso g	Preço
M-140106-C	3/16"	25.0	3.6	8.0	12.0	12	€ 1,80
M-140107-C	7/32"	25.0	4.2	8.8	12.0	12	€ 1,80
M-140108-C	1/4"	25.0	4.8	10.0	12.0	12	€ 1,80
M-140109-C	9/32"	25.0	4.0	10.9	12.0	13	€ 1,80
M-140110-C	5/16"	25.0	4.0	12.0	12.0	13	€ 1,80
M-140111-C	11/32"	25.0	4.5	13.2	13.2	18	€ 1,80
M-140112-C	3/8"	25.0	4.5	14.7	14.4	19	€ 1,80
M-140114-C	7/16"	25.0	6.0	16.0	16.0	22	€ 2,20
M-140116-C	1/2"	25.0	7.2	17.7	17.7	28	€ 2,20

Chaves de Caixa TX-E 1/4"

Chaves de caixa TX-E 1/4", aço-vanádio cromado, acabamento acetinado.

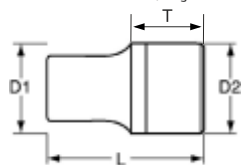

nºStock	Medida	Medida mm	L mm	T mm	D1 mm	D2 mm	Peso g	Preço
M-140704-C	E4	3.83	23.1	3.5	5.8	12.0	7	€ 2,95
M-140705-C	E5	4.73	24.8	4.5	6.8	12.0	8	€ 2,95
M-140706-C	E6	5.74	24.8	4.5	8.0	12.0	9	€ 2,95
M-140707-C	E7	6.16	24.8	5.6	9.4	12.0	10	€ 2,95
M-140708-C	E8	7.52	24.8	6.0	10.4	12.0	10	€ 2,95



Chaves de Caixa Longas 1/4"

Chaves de caixa métricas 1/4", 6 pontos, aço-vanádio cromado, acabamento acetinado. DIN 3120/3124, ISO 2725.

nºStock	Medida mm	L mm	T mm	D1 mm	D2 mm	Peso g	Preço
M-140604-C	4	49.5	5.0	8.0	11.8	23	€ 4,00
M-140605-C	5	49.5	5.5	8.0	11.8	25	€ 4,00
M-1406055-C	5.5	49.5	5.5	8.8	11.8	26	€ 4,00
M-140606-C	6	49.5	6.5	9.4	11.8	26	€ 4,00
M-140607-C	7	49.5	10.5	10.9	11.8	27	€ 4,00
M-140608-C	8	49.5	10.5	11.8	11.8	30	€ 4,00
M-140609-C	9	49.5	11.5	12.8	12.8	37	€ 4,00
M-140610-C	10	49.5	13.0	14.5	14.5	38	€ 4,00
M-140611-C	11	49.5	14.0	15.6	15.6	43	€ 4,00
M-140612-C	12	49.5	15.0	16.6	16.6	46	€ 4,00
M-140613-C	13	49.5	17.0	17.6	17.6	48	€ 4,40

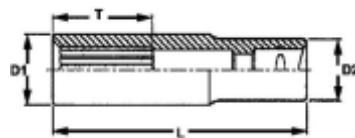
**Chaves de Caixa Longas 1/4"**

Chaves de caixa medida em polegadas 1/4", 6 pontos, aço-vanádio cromado, acabamento acetinado. DIN 3120/3124, ISO 2725.

nºStock	Medida	L mm	T mm	D1 mm	D2 mm	Peso g	Preço
M-140206-C	3/16"	49.5	5.0	8.0	11.8	24	€ 3,70
M-140207-C	7/32"	49.5	5.5	8.8	11.8	26	€ 3,70
M-140208-C	1/4"	49.5	6.5	10.0	11.8	27	€ 3,70
M-140209-C	9/32"	49.5	5.5	10.8	11.8	26	€ 3,70
M-140210-C	5/16"	49.5	10.5	11.8	11.8	30	€ 3,70
M-140211-C	11/32"	49.5	11.5	12.8	11.8	34	€ 3,70
M-140212-C	3/8"	49.5	12.5	14.5	14.5	37	€ 3,70
M-140214-C	7/16"	49.5	14.5	15.8	15.8	44	€ 3,70
M-140216-C	1/2"	49.5	16.5	17.6	17.6	48	€ 4,00

**Bits Philips 1/4"**

Bits PH com quadra de 1/4", aço-vanádio cromado, acabamento acetinado.

nºStock	Medida	L1 mm	L2 mm	D mm	Peso g	Preço
M-141300-C	PH0	32.0	15.0	12.0	13	€ 2,45
M-141301-C	PH1	32.0	15.0	12.0	13	€ 2,45
M-141302-C	PH2	32.0	15.0	12.0	13	€ 2,45
M-141303-C	PH3	32.0	15.0	12.0	13	€ 2,45

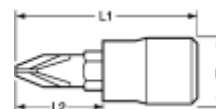

Bits Fenda 1/4"

Bits de fenda com quadra de 1/4", aço-vanádio cromado, acabamento acetinado.



nºStock	Medida	Espes. mm	L1 mm	L2 mm	D mm	Peso g	Preço
M-141404-C	4.0	0.76	32.0	15.0	12.0	13	€ 2,45
M-1414055-C	5.5	0.99	32.0	15.0	12.0	13	€ 2,45
M-141407-C	7.0	1.4	32.0	15.0	12.0	14	€ 2,45



Bits Pozidrive 1/4"

Bits PZ com quadra de 1/4", aço-vanádio cromado, acabamento acetinado.

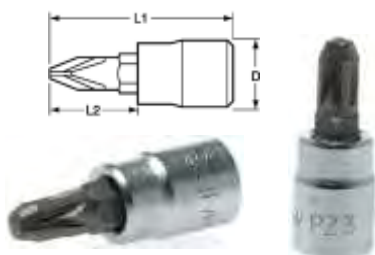

nºStock	Medida	L1 mm	L2 mm	D mm	Peso g	Preço
M-141601-C	PZ1	32.0	15.0	12.0	13	€ 2,50
M-141602-C	PZ2	32.0	15.0	12.0	13	€ 2,50
M-141603-C	PZ3	32.0	15.0	12.0	13	€ 2,50

Bits Torx 1/4"

Bits TX com quadra de 1/4", aço-vanádio cromado, acabamento acetinado.



nºStock	Medida	Medida mm	L1 mm	L2 mm	D mm	Peso g	Preço
M-141210T-C	TX10	2.5	32.0	15.0	12.0	13	€ 2,90
M-141215T-C	TX15	3.0	32.0	15.0	12.0	13	€ 2,90
M-141220T-C	TX20	3.5	32.0	15.0	12.0	13	€ 2,90
M-141225T-C	TX25	4.5	32.0	15.0	12.0	13	€ 2,95
M-141227T-C	TX27	5.0	32.0	15.0	12.0	14	€ 2,95
M-141230T-C	TX30	5.5	32.0	15.0	12.0	14	€ 2,95
M-141240T-C	TX40	6.5	32.0	15.0	12.0	14	€ 3,20

Bits Hex 1/4"

Bits HEX com quadra de 1/4", aço-vanádio cromado, acabamento acetinado.



nºStock	Medida	Medida mm	L1 mm	L2 mm	D mm	Peso g	Preço
M-141503-C	HEX	3,0	32.0	14.0	12.0	13	€ 3,30
M-141504-C	HEX	4.0	32.0	14.0	12.0	13	€ 3,30
M-141505-C	HEX	5,0	32.0	14.0	12.0	13	€ 3,30
M-1415055-C	HEX	5.5	32.0	14.0	12.0	13	€ 3,30
M-141506-C	HEX	6.0	32.0	14.0	12.0	14	€ 3,30
M-141507-C	HEX	7,0	32.0	14.0	12.0	14	€ 3,35
M-141508-C	HEX	8,0	32.0	14.0	12.0	14	€ 3,35
M-141510-C	HEX	10,0	32.0	14.0	12.0	14	€ 3,50
M-141512-C	HEX	12,0	32.0	14.0	12.0	14	€ 3,90



3/8"

Roquetes 72 dentes

Roquetes 72 dentes (incrementos 8°), reversíveis, design esguio com cabo bi-materia.



nº Stock	Quadra	DIN	Descrição	Dentes	Comprimento mm	Peso g	Preço
3800-72N	3/8"	3122D	reversível c/ sis. encaixe rápido	72	203	265	€ 45,00

Roquetes articulados 72 dentes

Roquetes 72 dentes (incrementos 5°), cabeça articulada, com cabo bi-materia.



nº Stock	Quadra	Descrição	Dentes	Comprimento mm	Peso g	Preço
3800-72SN	3/8"	reversível com sistema de encaixe rápido	72	178	270	€ 42,00

Roquetes FRP

Roquetes de aço com reforço em fibra, 45 dentes (incrementos 8°), reversíveis, com sistema de encaixe rápido, cabo ergonómico bi-material.



nº Stock	Quadra	DIN	Descrição	Dentes	Torque max. Nm	Comprimento mm	Preço
3800-FRP	3/8"	3122D	reversível c/ sis. encaixe rápido	45	202	178	€ 35,00

Roquetes Longos

Roquetes de aço com reforço em fibra, 41 dentes (incrementos 8°), reversíveis, com sistema de encaixe rápido, cabo ergonómico bi-material.

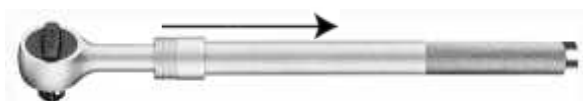

nº Stock	Quadra	DIN	Descrição	Dentes	Comprimento mm	Preço
3800-41E	3/8"	3122D	Extensível rev. c/ sis. encaixe rápido	41	250-356	€ 39,00
3800-L	3/8"	3122D	reversível c/ sis. encaixe rápido	41	300	€ 31,00
3800-F	3/8"	3122D	reversível c/ sis. encaixe rápido	41	300	€ 37,00

Extensões 3/8"



nº Stock	Quadra	Tipo	DIN	Descrição	Comprimento mm	Peso g	Preço
M-380020-C	3/8"	A	3123B	3" extensão	75	75	€ 3,80
M-380023-C	3/8"	A	3123B	5" extensão	125	120	€ 4,90
M-380021-C	3/8"	A	3123B	6" extensão	150	145	€ 5,30
M-380022-C	3/8"	A	3123B	10" extensão	254	242	€ 7,70





nºStock	Quadra	Tipo	DIN	Descrição	Comprimento mm	Peso g	Preço
M-380020W-C	3/8"	B	-	3" extensão angular	75	63	€ 7,80
M-380021W-C	3/8"	B	-	6" extensão angular	150	145	€ 8,60
M-380022W-C	3/8"	B	-	10" extensão angular	255	234	€ 10,50



nºStock	Quadra	Tipo	DIN	Descrição	Comprimento mm	Peso g	Preço
M-380024-C	3/8"	C	3123B	20" extensão	500	506	€ 25,90



nºStock	Quadra	DIN	Descrição	Comprimento mm	Peso g	Preço
M-380050-C	3/8"	3122A	barra T deslizante 3/8"	170	122	€ 9,50



nºStock	Quadra	DIN	Descrição	Comprimento mm	Peso g	Preço
M-380030-C	3/8"	3123C	junta universal 3/8"	50	65	€ 9,70



nºStock	DIN	Quadra	Descrição Adaptadores	Furação barra T	Comprimento mm	Peso g	Preço
M-380035-C	3123A	3/8"	3/8" fêmea:1/4" macho	Sim	25.4	20	€ 4,00
M-380036-C	3123A	3/8"	3/8" fêmea:1/2" macho	Sim	36.0	45	€ 5,40
M-380037-C	-	3/8"	hex:3/8" macho	-	32.0	14	€ 1,80



nºStock	Quad	DIN	Descrição	Comprim. mm	Peso g	Preço
M-380060-C	3/8"	3126	adaptador para bits 1/4" hexagonais	28	32	€ 3,50
M-380061-C	3/8"	3126	adaptador para bits 10mm hexagonais	28	32	€ 4,20



nºStock	Quadra	Descrição	Comprimento mm	Peso g	Preço
T-HD	3/8"	punho para uso em extensões tipo C	120	32	€ 1,70



nºStock	Quadra	DIN	Descrição	Comprimento mm	Peso g	Preço
M-380010A-C	3/8"	-	chave articulada 10", haste curva	250	375	€ 21,00
M-380011-C	3/8"	-	manivela 3/8"	380	310	€ 12,50





PT3810R com quadra fêmea de 3/8" na parte posterior da chave, para usar com roquete ou barra T.

nºStock	Quadra	DIN	Descrição	Comprimento mm	Peso g	Preço
M-380015-C	3/8"	3122E	chave de aperto com haste 10"	243	300	€ 11,60
PT-3810R	3/8"	3122E	chave de aperto rotativa	253	302	€ 14,50

Chaves de Caixa 3/8"

Chaves de caixa métricas 3/8", 6 pontos, aço-vanádio cromado, acabamento acetinado. DIN 3120/3124, ISO 2725.

nºStock	Medida mm	L mm	T mm	D1 mm	D2 mm	Peso g	Preço
M-380507-C	7	25.7	4.0	10.8	17.1	21	€ 2,40
M-380508-C	8	25.7	4.5	12.0	17.1	25	€ 2,40
M-380509-C	9	25.7	5.0	13.1	17.1	26	€ 2,60
M-380510-C	10	25.7	5.0	14.7	17.1	26	€ 2,60
M-380511-C	11	25.7	7.0	16.0	17.1	26	€ 2,60
M-380512-C	12	25.7	7.0	17.1	17.1	29	€ 2,60
M-380513-C	13	25.7	7.0	18.3	18.3	32	€ 2,60
M-380514-C	14	25.7	9.0	19.5	19.5	40	€ 2,70
M-380515-C	15	25.7	10.0	20.4	20.4	43	€ 2,70
M-380516-C	16	29.0	10.0	22.1	22.1	43	€ 2,70
M-380517-C	17	29.0	10.0	23.3	23.3	50	€ 3,30
M-380518-C	18	29.0	15.5	24.2	20.0	56	€ 3,40
M-380519-C	19	29.0	15.5	25.7	21.0	64	€ 3,50
M-380520-C	20	29.0	15.5	26.7	22.0	71	€ 3,90
M-380521-C	21	29.0	15.5	27.7	23.0	78	€ 3,90
M-380522-C	22	29.0	15.5	29.8	24.0	82	€ 4,00

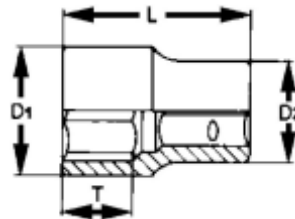

Chaves de Caixa 3/8"

Chaves de caixa em polegadas 3/8", 6 pontos, aço-vanádio cromado, acabamento acetinado. DIN 3120/3124, ISO 2725.

nºStock	Medida	L mm	T mm	D1 mm	D2 mm	Peso g	Preço
M-380110-C	5/16"	25.7	4.5	11.7	17.1	23	€ 2,70
M-380112-C	3/8"	25.7	5.0	14.2	17.1	24	€ 2,70
M-380114-C	7/16"	25.7	7.0	16.3	17.1	26	€ 2,70
M-380116-C	1/2"	25.7	7.0	18.3	18.3	34	€ 2,70
M-380118-C	9/16"	25.7	9.0	19.5	19.5	38	€ 2,70
M-380120-C	5/8"	29.0	10.0	22.1	22.1	46	€ 2,70
M-380122-C	11/16"	29.0	10.0	24.2	20.0	50	€ 3,30
M-380124-C	3/4"	29.0	12.0	25.7	21.0	60	€ 3,60
M-380126-C	13/16"	29.0	13.0	27.7	23.0	68	€ 4,00
M-380128-C	7/8"	29.0	13.0	29.5	24.0	75	€ 4,00

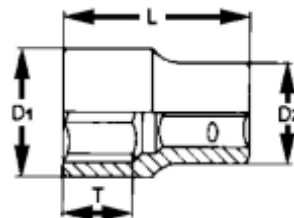

Chaves de Caixa Longas 3/8"

Chaves de caixa métricas 3/8", 6 pontos, aço-vanádio cromado, acabamento acetinado. DIN 3120/3124, ISO 2725.

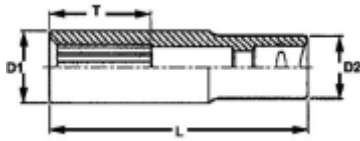

nºStock	Medida mm	L mm	T mm	D1 mm	D2 mm	Peso g	Preço
M-380607-C	7	45.5	10.0	10.8	16.5	40	€ 3,80
M-380608-C	8	45.5	12.0	12.0	16.5	50	€ 3,90
M-380609-C	9	45.5	14.0	13.1	16.5	55	€ 3,90
M-380610-C	10	45.5	15.0	14.7	16.5	60	€ 3,90
M-380611-C	11	45.5	17.0	16.5	16.5	70	€ 3,90
M-380612-C	12	45.5	18.0	17.1	17.1	75	€ 4,00
M-380613-C	13	45.5	18.0	18.5	18.5	85	€ 4,00
M-380614-C	14	50.0	18.0	19.5	19.5	95	€ 4,30
M-380615-C	15	53.0	20.0	20.4	20.4	100	€ 4,30
M-380616-C	16	53.0	20.0	22.0	22.0	105	€ 4,80
M-380617-C	17	56.0	20.0	23.3	23.3	120	€ 5,10
M-380618-C	18	56.0	20.0	24.2	24.2	125	€ 5,30
M-380619-C	19	56.0	20.0	25.7	25.7	130	€ 5,60
M-380620-C	20	63.5	22.0	26.8	26.8	140	€ 6,00
M-380621-C	21	63.5	22.0	27.7	27.7	165	€ 6,00
M-380622-C	22	63.5	22.0	29.5	29.5	165	€ 6,50

Chaves de Caixa Longas 3/8"

Chaves de caixa em polegadas 3/8", 6 pontos, aço-vanádio cromado, acabamento acetinado. DIN 3120/3124, ISO 2725.



nºStock	Medida	L mm	T mm	D1 mm	D2 mm	Peso g	Preço
M-380212-C	3/8"	45.5	15.0	14.2	16.5	43	€ 3,70
M-380214-C	7/16"	45.5	17.0	16.5	16.5	50	€ 3,70
M-380216-C	1/2"	45.5	18.0	18.5	18.5	62	€ 3,90
M-380218-C	9/16"	50.0	18.0	19.5	19.5	72	€ 4,00
M-380220-C	5/8"	53.0	20.0	22.0	22.0	97	€ 4,20
M-380222-C	11/16"	56.0	20.0	24.2	24.2	125	€ 5,40
M-380224-C	3/4"	56.0	22.0	25.7	25.7	130	€ 5,90
M-380226-C	13/16"	63.5	22.0	27.7	27.7	140	€ 5,90
M-380228-C	7/8"	63.5	22.0	29.5	29.5	165	€ 6,00

Chaves de Caixa TX-E 3/8"

Chaves de caixa TX-E 3/8", aço-vanádio cromado, acabamento acetinado.

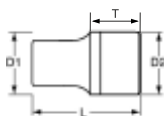

nºStock	Medida	Medida mm	L mm	T mm	D1 mm	D2 mm	Peso g	Preço
M-380710-C	E10	9.42	28.0	7.2	13.0	17.0	25	€ 4,40
M-380712-C	E12	11.17	28.0	7.7	15.0	17.0	25	€ 4,40
M-380714-C	E14	12.90	28.0	9.6	16.3	18.0	30	€ 4,40
M-380716-C	E16	14.76	28.0	10.8	20.0	20.0	35	€ 4,40
M-380718-C	E18	16.70	28.0	12.0	22.0	22.0	40	€ 4,50



Bits Hexagonais 3/8"

Bits hexagonais com quadra de 3/8", aço-vanádio cromado, acabamento acetinado. DIN 7422.

nºStock	Medida mm	L1 mm	L2 mm	D mm	Peso g	Preço
M-381503-C	3	49.5	23.0	17.9	38	€ 4,00
M-381504-C	4	49.5	23.0	17.9	38	€ 4,00
M-381505-C	5	49.5	23.0	17.9	38	€ 4,00
M-3815055-C	5.5	49.5	23.0	17.9	38	€ 4,00
M-381506-C	6	49.5	23.0	17.9	38	€ 4,00
M-381507-C	7	49.5	23.0	17.9	40	€ 4,00
M-381508-C	8	49.5	23.0	17.9	44	€ 4,00
M-381510-C	10	49.5	23.0	17.9	52	€ 4,00
M-381512-C	12	49.5	23.0	22.0	56	€ 7,20

**Bits Hexagonais 3/8"**

Bits hexagonais com quadra de 3/8", medida em polegadas, aço-vanádio cromado, acabamento acetinado.

nºStock	Medida	L1 mm	L2 mm	D mm	Peso g	Preço
M-381103-C	3/32"	49.5	23.0	17.9	38	€ 3,90
M-381104-C	1/8"	49.5	23.0	17.9	38	€ 3,90
M-381105-C	5/32"	49.5	23.0	17.9	38	€ 3,90
M-381106-C	3/16"	49.5	23.0	17.9	38	€ 3,90
M-381107-C	7/32"	49.5	23.0	17.9	38	€ 3,90
M-381108-C	1/4"	49.5	23.0	17.9	38	€ 3,90
M-381110-C	5/16"	49.5	23.0	17.9	44	€ 4,00
M-381112-C	3/8"	49.5	23.0	17.9	44	€ 4,00

**Bits Hexagonais 3/8"**

Bits hexagonais com quadra de 3/8", medida em polegadas, aço-vanádio cromado, acabamento acetinado.

nºStock	Medida mm	L1 mm	L2 mm	D mm	Peso g	Preço
M-382503-C	3	100	74	17.9	50	€ 5,60
M-382504-C	4	100	74	17.9	50	€ 5,60
M-382505-C	5	100	74	17.9	50	€ 5,60
M-3825055-C	5.5	100	74	17.9	50	€ 5,60
M-382506-C	6	100	74	17.9	50	€ 5,60
M-382507-C	7	100	74	17.9	55	€ 5,70
M-382508-C	8	100	74	17.9	66	€ 5,80
M-382510-C	10	100	74	17.9	86	€ 6,40
M-382512-C	12	100	74	22.0	130	€ 7,50



Bits Torx com Furo 3/8"

Bits TPX com quadra de 3/8", aço-vanádio cromado, acabamento acetinado.

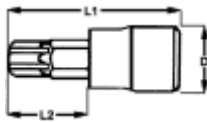

nºStock	Medida	Medida mm	L1 mm	L2 mm	D mm	Peso g	Preço
M-381210-C	TPX10	2.5	49.5	23.0	17.9	38	€ 4,10
M-381215-C	TPX15	3.0	49.5	23.0	17.9	38	€ 4,10
M-381220-C	TPX20	3.5	49.5	23.0	17.9	38	€ 4,10
M-381225-C	TPX25	4.5	49.5	23.0	17.9	38	€ 4,10
M-381227-C	TPX27	5.0	49.5	23.0	17.9	38	€ 4,10
M-381230-C	TPX30	5.5	49.5	23.0	17.9	38	€ 4,10
M-381240-C	TPX40	6.5	49.5	23.0	17.9	38	€ 4,10
M-381245-C	TPX45	7.5	49.5	23.0	17.9	38	€ 4,20
M-381250-C	TPX50	8.8	49.5	23.0	17.9	38	€ 4,20

Bits Torx 3/8"

Bits TX com quadra de 3/8", aço-vanádio cromado, acabamento acetinado.

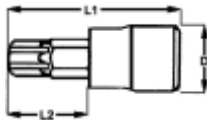

nºStock	Medida	Medida mm	L1 mm	L2 mm	D mm	Peso g	Preço
M-381210T-C	TX10	2.5	49.5	23.0	17.9	38	€ 4,10
M-381215T-C	TX15	3.0	49.5	23.0	17.9	38	€ 4,10
M-381220T-C	TX20	3.5	49.5	23.0	17.9	38	€ 4,10
M-381225T-C	TX25	4.5	49.5	23.0	17.9	38	€ 4,10
M-381227T-C	TX27	5.0	49.5	23.0	17.9	38	€ 4,10
M-381230T-C	TX30	5.5	49.5	23.0	17.9	38	€ 4,10
M-381240T-C	TX40	6.5	49.5	23.0	17.9	38	€ 4,10
M-381245T-C	TX45	7.5	49.5	23.0	17.9	38	€ 4,20
M-381250T-C	TX50	8.8	49.5	23.0	17.9	38	€ 4,20

Bits Torx 3/8"

Bits TX com quadra de 3/8", aço-vanádio cromado, acabamento acetinado.

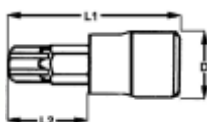

nºStock	Medida	Medida mm	L1 mm	L2 mm	D mm	Peso g	Preço
M-382210T-C	TX10	2.5	100	74	17.9	48	€ 5,90
M-382215T-C	TX15	3.0	100	74	17.9	48	€ 5,90
M-382220T-C	TX20	3.5	100	74	17.9	50	€ 5,90
M-382225T-C	TX25	4.5	100	74	17.9	50	€ 5,90
M-382227T-C	TX27	5.0	100	74	17.9	50	€ 5,90
M-382230T-C	TX30	5.5	100	74	17.9	50	€ 5,90
M-382240T-C	TX40	6.5	100	74	17.9	50	€ 5,90
M-382245T-C	TX45	7.5	100	74	17.9	65	€ 6,30
M-382250T-C	TX50	8.8	100	74	17.9	65	€ 6,30



Bits Hexagonais/Bola 3/8"

Bits hexagonais com quadra de 3/8", medida em MM, aço-vanádio cromado, acabamento acetinado.

nºStock	Medida	Med. mm	L1 mm	L2 mm	D mm	Peso g	Peso g	Preço
M-381503BL-C	HEX/BL	3.0	100	74	17.9	48	13	€ 5,20
M-381504BL-C	HEX/BL	4.0	100	74	17.9	48	13	€ 5,20
M-381505BL-C	HEX/BL	5.0	100	74	17.9	50	13	€ 5,20
M-3815055BL-C	HEX/BL	5.5	100	74	17.9	50	13	€ 5,20
M-381506BL-C	HEX/BL	6.0	100	74	17.9	50	14	€ 5,20
M-381507BL-C	HEX/BL	7.0	100	74	17.9	50	14	€ 5,70
M-381508BL-C	HEX/BL	8,0	100	74	17.9	50	14	€ 6,65
M-381510BL-C	HEX/BL	10,0	100	74	17.9	65	14	€ 6,65
M-381512BL-C	HEX/BL	12,0	100	74	17.9	65	14	€ 7,90

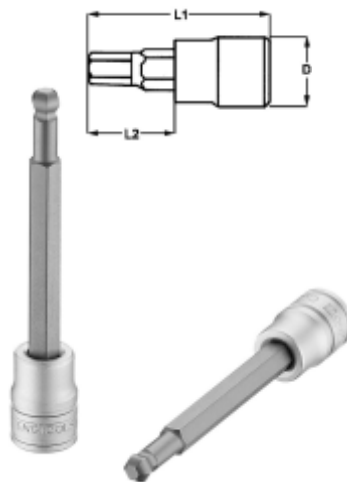
**Bits Ribe 3/8"**

Bits Ribe com quadra de 3/8", medida em MM, aço-vanádio cromado, acabamento acetinado.

nºStock	Medida	L mm	T mm	D1 mm	Peso g	Preço
M-382704-C	04	100	74	17.9	40	€ 6,30
M-382705-C	05	100	74	17.9	43	€ 6,30
M-382706-C	04	100	74	17.9	47	€ 6,30
M-382708-C	08	100	74	17.9	60	€ 8,00
M-382709-C	09	100	74	17.9	68	€ 8,00
M-382710-C	10	100	74	17.9	75	€ 8,00

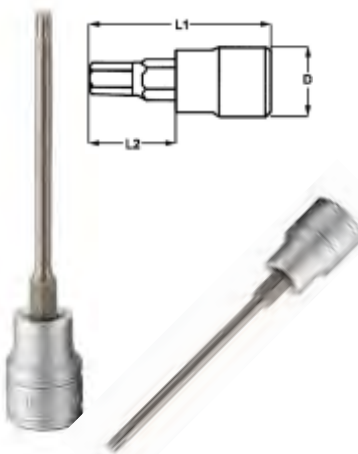
**Chaves de Bocas 3/8"**

Chaves bocas para utilizar com chaves de caixa. Aço-vanádio cromado, acabamento acetinado.

nºStock	Quadra	Medida mm	L mm	H mm	D mm	Peso g	Preço
M386510	3/8"	10	32.3	4.8	21.3	36	€ 5,80
M386511	3/8"	11	34.3	5.2	23.1	50	€ 5,80
M386512	3/8"	12	36.2	5.6	25.5	58	€ 6,70
M386513	3/8"	13	37.4	6.0	26.9	70	€ 6,70
M386514	3/8"	14	40.0	6.2	30.2	86	€ 6,70
M386515	3/8"	15	41.3	6.7	33.3	90	€ 6,70
M386516	3/8"	16	41.3	6.7	33.3	114	€ 7,45
M386517	3/8"	17	45.5	8.5	38.1	116	€ 7,45
M386518	3/8"	18	45.5	8.5	38.1	140	€ 7,50
M386519	3/8"	19	47.6	8.5	39.6	168	€ 7,55



Chaves de Caixa Longas em T 3/8"

Chaves de caixa métricas 3/8", 6 pontos, 300mm comprimento, aço-vanádio cromado, acabamento acetinado.

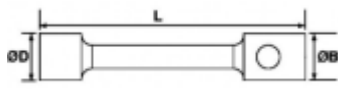

nºStock	Medida mm	Quadra	L mm	D mm	Peso g	Preço
TBSK-T07	7	3/8"	300	10	200	€ 19,30
TBSK-T08	8	3/8"	300	10	200	€ 19,50
TBSK-T10	10	3/8"	300	10	220	€ 19,50
TBSK-T12	12	3/8"	300	10	240	€ 20,00
TBSK-T13	13	3/8"	300	10	240	€ 20,00
TBSK-T14	14	3/8"	300	10	240	€ 21,00
TBSK-T17	17	3/8"	300	12	340	€ 23,00
TBSK-T19	19	3/8"	300	12	360	€ 23,00

THD01	Barra de aperto 200x80mm	€ 4,90
--------------	--------------------------	--------



TENGTTOOLS

O ROQUETE EM QUE PODES CONFIAR

FERRAMENTAS VENCEDORAS DE TESTE PARA PROFISSIONAIS

PONTO DE RUPTURA (Nm) ROQUETE 3800-72N

193% + de força comparada com as normas Internacionais

teste realizado a 27 de Maio de 2020. Min 0220Nm. ISO 6796

Vencedora!



1/2"

Roquetes 72 dentes

Roquetes 72 dentes (incrementos 8°), reversíveis, design esguio com cabo bi-materia.



n° Stock	Quadra	DIN	Descrição	Dentes	Comprimento mm	Peso g	Preço
1200-72N	1/2"	3122D	reversível c/ sis. encaixe rápido	72	250	400	€ 52,00

Roquetes articulados 72 dentes

Roquetes 72 dentes (incrementos 5°), cabeça articulada, com cabo bi-materia.



n° Stock	Quadra	Descrição	Dentes	Comprimento mm	Peso g	Preço
1200-72SN	1/2"	reversível com sistema de encaixe rápido	72	190	395	€ 49,00

Roquetes FRP

Roquetes de aço com reforço em fibra, 45 dentes (incrementos 8°), reversíveis, com sistema de encaixe rápido. cabo ergonómico bi-material.



n° Stock	Quadra	DIN	Descrição	Dentes	Torque max. Nm	Comprimento mm	Preço
1200-FRP	1/2"	3122D	reversível c/ sis. encaixe rápido	45	512	190	€ 45,00

Roquetes Longos

Roquetes de aço com reforço em fibra, 45 dentes (incrementos 8°), reversíveis, com sistema de encaixe rápido, cabo ergonómico bi-material.



n° Stock	Quadra	DIN	Descrição	Dentes	Comprimento mm	Preço
1200-45E	1/2"	3122D	Extensível rev. c/ sis. encaixe rápido	45	356-508	€ 55,00
1200-L	1/2"	3122D	reversível c/ sis. encaixe rápido	45	400	€ 38,00
1200-F	1/2"	3122D	reversível c/ sis. encaixe rápido	45	1400	€ 40,00

Extensões 1/2"



n° Stock	Quadra	Tipo	DIN	Descrição	Comprimento mm	Peso g	Preço
M-120020-C	1/2"	A	3123B	2½" extensão	63.5	105	€ 4,70
M-120021-C	1/2"	A	3123B	5" extensão	125	222	€ 6,10
M-120023-C	1/2"	A	3123B	6" extensão	150	240	€ 6,90
M-120022-C	1/2"	A	3123B	10" extensão	255	420	€ 10,50





nºStock	Quadra	Tipo	DIN	Descrição	Comprimento mm	Peso g	Preço
M-120020W-C	1/2"	B	-	3" extensão angular	75	105	€ 10,00
M-120021W-C	1/2"	B	-	6" extensão angular	150	240	€ 12,00
M-120022W-C	1/2"	B	-	10" extensão angular	255	420	€ 14,00



nºStock	Quadra	Tipo	DIN	Descrição	Comprimento mm	Peso g	Preço
M-120024-C	1/2"	C	3123B	20" extensão	500	855	€ 30,00



nºStock	Quadra	DIN	Descrição	Comprimento mm	Peso g	Preço
M-120050-C	1/2"	3122A	barra T deslizante 1/2"	243	300	€ 12,40



nºStock	Quadra	DIN	Descrição	Comprimento mm	Peso g	Preço
M-120030-C	1/2"	3123C	junta universal 1/2"	69	165	€ 14,50



nºStock	DIN	Quadra	Descrição adaptadores	Furação barra T	Comprimento mm	Peso g	Preço
M-120036-C	3123A	1/2"	1/2" fêmea:3/8" macho	Sim	39.5	55	€ 4,50
M-120037-C	3123A	1/2"	1/2" fêmea:3/4" macho	-	39.5	55	€ 6,10



nºStock	Quadra	Descrição	Comprimento mm	Peso g	Preço
M-120080-C	1/2"	adaptador articulado 1/2"	70	188	€ 16,20



nºStock	Quadra	DIN	Descrição	Comprimento mm	Peso g	Preço
M-120060-C	1/2"	3126	adaptador para bits 5/16" hexagonais	38	88	€ 6,50
M-120061-C	1/2"	3126	adaptador para bits 10mm hexagonais	38	56	€ 7,80
M-120062-C	1/2"	3126	adaptador para bits 12mm hexagonais	38	62	€ 6,50
M-120063-C	1/2"	3126	adaptador para bits 1/4" hexagonais	25	88	€ 6,50





nºStock	Quadra	DIN	Descrição	Comprimento mm	Peso g	Preço
M120010	1/2"	-	chave articulada 10,4"	265	458	€ 20,00
1201	1/2"	-	chave articulada 17"	450	894	€ 31,00
1201A	1/2"	-	chave articulada 24"	600	1198	€ 55,00



nºStock	Quadra	DIN	Descrição	Comprimento mm	Peso g	Preço
M-120011-C	1/2"	-	manivela 1/2"	420	585	€ 16,00

Chaves de Caixa 1/2"

Chaves de caixa métricas 1/2", 12 pontos, aço-vanádio cromado, acabamento acetinado. DIN 3120/3124, ISO 2725.

nºStock	Medida mm	L mm	T mm	D1 mm	D2 mm	Peso g	Preço
M-120508-C	8	38.0	9.0	13.0	21.8	43	€ 3,30
M-120509-C	9	38.0	10.0	14.5	21.8	45	€ 3,30
M-120510-C	10	38.0	10.0	15.5	21.8	47	€ 3,30
M-120511-C	11	38.0	10.0	16.7	21.8	49	€ 3,30
M-120512-C	12	38.0	10.0	18.0	21.8	51	€ 3,30
M-120513-C	13	38.0	10.0	19.2	21.8	52	€ 3,30
M-120514-C	14	38.0	10.0	20.5	21.8	52	€ 3,30
M-120515-C	15	38.0	14.0	21.0	21.8	53	€ 3,30
M-120516-C	16	38.0	14.3	22.5	23.3	62	€ 3,45
M-120517-C	17	38.0	15.3	24.2	23.0	80	€ 3,75
M-120518-C	18	38.0	16.7	24.7	23.0	82	€ 4,00
M-120519-C	19	38.0	17.3	26.3	24.0	88	€ 4,40
M-120520-C	20	38.0	18.0	27.0	23.7	96	€ 4,80
M-120521-C	21	38.0	18.0	28.0	24.0	104	€ 4,80
M-120522-C	22	40.0	18.0	29.8	26.0	113	€ 5,00
M-120523-C	23	40.0	18.0	30.8	27.0	120	€ 5,20
M-120524-C	24	40.0	20.0	31.8	26.0	126	€ 5,40
M-120525-C	25	40.0	20.0	33.4	28.0	136	€ 5,60
M-120526-C	26	40.0	20.0	34.8	29.0	140	€ 6,00
M-120527-C	27	43.0	20.0	35.8	30.0	166	€ 6,40
M-120528-C	28	43.0	20.0	37.8	31.0	172	€ 6,70
M-120529-C	29	43.0	20.0	38.8	32.0	180	€ 6,90
M-120530-C	30	43.0	22.0	39.8	33.0	191	€ 7,00
M-120532-C	32	43.0	23.0	41.8	35.0	212	€ 7,50
M-120534-C	34	45.5	23.0	43.8	36.0	223	€ 10,60

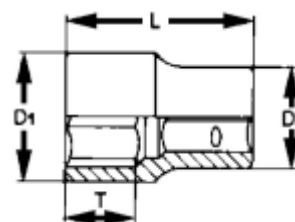

Chaves de Caixa 1/2"

Chaves de caixa métricas 1/2", 6 pontos, aço-vanádio cromado, acabamento acetinado. DIN 3120/3124, ISO 2725.

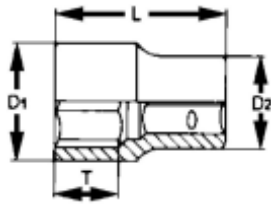

nºStock	Medida mm	L mm	T mm	D1 mm	D2 mm	Peso g	Preço
M-1205106-C	10	38.0	10.0	15.5	21.8	47	€ 3,30
M-1205116-C	11	38.0	10.0	16.7	21.8	49	€ 3,30
M-1205126-C	12	38.0	10.0	18.0	21.8	51	€ 3,30
M-1205136-C	13	38.0	10.0	19.2	21.8	52	€ 3,30
M-1205146-C	14	38.0	10.0	20.5	21.8	52	€ 3,30
M-1205156-C	15	38.0	14.0	21.0	21.8	53	€ 3,30
M-1205166-C	16	38.0	14.3	22.5	23.3	62	€ 3,45
M-1205176-C	17	38.0	14.3	24.2	23.0	80	€ 3,75
M-1205186-C	18	38.0	15.3	24.7	23.0	82	€ 4,00
M-1205196-C	19	38.0	16.7	26.3	24.0	88	€ 4,40
M-1205206-C	20	38.0	17.3	27.0	24.0	96	€ 4,80
M-1205216-C	21	38.0	18.0	28.0	24.0	104	€ 4,80
M-1205226-C	22	40.0	18.0	29.8	26.0	113	€ 5,00
M-1205236-C	23	40.0	18.0	30.8	27.0	120	€ 5,20
M-1205246-C	24	40.0	18.0	31.8	26.0	126	€ 5,40
M-1205256-C	25	40.0	20.0	33.4	28.0	136	€ 5,60
M-1205266-C	26	40.0	20.0	34.8	29.0	140	€ 6,00
M-1205276-C	27	43.0	20.0	35.8	30.0	166	€ 6,40
M-1205286-C	28	43.0	20.0	37.8	31.0	172	€ 6,70
M-1205296-C	29	43.0	20.0	38.8	32.0	180	€ 6,90
M-1205306-C	30	43.0	20.0	39.8	33.0	191	€ 7,00
M-1205326-C	32	43.0	22.0	41.8	35.0	222	€ 7,50
M-1205336-C	33	45.5	23.5	42.8	35.0	235	€ 9,50
M-1205346-C	34	45.5	23.5	43.8	36.0	254	€ 10,60

Chaves de Caixa Longas 1/2"

Chaves de caixa métricas 1/2", 6 pontos, aço-vanádio cromado, acabamento acetinado. DIN 3120/3124, ISO 2725.



nºStock	Medida mm	L mm	T mm	D1 mm	D2 mm	Peso g	Preço
M-1206136-C	13	79.0	21.0	19.2	22.0	135	€ 7,35
M-1206146-C	14	79.0	25.0	20.5	22.0	135	€ 7,60
M-1206156-C	15	79.0	28.0	21.5	22.0	135	€ 7,60
M-1206166-C	16	79.0	31.0	22.5	23.3	150	€ 7,60
M-1206176-C	17	79.0	34.0	24.2	24.2	155	€ 7,70
M-1206186-C	18	79.0	34.0	25.4	25.4	165	€ 7,70
M-1206196-C	19	79.0	34.0	26.7	26.7	190	€ 7,70
M-1206246-C	24	79.0	34.0	31.8	31.8	240	€ 8,40



Chaves de Caixa Longas 1/2"

Chaves de caixa métricas 1/2", 12 pontos, aço-vanádio cromado, acabamento acetinado. DIN 3120/3124, ISO 2725.

nºStock	Medida	L mm	T mm	D1 mm	D2 mm	Peso g	Preço
M-120610-C	10	79.0	17.0	15.5	22.0	125	€ 7,20
M-120611-C	11	79.0	18.0	16.7	22.0	130	€ 7,20
M-120612-C	12	79.0	19.0	18.0	22.0	130	€ 7,35
M-120613-C	13	79.0	21.0	19.2	22.0	135	€ 7,35
M-120614-C	14	79.0	25.0	20.5	22.0	135	€ 7,60
M-120615-C	15	79.0	28.0	21.5	22.0	135	€ 7,60
M-120616-C	16	79.0	31.0	22.5	23.3	150	€ 7,60
M-120617-C	17	79.0	24.0	24.2	24.2	155	€ 7,70
M-120618-C	18	79.0	34.0	25.4	25.4	165	€ 7,70
M-120619-C	19	79.0	34.0	26.7	26.7	190	€ 7,70
M-120620-C	20	79.0	34.0	27.8	27.8	195	€ 7,70
M-120621-C	21	79.0	34.0	27.8	27.8	200	€ 7,90
M-120622-C	22	79.0	34.0	29.8	29.8	230	€ 7,90
M-120624-C	24	79.0	34.0	31.8	28.5	240	€ 8,40
M-120627-C	27	79.0	34.0	35.8	32.0	280	€ 12,50
M-120630-C	30	79.0	34.0	39.8	35.0	360	€ 14,20
M-120632-C	32	79.0	34.0	41.3	36.5	380	€ 15,50
M-120636-C	36	79.0	34.0	46.0	41.0	390	€ 18,15

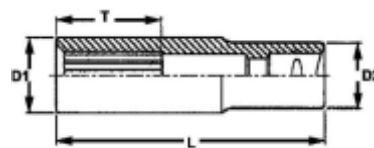

Chaves de Caixa 1/2"

Chaves de caixa 1/2", medida em polegadas, 12 pontos, aço-vanádio cromado, acabamento acetinado. DIN 3120/3124, ISO 2725.

nºStock	Medida	L mm	T mm	D1 mm	D2 mm	Peso g	Preço
M-120112-C	3/8"	38.0	9.0	14.7	21.8	46	€ 3,30
M-120114-C	7/16"	38.0	9.0	17.0	21.8	50	€ 3,30
M-120116-C	1/2"	38.0	10.0	19.0	21.8	52	€ 3,30
M-120118-C	9/16"	38.0	12.5	20.8	21.8	55	€ 3,30
M-120119-C	19/32"	38.0	12.5	20.8	21.8	55	€ 3,30
M-120120-C	5/8"	38.0	14.3	23.3	22.5	62	€ 3,30
M-120122-C	11/16"	38.0	14.3	24.7	23.0	72	€ 3,40
M-120124-C	25/32"	38.0	20.0	26.3	24.0	76	€ 4,30
M-120125-C	9/16"	38.0	12.5	20.8	21.8	55	€ 4,40
M-120126-C	13/16"	38.0	20.0	28.8	24.0	80	€ 4,60
M-120128-C	7/8"	40.0	21.0	29.8	26.0	95	€ 5,00
M-120130-C	15/16"	40.0	21.0	31.8	26.0	110	€ 5,40
M-120132-C	1"	43.0	21.0	33.4	27.3	120	€ 6,00
M-120134-C	1 1/16"	43.0	23.0	35.8	28.7	145	€ 6,40
M-120136-C	1 1/8"	43.0	23.0	37.8	31.0	150	€ 6,75
M-120138-C	1 3/16"	43.0	23.0	39.8	33.0	190	€ 7,00
M-120140-C	1 1/4"	43.0	23.0	41.8	34.0	205	€ 7,40

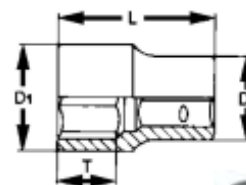

Bits Hexagonais 1/2"

Bits hexagonais com quadra de 1/2", aço-vanádio cromado, acabamento acetinado. DIN 7422.

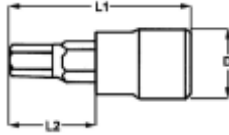

nºStock	Medida mm	L1 mm	L2 mm	D mm	Peso g	Preço
M-121505-C	5	55.0	20.5	22.0	52	€ 4,50
M-121506-C	6	55.0	20.5	22.0	54	€ 4,50
M-121507-C	7	55.0	20.5	22.0	60	€ 4,50
M-121508-C	8	55.0	20.5	22.0	62	€ 4,50
M-121509-C	9	55.0	20.5	22.0	66	€ 4,50
M-121510-C	10	55.0	20.5	22.0	72	€ 4,90
M-121512-C	12	55.0	20.5	22.0	80	€ 5,80
M-121514-C	14	55.0	20.5	22.0	96	€ 7,00
M-121515-C	15	55.0	20.5	22.0	96	€ 7,20
M-121516-C	16	55.0	20.5	22.0	96	€ 7,70
M-121517-C	17	55.0	20.5	25.0	154	€ 8,20
M-121518-C	18	55.0	20.5	22.0	172	€ 8,30
M-121519-C	19	60.0	23.0	25.9	182	€ 8,50

Bits Hexagonais 1/2"

Bits hexagonais com quadra de 1/2", medida em polegadas, aço-vanádio cromado, acabamento acetinado. DIN 7422.

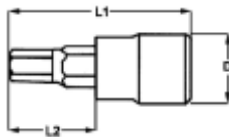

nºStock	Medida	L1 mm	L2 mm	D mm	Peso g	Preço
M-121106-C	3/16"	55.0	20.0	22.0	55	€4,30
M-121107-C	7/32"	55.0	20.0	22.0	55	€ 4,30
M-121108-C	1/4"	55.0	20.0	22.0	55	€ 4,30
M-121109-C	9/32"	55.0	20.0	22.0	60	€ 4,50
M-121110-C	5/16"	55.0	20.0	22.0	62	€ 4,50
M-121112-C	3/8"	55.0	20.0	22.0	67	€ 4,60
M-121116-C	1/2"	55.0	20.0	22.0	85	€ 5,40
M-121118-C	9/16"	55.0	20.0	22.0	100	€ 6,70
M-121120-C	5/8"	55.0	20.0	22.0	120	€ 7,90

Bits Longos Hexagonais 1/2"

Bits hexagonais com quadra de 1/2", aço-vanádio cromado, acabamento acetinado. DIN 7422.

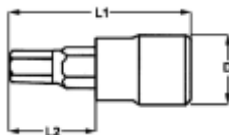

nºStock	Medida mm	L1 mm	L2 mm	D mm	Peso g	Preço
M-122505-C	5	100.0	65.5	22.0	60	€ 6,70
M-122506-C	6	100.0	65.5	22.0	60	€ 6,70
M-122507-C	7	100.0	65.5	22.0	80	€ 6,70
M-122508-C	8	100.0	65.5	22.0	80	€ 6,70
M-122510-C	10	100.0	65.5	22.0	100	€ 7,20
M-122512-C	12	100.0	65.5	22.0	120	€ 8,70
M-122514-C	14	100.0	65.5	22.0	153	€ 9,20
M-122517-C	17	100.0	65.5	25.0	225	€ 12,50



Bits Extra Longos Hexagonais 1/2"

Bits hexagonais com quadra de 1/2", aço-vanádio cromado, acabamento acetinado. DIN 7422.

nºStock	Medida mm	L1 mm	L2 mm	D mm	Peso g	Preço
M-122506A-C	6	115	80	22	100	€ 6,80
M-122508A-C	8	115	80	22	120	€ 6,80
M-122510L-C	10	175	140	22	150	€ 7,80

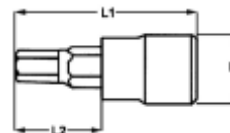
**Bits Longos XZN 1/2"**

Bits XZN com quadra de 1/2", aço-vanádio cromado, acabamento acetinado.

nºStock	Medida	L1 mm	L2 mm	D mm	Peso g	Preço
M-122805-C	05	100	65.0	22.0	70	€ 6,40
M-122806-C	06	100	65.0	22.0	70	€ 6,40
M-122808-C	08	100	65.0	22.0	70	€ 6,40
M-122809-C	09	100	65.0	22.0	70	€ 8,15
M-122810-C	10	100	65.0	22.0	90	€ 8,15
M-122812-C	12	100	65.0	22.0	110	€ 9,50
M1-22814-C	14	100	65.0	22.0	130	€ 10,90
M-122816-C	16	100	65.0	22.0	160	€ 13,50

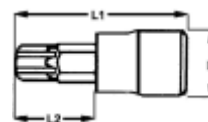
**Bits Longos Ribe 1/2"**

Bits Ribe com quadra de 1/2", aço-vanádio cromado, acabamento acetinado.

nºStock	Medida	L1 mm	L2 mm	D mm	Peso g	Preço
M-122704-C	04	100	65.0	22.0	70	€ 6,10
M-122705-C	05	100	65.0	22.0	70	€ 6,10
M-122706-C	06	100	65.0	22.0	70	€ 6,10
M-122708-C	08	100	65.0	22.0	70	€ 6,10
M-122709-C	09	100	65.0	22.0	70	€ 7,95
M-122710-C	10	100	65.0	22.0	90	€ 8,00
M-122711-C	11	100	65.0	22.0	100	€ 9,60
M-122712-C	12	100	65.0	22.0	110	€ 10,50
M-122713-C	13	100	65.0	22.0	120	€ 11,30

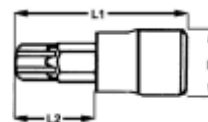

Bits Torx com Furo 1/2"

Bits TPX com quadra de 1/2", aço-vanádio cromado, acabamento acetinado.

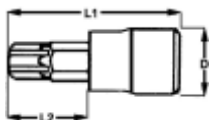

nºStock	Medida	Medida mm	L1 mm	L2 mm	D mm	Peso g	Preço
M-121220-C	TPX20	3.5	55.0	20.5	22.0	60	€ 4,80
M-121225-C	TPX25	4.5	55.0	20.5	22.0	60	€ 4,80
M-121227-C	TPX27	5.0	55.0	20.5	22.0	60	€ 4,80
M-121230-C	TPX30	5.5	55.0	20.5	22.0	60	€ 4,80
M-121240-C	TPX40	6.5	55.0	20.5	22.0	68	€ 4,80
M-121245-C	TPX45	7.5	55.0	20.5	22.0	68	€ 5,20
M-121250-C	TPX50	8.8	55.0	20.5	22.0	68	€ 5,20
M-121255-C	TPX55	11.1	55.0	20.5	22.0	68	€ 5,70
M-121260-C	TPX60	13.1	55.0	20.5	22.0	68	€ 6,40

Bits Torx 1/2"

Bits TX com quadra de 1/2", aço-vanádio cromado, acabamento acetinado.

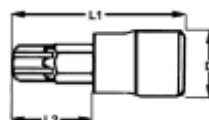

nºStock	Medida	Medida mm	L1 mm	L2 mm	D mm	Peso g	Preço
M-121220T-C	TX20	3.5	55.0	20.5	22.0	60	€ 4,80
M-121225T-C	TX25	4.5	55.0	20.5	22.0	60	€ 4,80
M-121227T-C	TX27	5.0	55.0	20.5	22.0	60	€ 4,80
M-121230T-C	TX30	5.5	55.0	20.5	22.0	60	€ 4,80
M-121240T-C	TX40	6.5	55.0	20.5	22.0	60	€ 4,80
M-121245T-C	TX45	7.5	55.0	20.5	22.0	68	€ 5,20
M-121250T-C	TX50	8.8	55.0	20.5	22.0	68	€ 5,20
M-121255T-C	TX55	11.1	55.0	20.5	22.0	68	€ 5,70
M-121260T-C	TX60	13.1	55.0	20.5	22.0	68	€ 6,70

Bits Longos Torx 1/2"

Bits TX com quadra de 1/2", aço-vanádio cromado, acabamento acetinado.

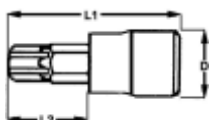

nºStock	Medida	Medida mm	L1 mm	L2 mm	D mm	Peso g	Preço
M-122220T-C	TX20	3.5	100.0	65.5	22.0	60	€ 6,90
M-122225T-C	TX25	4.5	100.0	65.5	22.0	60	€ 6,90
M-122227T-C	TX27	5.0	100.0	65.5	22.0	60	€ 6,90
M-122230T-C	TX30	5.5	100.0	65.5	22.0	60	€ 6,90
M-122240T-C	TX40	6.5	100.0	65.5	22.0	60	€ 6,90
M-122245T-C	TX45	7.5	100.0	65.5	22.0	80	€ 7,40
M-122250T-C	TX50	8.8	100.0	65.5	22.0	100	€ 7,40
M-122255T-C	TX55	11.1	100.0	65.5	22.0	100	€ 8,60
M-122260T-C	TX60	13.1	100.0	65.5	22.0	100	€ 9,30
M-122270T-C	TX70	15.5	100.0	65.5	22.0	100	€ 9,30

Chaves de Caixa TX-E 1/2"

Chaves de caixa 1/2", aço-vanádio cromado, acabamento acetinado.

nºStock	Medida	Medida mm	L mm	T mm	D1 mm	D2 mm	Peso g	Preço
M-120710-C	E10	9.42	37.8	9.5	13.1	23.5	39	€ 4,30
M-120711-C	E11	10.08	37.8	9.5	14.1	23.5	42	€ 4,30
M-120712-C	E12	11.17	37.8	9.5	14.9	23.5	43	€ 4,30
M-120714-C	E14	12.90	37.8	12.3	16.7	23.5	44	€ 4,30
M-120716-C	E16	14.76	37.8	13.0	19.1	23.5	49	€ 4,30
M-120718-C	E18	16.70	37.8	13.0	20.9	23.5	52	€ 5,70
M-120720-C	E20	18.45	37.8	13.0	23.7	23.5	60	€ 5,80
M-120722-C	E22	20.30	37.8	16.1	26.1	26.1	82	€ 5,80
M-120724-C	E24	22.16	37.8	16.4	28.0	28.0	102	€ 5,90

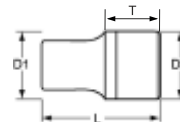

3/4"

Roquetes industriais 72 dentes

Roquetes industriais 72 dentes (incrementos 5°), reversíveis, com sistema de encaixe rápido.

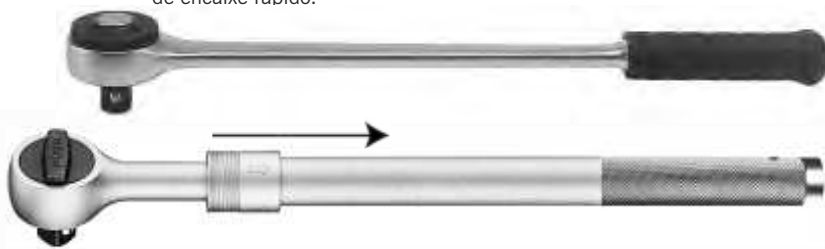

nº Stock	Quadra	Descrição	Dentes	Comprimento mm	Peso g	Preço
M-3400-72	3/4"	reversível com sistema de encaixe rápido	72	505	2000	€ 135,00
M-3400-72E	3/4"	Extensível rev. c/ sis. encaixe rápido	72	545-860	3372	€ 180,00

MECANISMO DE SEGURANÇA TENG TOOLS

As chaves de caixa de 3/4" podem ser pesadas e, se soltarem do roquete ou de uma extensão ou acessório, podem ser um risco para a saúde e a segurança. Para reduzir a probabilidade de isso acontecer, a Teng Tools introduziu uma série de extensões de 3/4", uma barra T deslizante e uma junta universal com mecanismo de segurança. Este mecanismo consiste de um design simples que trava a chave na quadra para evitar que a chave se solte devido ao seu peso.



Extensões 3/4"



nºStock	Quadra	Tipo	DIN	Descrição	Comprimento mm	Peso g	Preço
M-340020-C	3/4"	A	3123B	4" extensão	100	400	€ 17,00
M-340020S-C	3/4"	A	3123B	4" extensão com mecanismo de segurança	100	450	€ 28,20
M-340021-C	3/4"	A	3123B	8" extensão	200	700	€ 21,00
M-340021S-C	3/4"	A	3123B	8" extensão com mecanismo de segurança	200	750	€ 32,00
M-340022-C	3/4"	A	3123B	16" extensão	400	1400	€ 34,00
M-340022S-C	3/4"	A	3123B	16" extensão com mecanismo de segurança	400	1400	€ 48,00





nºStock	Quadra	DIN	Descrição	Comprimento mm	Peso g	Preço
M-340050-C	3/4"	3122A	barra T deslizante 3/4"	450	450	€ 35,00
M-340050S-C	3/4"	3122A	barra T deslizante 3/4" com mecanismo de segurança	450	450	€ 41,00



nºStock	Quadra	DIN	Descrição	Comprimento mm	Peso g	Preço
M-340030-C	3/4"	3123C	junta universal 3/4"	108	570	€ 46,50

nºStock	DIN	Quadra	Descrição Adaptadores	Furação barra T	Comprimento mm	Peso g	Preço
M-340085-C	-	3/4"	3/4" fêmea:1" macho	-	62.0	370	€ 20,00
M-340086-C	3123A	3/4"	3/4" fêmea:1/2" macho	-	40.0	52	€ 7,60



nºStock	Quadra	DIN	Descrição	Comprimento mm	Peso g	Preço
M-340070-C	3/4"	3122F	chave articulada 17"	480	1880	€ 44,00
M-340070S-C	3/4"	3122F	chave articulada 19" com mecanismo de segurança	480	1880	€ 50,00
3401	3/4"	3122F	chave articulada 39" com mecanismo de segurança	990	2300	€ 161,00

Bits Hexagonais 3/4"

Bits hexagonais com quadra de 3/4", aço-vanádio cromado, acabamento acetinado.

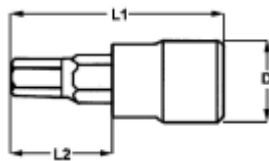

nºStock	Medida mm	L1 mm	L2 mm	D mm	Peso g	Preço
M-341514-C	14	78.5	25	36	326	€ 24,00
M-341517-C	17	78.5	25	36	330	€ 24,00
M-341519-C	19	78.5	25	36	334	€ 24,00
M-341522-C	22	78.5	25	36	338	€ 24,00



Chaves de Caixa 3/4"

Chaves de caixa métricas 3/4", 6 pontos, aço-vanádio cromado, acabamento acetinado. DIN 3120/3124, ISO 2725.

nºStock	Medida mm	L mm	T mm	D1 mm	D2 mm	Peso g	Preço
M-3405196-C	19	50.0	14	29.2	33	180	€ 10,60
M-3405216-C	21	50.0	14	31.2	33	180	€ 10,60
M-3405226-C	22	50.0	14	32.2	36	220	€ 10,60
M-3405246-C	24	51.0	16	34.2	36	230	€ 10,60
M-3405266-C	26	52.0	18	36.0	36	240	€ 10,60
M-3405276-C	27	52.0	22	38.0	36	240	€ 11,50
M-3405306-C	30	54.0	24	42.0	38	260	€ 11,90
M-3405326-C	32	56.0	26	44.0	38	310	€ 12,30
M-3405336-C	33	56.0	26	46.0	38	330	€ 12,30
M-3405346-C	34	56.0	26	47.0	38	350	€ 13,50
M-3405366-C	36	58.0	28	50.0	38	430	€ 14,20
M-3405386-C	38	60.0	28	52.0	42	500	€ 14,90
M-3405416-C	41	64.0	30	56.0	45	570	€ 17,20
M-3405466-C	46	68.0	34	62.0	45	690	€ 19,90
M-3405506-C	50	72.0	36	68.0	48	830	€ 22,80

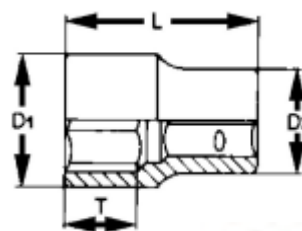

Chaves de Caixa 3/4"

Chaves de caixa 3/4", medida em polegadas, 12 pontos, aço-vanádio cromado, acabamento acetinado. DIN 3120/3124.

nºStock	Medida	L mm	T mm	D1 mm	D2 mm	Peso g	Preço
M-340124-C	3/4"	50.0	14.0	29.2	33.0	180	€ 10,50
M-340128-C	7/8"	51.0	18.1	32.2	36.2	195	€ 10,50
M-340130-C	15/16"	51.0	18.1	34.5	36.2	200	€ 10,50
M-340132-C	1"	51.0	24.0	37.0	37.0	200	€ 10,50
M-340134-C	1 1/16"	51.0	24.0	38.3	37.0	200	€ 11,00
M-340136-C	1 1/8"	51.0	24.3	40.0	38.5	230	€ 11,50
M-340138-C	1 3/16"	53.0	25.2	42.0	38.5	255	€ 11,60
M-340140-C	1 1/4"	55.0	28.0	44.0	38.5	275	€ 12,10
M-340142-C	1 5/16"	55.0	28.0	46.0	38.5	300	€ 12,30
M-340144-C	1 3/8"	57.0	29.7	48.0	42.3	360	€ 13,20
M-340146-C	1 7/16"	57.0	29.7	50.0	42.3	380	€ 13,90
M-340148-C	1 1/2"	60.0	31.1	52.1	45.2	440	€ 14,40
M-340152-C	1 5/8"	63.0	33.7	56.1	45.2	515	€ 16,20
M-340156-C	1 3/4"	65.0	33.7	60.0	48.0	610	€ 18,30
M-340158-C	1 9/16"	67.0	35.7	62.0	48.0	635	€ 19,50
M-340160-C	1 7/8"	69.0	37.2	64.0	48.3	690	€ 20,50
M-340164-C	2"	71.0	38.6	68.2	48.3	755	€ 21,50

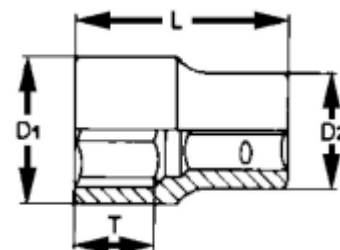

1"

Roquetes industriais 72 dentes

Roquetes industriais 72 dentes (incrementos 5°), reversíveis, com sistema de encaixe rápido.



nº Stock	Quadra	Descrição	Dentes	Comprimento mm	Peso g	Preço
M-1100-72	1"	reversível com sistema de encaixe rápido	72	800	4000	€ 225,00

Roquetes industriais 1"

Roquetes industriais 24 dentes, cabeça destacável, reversíveis, com sistema de encaixe rápido.



nº Stock	Quadra	DIN	Descrição	Dentes	Comprimento mm	Peso g	Preço
M-1100	1"	3122D	roquete com cabeça destacável	24	665	4410	€ 149,00
M-110010	1"	3122D	cabeça de roquete	24	165	1740	€ 111,00
M-110020	1"	-	cabo 22" para uso com M110010	-	560	2670	€ 41,00



nº Stock	Quadra	DIN	Descrição	Comprimento mm	Peso g	Preço
1101	1"	3122F	chave articulada 39" com mecanismo de segurança	990	2300	€ 171,00



nº Stock	Quadra	DIN	Descrição	Comprimento mm	Peso g	Preço
M110070	1"	-	chave articulada 25"	650	3550	€ 130,00



nº Stock	Quadra	Tipo	DIN	Descrição	Comprimento mm	Peso g	Preço
M110040	1"	A	3123B	8" extensão	200	1350	€ 43,00
M110050	1"	A	3123B	16" extensão	400	2400	€ 70,00

M110030	-	1"	adaptador barra T 1"	-	82.0	620	€ 31,50
----------------	---	----	----------------------	---	------	-----	---------



Chaves de Caixa 1"

Chaves de caixa métricas 1", 12 pontos, aço-vanádio cromado, acabamento acetinado.

nºStock	Medida mm	L mm	T mm	D1 mm	D2 mm	Peso g	Preço
M-110536	36	65.3	31.2	51.0	45.2	440	€ 20,70
M-110541	41	70.2	33.8	57.1	45.2	550	€ 23,00
M-110546	46	74.5	37.5	64.6	49.4	810	€ 27,00
M-110550	50	75.3	38.1	69.9	55.2	995	€ 32,00
M-110555	55	80.0	40.0	76.2	57.3	1160	€ 37,00
M-110558	58	80.0	40.0	79.2	57.3	1250	€ 41,00
M-110560	60	84.0	41.0	82.1	57.3	1410	€ 44,00
M-110565	65	87.3	46.2	88.0	57.3	1540	€ 51,00
M-110570	70	93.4	51.5	94.0	68.1	2020	€ 60,00
M-110575	75	96.1	51.5	94.0	68.1	2020	€ 68,00
M-110580	80	103.6	55.3	105.0	68.1	2500	€ 77,00

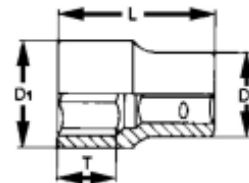
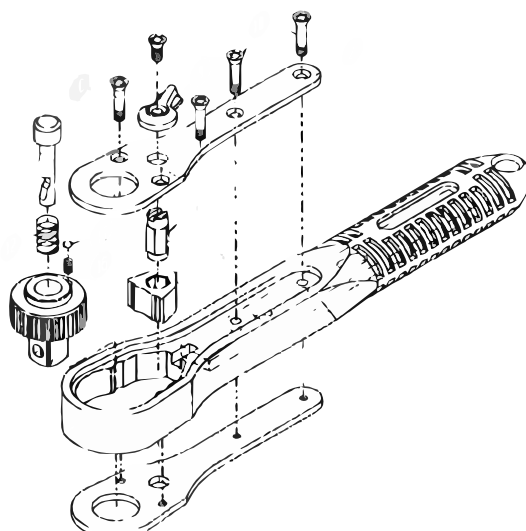
Kits de reparação -
Preços sob consulta prévia

Adaptadores magnéticos

MX-04 | € 79,00

Conjunto de adaptadores magnéticos. Ideais para uso em espaços restritos.



Adaptadores 1/4"F:3/8"M, 3/8"F:1/2"M, 1/2"F:3/4"M, 3/4"F:1"M

nºStock	Quadra interna	Quadra externa	Profundidade mm	Comprimento mm	Altura mm	Peso g	Preço
M-140036M	1/4"	3/8"	28	28	15	18	€ 12,50
M-380036M	3/8"	1/2"	30	30	20	30	€ 18,50
M-120037M	1/2"	3/4"	45	45	30	86	€ 24,30
M-140085M	3/4"	1"	54	54	35	130	€ 30,00



5/16"

ID-506BIT | € 2,80

Jogo 4 bits impacto 5/16".

Bits 5/16" fenda 8x36 e 10x36mm, PH2, PH3

**ID-515BIT | € 6,70**

Jogo 12 bits impacto 5/16".

Bits 5/16" fenda 6x36, 8x36, 10x36, 12x36mm, PH1, PH2, PH3, PH4, hex 4, 5, 6, 8mm



nºStock	Quadra	Descrição	Comp. mm	Preço
910504	5/16" hex	4mm hex	36.0	€ 0,90
910505	5/16" hex	5mm hex	36.0	€ 0,90
910506	5/16" hex	6mm hex	36.0	€ 0,90
910508	5/16" hex	8mm hex	36.0	€ 0,90
910510	5/16" hex	10mm hex	36.0	€ 1,30
920001	5/16" hex	PZ1	36.0	€ 1,00
920002	5/16" hex	PZ2	36.0	€ 1,00
920003	5/16" hex	PZ3	36.0	€ 1,00

ID-506 | € 28,20

Chave de impacto reversível com quadra de 1/2", inclui adaptador para bits 5/16" e 4 bits .Fornecido em caixa ABS. (265x142x50mm, 1.3kg).

Acessórios 1/2" chave de impacto reversível, adaptador para bits 5/16"

Bits 5/16" fenda 8x36 e 10x36mm, PH2, PH3

**ID-515 | € 25,00**

Chave de impacto reversível com quadra de 1/2", inclui adaptador para bits 5/16" e 12 bits .Fornecido em caixa ABS. (223x115x52mm, 1.0kg)

Acessórios 1/2" chave de impacto reversível, adaptador para bits 5/16", adaptador 5/16" hex x 3/8"M

Bits 5/16" fenda 6x36, 8x36, 10x36, 12x36mm, PH1, PH2, PH3, PH4, hex 4, 5, 6, 8mm



nºStock	Quadra	Descrição	Comp. mm	Preço
940006	5/16" hex	6mm fenda	36.0	€ 0,90
940008	5/16" hex	8mm fenda	36.0	€ 0,90
940010	5/16" hex	10mm fenda	36.0	€ 1,45
940012	5/16" hex	12mm fenda	36.0	€ 2,10
930001	5/16" hex	PH1	36.0	€ 0,90
930002	5/16" hex	PH2	36.0	€ 0,90
930003	5/16" hex	PH3	36.0	€ 0,90
930004	5/16" hex	PH4	36.0	€ 0,90
970030	5/16" hex	TX30	36.0	€ 0,95
970040	5/16" hex	TX40	36.0	€ 0,95
970045	5/16" hex	TX45	36.0	€ 0,95
970050	5/16" hex	TX50	36.0	€ 0,95
970055	5/16" hex	TX55	36.0	€ 1,60



1/4"

TJ-1412 | € 22,00
 Jogo bolso impacto 1/4" 12pcs



Contém: TXP3003001, ROBP3000101, TXP3002501, TXP3001001, PHP3000201, MBHI14, PZP3000101, PZP3000201, GRP3000201, ROBP3000201, TXP3002001PZ

TJ-1413 | € 22,00
 Jogo bolso impacto 1/4" 13pcs



Contém: TXP3003001, ROBP3000101, HEXP3000501, HEXP3000301, TXP3002501, HEXP3000401, MBHI14, PZP3000101, PZP3000201, GRP3000201, ROBP3000201, TXP3002001

TJ-1414 | € 21,00
 Jogo bolso impacto 1/4" 20pcs



Contém: TXP3003001, TXP3002501, TXP3001001, TXP3002701, TXP3004001, MBHI14, TXP3002001, TXP3001501



TJ-1430 | € 43,00
 Jogo bolso 1/4" impacto 30pcs



Contém: TXP3003001, HEXP3000601, ROBP3000101, HEXP3000501, HEXP3000301, TXP3002501, TXP3001001, TXP3002701, PHP3000201, HEXP3000401, TXP3004001, PHP3000301, MBHI14, PZP3000101, PZP3000201, QCI14, PHP3000101, GRP3000201, ROBP3000201, TXP3002001, TXP3001501, PZP3000301

TJ-NS05 | € 29,00
 Jogo bolso 1/4" impacto 5pcs



Contém: NSP65108, NSP65507, NSP65508, NSP65510, NSP65513.

TM-010 | € 21,00
 Jogo bits de impacto, 10 peças.



Aces	1/4" encabadoiro magnético 60mm
Bits	1/4" fenda 6x36, 8x36, 10x36, 12x36mm, PH1, PH2, PH3, PH4, hex 4, 5, 6, 8mm

Contém: TXP3003001, ROBP3000101, HEXP3000501, TXP3002501, HEXP3000401, MBHI14, PZP3000201, GRP3000201, ROBP3000201, TXP3002001

TMC-010 | € 20,00
 Jogo bits de impacto, 10 peças.



Aces	1/4" encabadoiro magnético 60mm
Bits	1/4" PZ1, PZ2, PZ3, PH2, GR2, TX10, hex TX20, TX25, TX30

Contém: TXP3003001, TXP3002501, TXP3001001, PHP3000201, MBHI14, PZP3000101, PZP3000201, GRP3000201, TXP3002001, PZP3000301

TM-TX10 | € 20,00
 Jogo bits de impacto Torx, 10 peças.



Aces	1/4" encabadoiro magnético 60mm
Bits	1/4" TX10, TX15, TX20 (x2), TX25 (x2), hex TX27, TX30, TX40

Contém: TXP3003001, TXP3002501, TXP3001001, TXP3002701, TXP3004001, MBHI14, TXP3002001, TXP3001501



TB-NSI5 | € 33,00

Jogo bits de caixa impacto, aço S2 dureza HRC50-60, com ponta magnética.



Bits	1/4" 1/4", 7, 8, 10, 13mm
------	---------------------------

Contém:	NSP65507, NSP65508, NSP65108, NSP65513, NSP65510
---------	--

TB-BSI27 | € 46,00

Jogo bits de impacto, 27 peças.



Acess	1/4" hex encabadouro magnético 60mm, adaptador
-------	--

Bits 30mm	1/4" hex PH1, PH2, PH3, PZ1, PZ2, PZ3, GR2, GR3, GR4, GR5, hex 6mm, TX10, TX15, TX20, TX25, TX40
-----------	--

Bits	1/4" hex TX25, TX30, ROB1, 2, 3
------	---------------------------------

Bits	1/4" hex 1/4", 7, 8, 10mm
------	---------------------------

Contém:	HEXP3000401, ROBP8900101, PHP3000201, NSP65108, ROBP8900201, NSP65508, TXP3001001, TXP3002501, HEXP3000301, HEXP3000501, PZP3000301, HEXP3000601, TXP8902501, NSP65507, PHP3000301, TXP3004001, MBHI14, PZP3000101, PZP3000201, PHP3000101, GRP3000201, TXP3002001, NSP65510, TXP8903001, TXP3001501, ACCSDA1414, ROBP8900301
---------	---

TH-BSI22 | € 26,50

Jogo bits de impacto, 22 peças.



Acess	1/4" hex encabadouro magnético 60mm, adaptador
-------	--

Bits 25mm	PH1, PH2, PH3, PZ1, PZ2, PZ3, GR2, GR3, GR4, GR5, 1/4" hex hex 6mm, TX10, TX15, TX20, TX25, TX30, TX40, ROB 1, 2, 3
-----------	---

Contém:	TXP3003001, HEXP3000601, ROBP3000101, HEXP3000501, HEXP3000301, TXP3002501, TXP3001001, PHP3000201, HEXP3000401, TXP3004001, PHP3000301, ACCSDA1414, MBHI14, PZP3000101, PZP3000201, PHP3000101, GRP3000201, ROBP3000201, TXP3002001, TXP3001501, PZP3000301
---------	--

ID-SE7 | € 17,00

Jogo bits impacto 1/4", 7 peças.



Acessórios	chave de bits reversível impacto 1/4"
------------	---------------------------------------

Extractores parafusos	nº 1, 2, 3
-----------------------	------------

Bits impacto 50mm	
-------------------	--

Contém:	PH5000103, SE141, SE142, SE143, FL5005A03, PH5000203
---------	--

IBA-14 | € 3,80

Adaptador impacto, 1/4" HEX - 1/4" M.

**MBHI-14 | € 7,80**

Adaptador magnético 1/4", 60mm.

**QCI-14 | € 10,40**

Adaptador 1/4" 60mm, com desengate rápido.

**Acessórios 1/4"**

Bits Impacto 1/4" Philips



nºStock	Medida	Quadra	Qtd.	Comp. mm	Preço
PHP-3000101	PH1	1/4" hex	1	30	€ 2,60
PHP-3000105	PH1	1/4" hex	5	30	€ 7,50
PHP-3000201	PH2	1/4" hex	1	30	€ 2,60
PHP-3000205	PH2	1/4" hex	5	30	€ 7,50
PHP-3000301	PH3	1/4" hex	1	30	€ 2,60
PHP-3000305	PH3	1/4" hex	5	30	€ 7,50
PHP-5000101	PH1	1/4" hex	1	50	€ 2,80
PHP-5000201	PH2	1/4" hex	1	50	€ 2,80
PHP-5000301	PH3	1/4" hex	1	50	€ 2,80
PHP-8900201	PH2	1/4" hex	1	89	€ 5,60



Bits Impacto 1/4" GR



nºStock	Medida	Quadra	Qtd.	Comp. mm	Preço
GRP-3000201	GR2	1/4" hex	1	30	€ 2,65
GRP-3000205	GR2	1/4" hex	5	30	€ 7,40
GRP-5000201	GR2	1/4" hex	1	50	€ 12,80

Bits Impacto 1/4" Pozidrive



nºStock	Medida	Quadra	Qtd.	Comp. mm	Preço
PZP-3000101	PZ1	1/4" hex	1	30	€ 2,60
PZP-3000105	PZ1	1/4" hex	5	30	€ 7,50
PZP-3000201	PZ2	1/4" hex	1	30	€ 2,60
PZP-3000205	PZ2	1/4" hex	5	30	€ 7,50
PZP-3000301	PZ3	1/4" hex	1	30	€ 2,60
PZP-3000305	PZ3	1/4" hex	5	30	€ 7,50
PZP-5000101	PZ1	1/4" hex	1	50	€ 2,80
PZP-5000201	PZ2	1/4" hex	1	50	€ 2,80
PZP-5000301	PZ3	1/4" hex	1	50	€ 2,80
PZP-8900201	PZ2	1/4" hex	1	89	€ 5,60

Bits Impacto 1/4" Hexagonais



nºStock	Medida	Quadra	Qtd.	Comp. mm	Preço
HEXP-3000301	3mm	1/4" hex	1	30	€ 2,60
HEXP-3000305	3mm	1/4" hex	5	30	€ 7,50
HEXP-3000401	4mm	1/4" hex	1	30	€ 2,60
HEXP-3000405	4mm	1/4" hex	5	30	€ 7,50
HEXP-3000501	5mm	1/4" hex	1	30	€ 2,60
HEXP-3000505	5mm	1/4" hex	5	30	€ 7,50
HEXP-3000601	6mm	1/4" hex	1	30	€ 2,60
HEXP-3000605	6mm	1/4" hex	5	30	€ 7,50
HEXP-5000301	3mm	1/4" hex	1	50	€ 2,80
HEXP-5000401	4mm	1/4" hex	1	50	€ 2,80
HEXP-5000501	5mm	1/4" hex	1	50	€ 2,80
HEXP-5000601	6mm	1/4" hex	1	50	€ 2,80



nºStock	Medida	Quadra	Qtd.	Comp. mm	Preço
TXP-3001001	TX10	1/4" hex	1	30	€ 2,70
TXP-3001005	TX10	1/4" hex	5	30	€ 8,00
TXP-3001501	TX15	1/4" hex	1	30	€ 2,70
TXP-3001505	TX15	1/4" hex	5	30	€ 8,00
TXP-3002001	TX20	1/4" hex	1	30	€ 2,70
TXP-3002005	TX20	1/4" hex	5	30	€ 8,00
TXP-3002501	TX25	1/4" hex	1	30	€ 2,70
TXP-3002505	TX25	1/4" hex	5	30	€ 8,00
TXP-3002701	TX27	1/4" hex	1	30	€ 2,70
TXP-3002705	TX27	1/4" hex	5	30	€ 8,00
TXP-3003001	TX30	1/4" hex	1	30	€ 2,70
TXP-3003005	TX30	1/4" hex	5	30	€ 8,00
TXP-3004001	TX40	1/4" hex	1	30	€ 2,70
TXP-3004005	TX40	1/4" hex	5	30	€ 8,00
TXP-5001001	TX10	1/4" hex	1	50	€ 2,90
TXP-5001501	TX15	1/4" hex	1	50	€ 2,90
TXP-5002001	TX20	1/4" hex	1	50	€ 2,90
TXP-5002501	TX25	1/4" hex	1	50	€ 2,90
TXP-5002701	TX27	1/4" hex	1	50	€ 2,90
TXP-5003001	TX30	1/4" hex	1	50	€ 2,90
TXP-5004001	TX40	1/4" hex	1	50	€ 2,90
TXP-8902001	TX20	1/4" hex	1	89	€ 5,80
TXP-8902501	TX25	1/4" hex	1	89	€ 5,80
TXP-8903001	TX30	1/4" hex	1	89	€ 5,80

Bits Impacto 1/4" Torx



nºStock	Medida	Quadra	Qtd.	Comp. mm	Preço
ROBP-3000101	RS1	1/4" hex	1	30	€ 2,60
ROBP-3000105	RS1	1/4" hex	5	30	€ 7,50
ROBP-3000201	RS2	1/4" hex	1	30	€ 2,60
ROBP-3000205	RS2	1/4" hex	5	30	€ 7,50
ROBP-5000101	RS1	1/4" hex	1	50	€ 2,80
ROBP-5000201	RS2	1/4" hex	1	50	€ 2,80
ROBP-5000301	RS3	1/4" hex	1	50	€ 2,80
ROBP-8900101	RS1	1/4" hex	1	89	€ 3,90
ROBP-8900201	RS2	1/4" hex	1	89	€ 3,90
ROBP-8900301	RS3	1/4" hex	1	89	€ 3,90

Bits Impacto 1/4" Robson



Bits Impacto 1/4" Caixa



nºStock	Medida	Quadra	Tipo	Comp. mm	Preço
NSP-65108	1/4"	1/4" hex	magnético	65	€ 5,50
NSP-65507	7mm	1/4" hex	magnético	65	€ 6,00
NSP-65508	8mm	1/4" hex	magnético	65	€ 6,00
NSP-65510	10mm	1/4" hex	magnético	65	€ 6,20
NSP-65513	13mm	1/4" hex	magnético	65	€ 6,90

Chaves de Caixa Impacto 1/4"

Chaves de caixa métricas 1/4", 6 pontos. Aço-molibdénio cromado (Cr-Mo). DIN 3129.

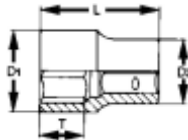

nºStock	Medida mm	L mm	T mm	D1 mm	D2 mm	Peso g	Preço
960506-C	6	21.2	10.0	9.5	12.0	20	€ 3,00
960507-C	7	21.2	11.0	11.0	12.0	20	€ 3,00
960508-C	8	21.2	11.0	12.0	12.0	20	€ 3,00
960510-C	10	21.2	12.5	14.0	12.0	30	€ 3,20
960513-C	13	21.2	12.0	18.0	18.0	30	€ 3,90

3/8"

9381 | € 20,00

Jogo 8 chaves de caixa impacto 3/8", fornecido em carril com clips.



Acessórios	carril, 8 clips para chaves 3/8"						
Chaves de caixa	3/8"	6 pontos	8, 10, 11, 13, 14, 16, 17, 19mm				

Contém : 980508-C, 980510-C, 980511-C, 980513-C, 980514-C, 980516-C, 980517-C, 980519-C

9386 | € 31,00

Jogo 8 chaves de caixa longas impacto 3/8", fornecido em carril com clips.



Acessórios	carril, 8 clips para chaves 3/8"						
Ch. caixa longas	3/8"	6 pontos	8, 10, 11, 13, 14, 16, 17, 19mm				

Contém : 980608-C, 980610-C, 980611-C, 980613-C, 980614-C, 980516-C, 980617-C, 980619-C

Acessórios 3/8"



nºStock	Quadra	Descrição	Anél retentor	Pino retentor	Preço
980020-C	3/8"	extensão 3" (norma DIN)	O92416	P902515	€ 8,60
980035-C	3/8"	adaptador 3/8"F:1/4"M	O92416	P902515	€ 8,30
980036-C	3/8"	adaptador 3/8"F:1/2"M (norma DIN)	O92416	P902515	€ 9,10
980036A-C	3/8"	adaptador 3/8"F:1/2"M (norma ANSI)	-	-	€ 8,00
980060-C	3/8"	adaptador para bits 1/4" hex	-	-	€ 5,70
980086	3/8"	3/8"M:5/16"hex	-	-	€ 2,00



Chaves de Caixa Impacto 3/8"

Chaves de caixa métricas 3/8", 6 pontos. Aço-molibdénio cromado (Cr-Mo).

nºStock	Medida mm	L mm	T mm	D1 mm	D2 mm	Peso g	Preço
980508-C	8	30.0	8.0	12.5	19.0	33	€ 3,50
980510-C	10	30.0	8.0	15.0	19.0	34	€ 3,50
980511-C	11	30.0	9.0	17.0	19.0	37	€ 3,50
980512-C	12	30.0	9.0	19.0	19.0	40	€ 3,50
980513-C	13	30.0	9.0	19.0	19.0	41	€ 3,60
980514-C	14	30.0	9.0	20.0	20.0	41	€ 4,30
980515-C	15	30.0	11.0	22.0	22.0	64	€ 4,70
980516-C	16	30.0	11.0	24.0	24.0	64	€ 4,80
980517-C	17	30.0	11.0	24.0	24.0	64	€ 4,80
980519-C	19	30.0	11.0	26.0	26.0	72	€ 5,00

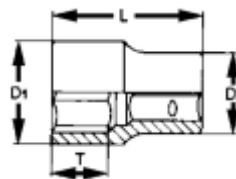

Chaves de Caixa Longas Impacto 3/8"

Chaves de caixa métricas 3/8", 6 pontos. Aço-molibdénio cromado (Cr-Mo).

nºStock	Medida mm	L mm	T mm	D1 mm	D2 mm	Peso g	Preço
980608-C	8	65.0	12.8	12.6	19.0	95	€ 5,00
980610-C	10	65.0	26.0	15.2	19.0	89	€ 5,50
980611-C	11	65.0	27.0	17.0	19.0	87	€ 5,50
980612-C	12	65.0	27.0	19.0	19.0	85	€ 5,70
980613-C	13	65.0	27.0	19.0	19.0	80	€ 5,70
980614-C	14	65.0	27.0	20.0	20.0	87	€ 5,90
980616-C	16	65.0	27.0	24.0	24.0	144	€ 6,30
980617-C	17	65.0	27.0	24.0	24.0	130	€ 6,30
980619-C	19	65.0	27.0	26.0	26.0	143	€ 6,50

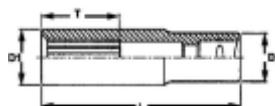

Bits Impacto 3/8" Hexagonais

Bits hexagonais com quadra 3/8". Aço-molibdénio cromado (Cr-Mo). DIN 3129.

nºStock	Medida mm	L1 mm	D1 mm	Peso g	Anel retentor	Pino retentor	Preço
981504-C	4	52.0	20.8	55	O935202	P90320	€ 10,30
981505-C	5	52.0	20.8	57	O935202	P90320	€ 10,30
981506-C	6	52.0	20.8	60	O935202	P90320	€ 10,30
981507-C	7	52.0	20.8	63	O935202	P90320	€ 10,30
981508-C	8	52.0	20.8	67	O935202	P90320	€ 10,30
981510-C	10	52.0	20.8	74	O935202	P90320	€ 11,00
981512-C	12	52.0	20.8	85	O935202	P90320	€ 11,00

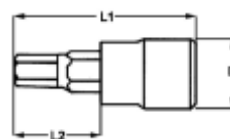

1/2"

9121 | € 37,00

Jogo 10 chaves de caixa impacto 1/2", fornecido em carril com clips. Norma ANSI.



Acessórios	carril, 10 clips para chaves 1/2"		
Chaves de caixa	1/2"	6 pontos	10, 11, 12, 13, 14, 17, 19, 21, 22, 24mm

Contém : 920510AN, 920511AN, 920512AN, 920513AN, 920514AN, 920517AN, 920519AN, 920521AN, 920522AN, 920524AN

9126 | € 56,00

Jogo 10 chaves de caixa longas impacto 1/2", fornecido em carril com clips. Norma ANSI.



Acessórios	carril, 10 clips para chaves 1/2"		
Ch. caixa longas	1/2"	6 pontos	10, 11, 12, 13, 14, 17, 19, 21, 22, 24mm

Contém : 920610AN, 920611AN, 920612AN, 920613AN, 920614AN, 920617AN, 920619AN, 920621AN, 920622AN, 920624AN

9207-S12 | € 54,00

Jogo 12 chaves de caixa curtas impacto 1/2", fornecido em carril com clips.



Acessórios	carril, 12 clips para chaves 1/2"		
Ch. caixa curtas	1/2"	6 pontos	10, 12, 13, 14, 15, 16, 17, 18, 19, 21, 22, 24mm

Contém : 920710-C, 920712-C, 920713-C, 920714-C, 920715-C, 920716-C, 920717-C, 920718-C, 920719-C, 920721-C, 920722-C, 920724-C

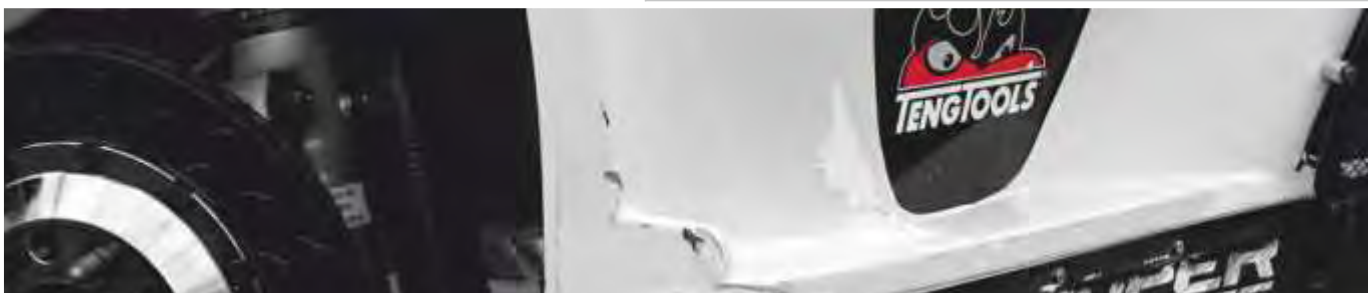

T-9206 | € 54,00

Jogo 6 bits XZN impacto com quadra de 1/2", fornecido em caixa plástica.



Bits XZN	1/2"	43mm	14, 16, 18mm
	1/2"	78mm	14, 16, 18mm

Contém : 921814, 921818, 923816, 923814, 923818, 921816



Acessórios		Pinos e Anéis	
Chaves de caixa	1/2" 6 pontos	10, 11, 12, 13, 14, 15, 16, 17, 18, 19, 21, 22, 24, 27, 28, 29, 30, 32mm	

Contém : 920510N, 920511N, 920512N, 920513N, 920514N, 920515N, 920516N, 920517N1, 920518N, 920519N1, 920521N1, 920522N, 920524N, 920527N, 920528N, 920529N, 920530N, 920532N, O92194, O92244, P92320, P92325

Acessórios		Pinos e Anéis	
Chaves de caixa	1/2" 6 pontos longas	10, 11, 12, 13, 14, 15, 16, 17, 18, 19, 21, 22, 24, 27, 28, 29, 30, 32mm	

Contém : 920610N, 920611N, 920612N, 920613N, 920614N, 920615N, 920616N, 920617N, 920618N, 920619N, 920621N, 920622N, 920624N, 920627N, 920628N, 920629N, 920630N, 920632N, O92194, O92244, P92320, P92325

Acessórios		Pinos e Anéis	
Chaves de caixa	1/2" 6 pontos	3/8", 7/16", 1/2", 9/16", 5/8", 11/16", 3/4", 13/16", 7/8", 15/16", 1", 1-1/16", 1-1/8", 1/14".	

Contém : 920112, 920114, 920116, 920118, 920120, 920122, 920124, 920126, 920128, 920130, 920134, 920136, 920140, O92244, P92320, P92325, O92194

Acessórios		Pinos e Anéis	
Chaves de caixa	1/2" 6 pontos Longa	3/8", 7/16", 1/2", 9/16", 5/8", 11/16", 3/4", 13/16", 7/8", 15/16", 1", 1-1/16", 1-1/8", 1/14".	

Contém : 920212, 920214, 920216, 920218, 920220, 920222, 920224, 920226, 920228, 920230, 920234, 920236, 920240, O92244, P92320, P92325, O92194

T-9222 | € 140,00

Jogo 22 pcs impacto com quadra de 1/2", fornecido em caixa plástica.



T-9222 L | € 220,00

Jogo 22 pcs impacto com quadra de 1/2", fornecido em caixa plástica.



T-9218 AF | € 121,00

Jogo 18 pcs impacto com quadra de 1/2", fornecido em caixa plástica.



T-9218 LAF | € 160,00

Jogo 18 pcs impacto com quadra de 1/2", fornecido em caixa plástica.



T-9240 | € 350,00

Jogo 40 pcs impacto com quadra de 1/2", fornecido em caixa plástica.



Acessórios		Pinos e Anéis	
Chaves de caixa	1/2"	6 pontos curtas e longas	10, 11, 12, 13, 14, 15, 16, 17, 18, 19, 21, 22, 24, 27, 28, 29, 30, 32mm

Contém : 920510N, 920511N, 920512N, 920513N, 920514N, 920515N, 920516N, 920517N1, 920518N, 920519N1, 920521N1, 920522N, 920524N, 920527N, 920528N, 920529N, 920530N, 920532N, 920610N, 920611N, 920612N, 920613N, 920614N, 920615N, 920616N, 920617N, 920618N, 920619N, 920621N, 920622N, 920624N, 920627N, 920628N, 920629N, 920630N, 920632N, O92194, O92244, P92320, P92325



Acessórios 1/2"



nºStock	Quadra	Descrição	Anél retentor	Pino retentor	Preço
920020N	1/2"	3" extensão. Norma DIN	O92194	P92320	€ 8,60
920020AN	1/2"	3" extensão. Norma ANSI	-	-	€ 8,30
920021N	1/2"	5" extensão. Norma DIN	O92194	P92320	€ 11,60
920021AN	1/2"	5" extensão. Norma ANSI	-	-	€ 11,20
920023N	1/2"	10" extensão. Norma DIN	O92194	P92320	€ 24,70
920023AN	1/2"	10" extensão. Norma ANSI	-	-	€ 23,70



nºStock	Quadra	Descrição	Anél retentor	Pino retentor	Preço
920030N	1/2"	Junta universal. Norma DIN	O92194	P92320	€ 21,50
920030AN	1/2"	Junta universal. Norma ANSI	-	-	€ 21,00
920036N	1/2"	Adaptador 1/2"F:3/8"M. Norma DIN	O92194	P92320	€ 9,00
920036AN	1/2"	Adaptador 1/2"F:3/8"M. Norma ANSI	-	-	€ 9,00
920037N	1/2"	Adaptador 1/2"F:3/4"M. Norma DIN	O92194	P92320	€ 11,75
920037AN	1/2"	Adaptador 1/2"F:3/4"M. Norma ANSI	-	-	€ 11,50
920060	1/2"	adaptador para bits 5/16" hex	-	-	€ 6,30

Barras de Torção 1/2" Torque Predefinido

Para uso com aparafusadoras com percussão, ao atingir o torque predefinido pela barra, a mesma salta da quadra da máquina.



nºStock	Quadra	Torque Nm	Comp. mm	Anel retentor	Pino retentor	Preço
923090	1/2"	90	200	O935202	P90320	€ 20,00
923110	1/2"	110	200	O935202	P90320	€ 20,00
923120	1/2"	120	200	O935202	P90320	€ 20,00
923140	1/2"	140	200	O935202	P90320	€ 20,00



Chaves de Caixa Impacto 1/2"

Chaves de caixa métricas 1/2", 6 pontos. Aço-molibdénio cromado (Cr-Mo). DIN 3129.

nºStock	Medida mm	L mm	T mm	D1 mm	D2 mm	Anel retentor	Pino retentor	Preço
920508-N	8	38.0	5.0	15.0	25.0	O92194	P92320	€ 6,50
920510-N	10	38.0	6.0	17.0	25.0	O92194	P92320	€ 6,50
920511-N	11	38.0	7.0	18.5	25.0	O92194	P92320	€ 6,50
920512N	12	38.0	8.0	20.0	25.0	O92194	P92320	€ 6,50
920513-N	13	38.0	8.0	21.0	25.0	O92194	P92320	€ 6,50
920514-N	14	38.0	10.0	22.5	25.0	O92194	P92320	€ 6,50
920515N	15	38.0	10.0	23.0	30.0	O92194	P92325	€ 7,30
920516-N	16	38.0	10.0	25.0	30.0	092244	P92325	€ 7,30
920517-N1	17	38.0	10.0	26.0	30.0	092244	P92325	€ 7,30
920518N	18	38.0	12.0	27.5	30.0	092244	P92325	€ 7,30
920519-N1	19	38.0	12.0	28.5	30.0	092244	P92325	€ 7,30
920520-N	20	38.0	12.0	30.0	30.0	092244	P92325	€ 7,30
920521N1	21	38.0	12.0	31.0	30.0	092244	P92325	€ 8,00
920522-N	22	38.0	14.0	32.5	30.0	092244	P92325	€ 8,00
920523-N	23	38.0	16.0	34.0	30.0	092244	P92325	€ 8,20
920524N	24	38.0	16.0	35.0	30.0	092244	P92325	€ 9,30
920525-N	25	45.0	18.0	36.0	30.0	092244	P92325	€ 9,30
920526-N	26	45.0	18.0	37.5	30.0	092244	P92325	€ 10,50
920527-N	27	45.0	18.0	38.5	30.0	092244	P92325	€ 11,20
920528-N	28	47.0	20.0	40.0	30.0	092244	P92325	€ 11,40
920529-N	29	47.0	20.0	41.0	30.0	092244	P92325	€ 11,70
920530-N	30	50.0	20.0	42.0	30.0	092244	P92325	€ 11,90
920532-N	32	50.0	22.0	44.0	30.0	092244	P92325	€ 12,90

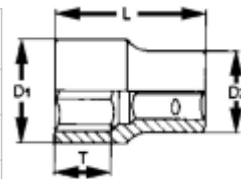

Chaves de Caixa Impacto 1/2"

Chaves de caixa métricas 1/2", 6 pontos. Aço-molibdénio cromado (Cr-Mo). Norma ANSI.

nºStock	Medida mm	L mm	T mm	D1 mm	D2 mm	Preço
920510-AN	10	38.0	4.6	17.0	22.0	€ 4,50
920511-AN	11	38.0	5.5	17.0	22.0	€ 4,50
920512-AN	12	38.0	6.1	19.0	22.0	€ 4,50
920513-AN	13	38.0	6.8	20.0	24.0	€ 4,50
920514-AN	14	38.0	8.4	21.0	24.0	€ 4,50
920515-AN	15	38.0	8.4	23.0	25.0	€ 5,00
920516-AN	16	38.0	9.5	25.0	25.0	€ 5,30
920517-AN	17	38.0	9.5	26.0	26.0	€ 5,30
920518-AN	18	38.0	10.2	28.0	26.0	€ 5,50
920519-AN	19	38.0	11.1	28.0	28.0	€ 7,30
920521-AN	21	38.0	11.7	30.0	30.0	€ 7,30
920522-AN	22	38.0	12.5	32.0	32.0	€ 7,30
920524-AN	24	38.0	13.9	36.0	36.0	€ 7,30

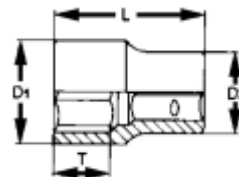

Chaves de Caixa Curtas Impacto 1/2"

Chaves de caixa métricas 1/2", 6 pontos. Aço-molibdénio cromado (Cr-Mo).
DIN 3129.

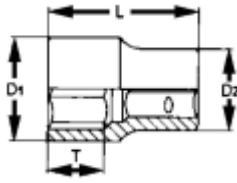

nºStock	Medida mm	L mm	T mm	D1 mm	D2 mm	Anel retentor	Pino retentor	Preço
920710-C	10	28	5.0	18	24	O935202	P90320	€ 5,90
920712-C	12	28	5.0	20	24	O935202	P90320	€ 5,90
920713-C	13	28	5.0	20	24	O935202	P90320	€ 5,90
920714-C	14	28	5.0	22	24	O935202	P90320	€ 6,00
920715-C	15	28	5.0	24	24	O935202	P90320	€ 6,00
920716-C	16	28	5.0	24	24	O935202	P90320	€ 6,00
920717-C	17	28	10.0	26	26	O93525	P90320	€ 6,70
920718-C	18	28	10.0	28	28	O93525	P90320	€ 6,80
920719-C	19	28	10.0	28	28	O93525	P90320	€ 6,80
920721-C	21	28	10.0	30	30	O93525	P90324	€ 7,00
920722-C	22	28	10.0	32	30	O93525	P90324	€ 7,50
920724-C	24	28	10.0	34	30	O93525	P90324	€ 7,50

Chaves de Caixa Longas Impacto 1/2"

Chaves de caixa métricas 1/2", 6 pontos. Aço-molibdénio cromado (Cr-Mo).
DIN3129.



nºStock	Medida mm	L mm	T mm	D1 mm	D2 mm	Anel retentor	Pino retentor	Preço
920610-N	10	80.0	9.0	17.0	25.0	O92194	P92320	€ 10,00
920611-N	11	80.0	10.5	18.5	25.0	O92194	P92320	€ 10,00
920612-N	12	80.0	12.0	20.0	25.0	O92194	P92320	€ 10,00
920613-N	13	80.0	12.0	21.0	25.0	O92194	P92320	€ 10,10
920614-N	14	80.0	15.0	22.5	25.0	O92194	P92320	€ 10,20
920615-N	15	80.0	15.0	23.0	30.0	O92244	P92325	€ 11,00
920616-N	16	80.0	15.0	25.0	30.0	O92244	P92325	€ 11,00
920617-N	17	80.0	15.0	26.0	30.0	O92244	P92325	€ 11,00
920618-N	18	80.0	18.0	27.5	30.0	O92244	P92325	€ 11,50
920619-N	19	80.0	18.0	28.5	30.0	O92244	P92325	€ 11,50
920621-N	21	80.0	18.0	31.0	30.0	O92244	P92325	€ 12,00
920622-N	22	80.0	21.0	32.5	30.0	O92244	P92325	€ 12,00
920624-N	24	80.0	24.0	35.0	30.0	O92244	P92325	€ 13,10
920627-N	27	80.0	27.0	38.5	30.0	O92244	P92325	€ 15,30
920628-N	28	80.0	30.0	40.0	30.0	O92244	P92325	€ 16,50
920629-N	29	80.0	30.0	40.0	30.0	O92244	P92325	€ 16,70
920630-N	30	80.0	30.0	42.0	30.0	O92244	P92325	€ 17,00
920632-N	32	80.0	33.0	44.0	30.0	O92244	P92325	€ 17,80
920635-N	35	80.0	33.0	48.0	30.0	O92244	P92325	€ 20,00
920636-N	36	80.0	33.0	50.0	30.0	O92244	P92325	€ 21,00



Chaves de Caixa Longas Impacto 1/2"

Chaves de caixa métricas 1/2", 6 pontos. Aço-molibdénio cromado (Cr-Mo). Norma ANSI.

nºStock	Medida mm	L mm	T mm	D1 mm	D2 mm	Preço
920610-AN	10	78.0	4.6	17.0	22.0	€ 6,80
920611-AN	11	78.0	5.5	18.0	22.0	€ 6,80
920612-AN	12	78.0	6.1	19.0	22.0	€ 6,80
920613-AN	13	78.0	6.8	22.0	24.0	€ 6,90
920614-AN	14	78.0	8.4	22.0	24.0	€ 7,20
920615-AN	15	78.0	8.4	24.0	24.0	€ 7,70
920616-AN	16	78.0	9.5	24.0	24.0	€ 7,70
920617-AN	17	78.0	9.5	26.0	26.0	€ 7,70
920618-AN	18	78.0	10.2	28.0	28.0	€ 8,20
920619-AN	19	78.0	11.1	28.0	28.0	€ 8,70
920621-AN	21	78.0	11.7	30.0	30.0	€ 9,00
920622-AN	22	78.0	12.5	32.0	32.0	€ 9,50
920624-AN	24	78.0	13.9	35.8	35.8	€ 9,60

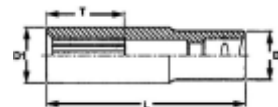

Chaves de Caixa Impacto 1/2"

Chaves de caixa 1/2", medida em polegadas, 6 pontos. Aço-molibdénio cromado (Cr-Mo). Norma DIN.

nºStock	Medida	L mm	T mm	D1 mm	D2 mm	Tipo	Anel retentor	Pino retentor	Preço
920112	3/8"	38	3.9	16.1	24	A	092194	P92320	€ 6,30
920114	7/16"	38	5.5	17.8	24	A	092194	P92320	€ 6,30
920116	1/2"	38	6.7	19.9	24	A	092194	P92320	€ 6,30
920118	9/16"	38	8.3	21.9	24	A	092194	P92320	€ 6,30
920120	5/8"	38	9.5	24	24	B	092244	P92325	€ 7,10
920122	11/16"	38	9.5	26	26	B	092244	P92325	€ 7,40
920124	3/4"	38	11.1	28	28	B	092244	P92325	€ 7,40
920126	13/16"	38	11.5	30	30	B	092244	P92325	€ 7,60
920128	7/8"	38	12.7	32	30	C	092244	P92325	€ 8,00
920130	15/16"	38	12.7	33.9	30	C	092244	P92325	€ 8,30
920132	1"	40	13.8	35.6	30	C	092244	P92325	€ 9,40
920134	1-1/16"	42	15.8	37.6	30	C	092244	P92325	€ 10,00
920136	1-1/8"	42	16.6	39.8	30	C	092244	P92325	€ 11,50
920140	1-1/4"	44	16.6	44	30	C	092244	P92325	€ 11,90

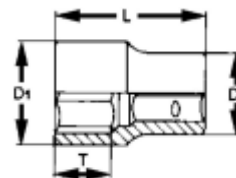

Chaves de Caixa Longas Impacto 1/2"

Chaves de caixa 1/2", medida em polegadas, 6 pontos. Aço-molibdênio cromado (Cr-Mo). Norma DIN.

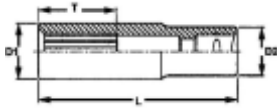

nºStock	Medida	L mm	T mm	D1 mm	D2 mm	Tipo	Anel retentor	Pino retentor	Preço
920212	3/8"	78	3.9	16	24	A	092194	P92320	€ 9,30
920214	7/16"	78	5.5	18	24	A	092194	P92320	€ 9,30
920216	1/2"	78	6.7	20.4	24	A	092194	P92320	€ 9,30
920218	9/16"	78	8.3	22	24	A	092194	P92320	€ 9,30
920220	5/8"	78	9.5	24	24	B	092244	P92325	€ 9,80
920222	11/16"	78	9.5	26	26	B	092244	P92325	€ 9,80
920224	3/4"	78	11.1	28	28	B	092244	P92325	€ 10,50
920226	13/16"	78	11.5	30	30	B	092244	P92325	€ 10,80
920228	7/8"	78	12.7	32	30	C	092244	P92325	€ 11,50
920230	15/16"	78	12.7	34	30	C	092244	P92325	€ 12,00
920232	1"	78	13.8	36	30	C	092244	P92325	€ 12,50
920234	1-1/16"	78	15.8	38	30	C	092244	P92325	€ 15,90
920236	1-1/8"	78	16.6	40	30	C	092244	P92325	€ 17,50
920240	1-1/4"	78	16.6	44.4	30	C	092244	P92325	€ 17,90
920242	1-5/16"	78	16.6	44.4	30	C	092244	P92325	€ 20,00
920248	1-1/2"	78	16.6	44.4	30	C	092244	P92325	€ 21,00



Bits Impacto 1/2" Torx

Bits TX com quadra 1/2". Aço-molibdênio cromado (Cr-Mo). Norma DIN.

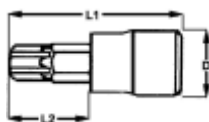

nºStock	Medida mm	L mm	D1 mm	D2 mm	Peso g	Anel retentor	Pino retentor	Preço
921210TX-C	10	78.0	6.5	25.0	73	O935202	P90320	€ 14,00
921215TX-C	15	78.0	6.5	25.0	74	O935202	P90320	€ 14,00
921220TX-C	20	78.0	6.5	25.0	74	O935202	P90320	€ 14,00
921225TX-C	25	78.0	6.5	25.0	74	O935202	P90320	€ 14,00
921227TX-C	27	78.0	6.5	25.0	78	O935202	P93020	€ 14,00
921230TX-C	30	78.0	6.5	25.0	79	O93525	P90324	€ 14,00
921240TX-C	40	78.0	8.0	25.0	86	O93525	P90324	€ 14,00
921245TX-C	45	78.0	9.0	25.0	93	O93525	P90324	€ 14,00
921250TX-C	50	78.0	10.0	25.0	98	O93525	P90324	€ 14,00
921255TX-C	55	78.0	12.0	25.0	109	O93525	P90324	€ 14,00
921260TX-C	60	78.0	14.0	25.0	122	O93525	P90324	€ 14,00
921270TX-C	70	78.0	16.0	25.0	148	O93525	P90324	€ 14,00



Bits Impacto 1/2" Hexagonais

Bits hexagonais com quadra 1/2". Aço-molibdênio cromado (Cr-Mo). DIN 3129.

nºStock	Medida mm	L1 mm	D1 mm	Peso g	Anel retentor	Pino retentor	Preço
921505-C	5	78.0	25.0	81	O935202	P90320	€ 14,00
921506-C	6	78.0	25.0	86	O935202	P90320	€ 14,00
921508-C	8	78.0	25.0	100	O935202	P90320	€ 14,00
921510-C	10	78.0	25.0	114	O935202	P90320	€ 14,90
921512-C	12	78.0	25.0	132	O935202	P90320	€ 14,90
921514-C	14	78.0	25.0	155	O935202	P90320	€ 14,90
921517-C	17	78.0	25.0	191	O935202	P90320	€ 15,50
921519-C	19	78.0	25.0	216	O935202	P90320	€ 15,50



Bits Impacto 1/2" Hexagonais

Bits hexagonais com quadra 1/2", medida em polegadas. Aço-molibdênio cromado (Cr-Mo). Norma DIN.

nºStock	Medida	L1 mm	D1 mm	Anel retentor	Pino retentor	Preço
921606	3/16"	78	24.8	092194	P92320	€ 14,00
921608	1/4"	78	24.8	092194	P92320	€ 14,00
921610	5/16"	78	24.8	092194	P92320	€ 14,00
921612	3/8"	78	24.8	092194	P92320	€ 14,80
921614	7/16"	78	24.8	092244	P92325	€ 14,80
921616	1/2"	78	24.8	092244	P92325	€ 14,80
921618	9/16"	78	24.8	092244	P92325	€ 14,80
921620	5/8"	78	24.8	092244	P92325	€ 15,60
921622	11/16"	78	24.8	092244	P92325	€ 15,60
921624	3/4"	78	24.8	092244	P92325	€ 15,60



Bits Impacto 1/2" XZN

Bits XZN com quadra 1/2". Aço-molibdênio cromado (Cr-Mo), acabamento fosfatado.

nºStock	Medida mm	L1 mm	L2 mm	D mm	Peso g	Peso
921814-C	14	43.0	23.0	25.0	73.0	€ 11,20
921816-C	16	43.0	23.0	25.0	77.0	€ 11,20
921817-C	17	43.0	23.0	25.0	82.0	€ 12,50
921818-C	18	43.0	23.0	25.0	82.0	€ 12,50
923814-C	14	78.0	53.0	25.0	127.0	€ 12,20
923816-C	16	78.0	53.0	25.0	134.0	€ 12,20
923817-C	17	78.0	53.0	25.0	134.0	€ 13,50
923818-C	18	78.0	53.0	25.0	151.0	€ 13,50



3/4"

T-9417 | € 260,00

Jogo 17 pcs impacto com quadra de 3/4", fornecido em caixa plástica.



Acessórios		Pinos e Aneis	
Chaves de caixa	3/4" 6 pontos	19, 21, 22, 23, 24, 27, 30, 32, 33, 34, 36, 38, 41, 46, 50mm	

Contém : 940519-C, 940521-C, 940522-C, 940523-C, 940524-C, 940527-C, 940530-C, 940532-C, 940533-C, 940534-C, 940536-C, 940538-C, 940541-C, 940546-C, 940550-C, O95036, P90435



T-9417 L | € 370,00

Jogo 17 pcs impacto com quadra de 3/4", fornecido em caixa plástica.



Acessórios		Pinos e Aneis	
Chaves de caixa	3/4" 6 pontos longas	19, 21, 22, 23, 24, 27, 30, 32, 33, 34, 36, 38, 41, 46, 50mm	

Contém : 940619-C, 940621-C, 940622-C, 940623-C, 940624-C, 940627-C, 940630-C, 940632-C, 940633-C, 940634-C, 940636-C, 940638-C, 940641-C, 940646-C, 940650-C, O95036, P90435

T-9423 AF | € 373,00

Jogo 23 pcs impacto com quadra de 3/4", fornecido em caixa plástica.



Acessórios		Pinos e Aneis	
Chaves de caixa	3/4" 6 pontos	11/16", 3/4", 13/16", 7/8", 15/16", 1", 1-1/16", 1-1/8", 1-3/16", 1-1/4", 1-5/16", 1-3/8", 1-7/16", 1-1/2", 1-9/16", 1-5/8", 1-11/16", 3/4", 7/8", 1-15/16", 2", 1-3/4", 1-13/16", 1-7/8"	

Contém : 940122, 940124, 940126, 940128, 940130, 940132, 940134, 940136, 940138, 940140, 940142, 940144, 940146, 940148, 940150, 940152, 940154, 940156, 940160, 940162, 940164, O95036, P90435

T-9421 LAF | € 455,00

Jogo 21 pcs impacto com quadra de 3/4", fornecido em caixa plástica.



Acessórios		Pinos e Aneis	
Chaves de caixa	3/4" 6 pontos longas	3/4", 13/16", 7/8", 15/16", 1", 1-1/16", 1-1/8", 1-3/16", 1-1/4", 1-5/16", 1-3/8", 1-7/16", 1-1/2", 1-9/16", 1-5/8", 1-11/16", 1-3/4", 1-13/16", 1-7/8"	

Contém : 940224, 940226, 940228, 940230, 940232, 940234, 940236, 940238, 940240, 940242, 940244, 940246, 940248, 940250, 940252, 940254, 940256, 940258, 940260, O95036, P90435



Chaves de Caixa Impacto 3/4"

Chaves de caixa métricas 3/4", 6 pontos. Com furação para pino e anel retentor. Aço-molibdênio cromado (Cr-Mo).

nºStock	Medida mm	L mm	T mm	D1 mm	D2 mm	Peso g	Anel retentor	Pino retentor	Preço
940519-C	19	50.0	13.0	33.0	44.0	247	O95036	P90435	€ 17,80
940521-C	21	50.0	15.0	35.0	44.0	250	O95036	P90435	€ 18,00
940522-C	22	50.0	15.0	37.0	44.0	252	O95036	P90435	€ 18,10
940523-C	23	50.0	16.0	38.0	44.0	252	O95036	P90435	€ 18,10
940524-C	24	50.0	16.0	39.0	44.0	255	O95036	P90435	€ 18,30
940527-C	27	54.0	19.0	43.0	44.0	270	O95036	P90435	€ 18,50
940528-C	28	54.0	19.0	44.0	44.0	300	O95036	P90435	€ 18,50
940530-C	30	54.0	21.0	47.0	44.0	330	O95036	P90435	€ 18,60
940532-C	32	56.0	22.0	48.0	44.0	330	O95036	P90435	€ 19,00
940533-C	33	56.0	22.0	51.0	44.0	395	O95036	P90435	€ 19,00
940534-C	34	56.0	22.0	52.0	44.0	420	O95036	P90435	€ 19,20
940536-C	36	56.0	25.0	54.0	44.0	455	O95036	P90435	€ 19,20
940538-C	38	58.0	25.0	57.0	44.0	465	O95036	P90435	€ 21,00
940540-C	40	58.0	25.0	58.0	44.0	530	O95036	P90435	€ 25,80
940541-C	41	58.0	27.0	60.0	44.0	610	O95036	P90435	€ 27,00
940546-C	46	63.0	30.0	67.0	44.0	775	O95036	P90435	€ 31,70
940550-C	50	68.0	30.0	71.0	44.0	839	O95036	P90435	€ 34,80

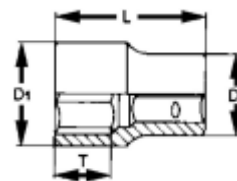

Chaves de Caixa Longas Impacto 3/4"

Chaves de caixa métricas 3/4", 6 pontos. Com furação para pino e anel retentor. Aço-molibdênio cromado (Cr-Mo).

nºStock	Medida mm	L mm	T mm	D1 mm	D2 mm	Peso g	Anel retentor	Pino retentor	Preço
940619-C	19	95.0	31	33.0	44.0	595	O95036	P90435	€ 27,50
940621-C	21	95.0	31	35.0	44.0	610	O95036	P90435	€ 28,00
940622-C	22	95.0	31	37.0	44.0	620	O95036	P90435	€ 28,00
940623-C	23	95.0	31	38.0	44.0	630	O95036	P90435	€ 28,00
940624-C	24	95.0	31	39.0	44.0	640	O95036	P90435	€ 28,00
940627-C	27	95.0	31	43.0	44.0	680	O95036	P90435	€ 28,00
940630-C	30	95.0	33	47.0	44.0	720	O95036	P90435	€ 28,20
940632-C	32	95.0	33	49.0	44.0	870	O95036	P90435	€ 28,20
940633-C	33	95.0	34	51.0	44.0	860	O95036	P90435	€ 28,50
940634-C	34	95.0	34	52.0	44.0	810	O95036	P90435	€ 29,00
940636-C	36	95.0	36	54.0	44.0	830	O95036	P90435	€ 31,00
940638-C	38	95.0	36	57.0	44.0	920	O95036	P90435	€ 34,00
940641-C	41	95.0	36	58.0	44.0	790	O95036	P90435	€ 36,00
940646-C	46	95.0	36	67.0	44.0	900	O95036	P90435	€ 44,20
940650-C	50	95.0	36	71.0	44.0	1,227	O95036	P90435	€ 49,00

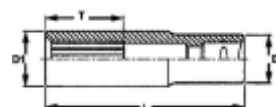

Chaves de Caixa Impacto 3/4"

Chaves de caixa 3/4", medida em polegadas, 6 pontos. Aço-molibdénio cromado (Cr-Mo). Norma DIN.

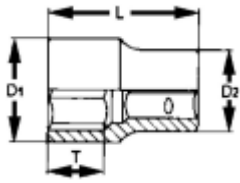

nºStock	Medida	L mm	T mm	D1 mm	D2 mm	Tipo	Anel retentor	Pino retentor	Preço
940122	11/16"	51	14	29.5	41.4	A	095036	P90435	€ 15,20
940124	3/4"	51	14	32	41.4	A	095036	P90435	€ 15,20
940126	13/16"	51	14	35	41.4	A	095036	P90435	€ 15,50
940128	7/8"	51	14	36	41.4	A	095036	P90435	€ 15,50
940130	15/16"	51	16.5	38.5	41.4	A	095036	P90435	€ 16,00
940132	1"	53	16.5	40	41.4	A	095036	P90435	€ 16,00
940134	1-1/16"	53	20	42.5	44	A	095036	P90435	€ 16,50
940136	1-1/8"	53	20	44	44	B	095036	P90435	€ 16,80
940138	1-3/16"	53	20	46	44	C	095036	P90435	€ 17,30
940140	1-1/4"	57	21	48.5	44	C	095036	P90435	€ 18,00
940142	1-5/16"	57	21	50	44	C	095036	P90435	€ 18,50
940144	1-3/8"	57	21	52.5	44	C	095036	P90435	€ 18,80
940146	1-7/16"	57	21	53.5	44	C	095036	P90435	€ 19,00
940148	1-1/2"	57	22	56	44	C	095036	P90435	€ 19,20
940150	1-9/16"	58	22	58.5	44	C	095036	P90435	€ 21,00
940152	1-5/8"	58	22	60	44	C	095036	P90435	€ 21,80
940154	1-11/16"	62	25	63.5	44	C	095036	P90435	€ 22,80
940156	1-3/4"	62	25	64.5	44	C	095036	P90435	€ 23,70
940160	1-7/8"	68	30	68	44	C	095036	P90435	€ 28,80
940162	1-15/16"	68	30	70	44	C	095036	P90435	€ 31,50
940164	2"	68	30	71	44	C	095036	P90435	€ 31,50
940166	2-1/16"	71	32	73	54	C	095036	P90435	€ 42,00
940168	2-1/8"	71	32	75.5	54	C	095036	P90435	€ 42,60
940170	2-3/16"	71	32	77.5	54	C	095036	P90435	€ 45,00
940172	2-1/4"	73	34	80	54	C	095036	P90435	€ 46,50
940174	2-5/16"	73	34	81	54	C	095036	P90435	€ 51,00
940176	2-3/8"	73	34	83	54	C	095036	P90435	€ 52,80

Bits Impacto 3/4" Hexagonais

Bits hexagonais com quadra 3/4". Com furação para pino e anel retentor. Aço-molibdénio cromado (Cr-Mo).

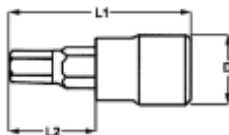

nºStock	Medida mm	L mm	T mm	D1 mm	D2 mm	Anel retentor	Pino Retentor	Preço
941519-C	19	90.0	20.0	44.0	600	095036	P90435	€ 44,30
941522-C	22	90.0	22.5	44.0	600	095036	P90435	€ 45,00
941524-C	24	90.0	22.5	44.0	600	095036	P90435	€ 46,00



Chaves de Caixa Impacto 3/4"

Chaves de caixa 3/4", medida em polegadas, 6 pontos. Aço-molibdênio cromado (Cr-Mo). Norma DIN.

nºStock	Medida	L mm	T mm	D1 mm	D2 mm	Tipo	Anel retentor	Pino retentor	Preço
940224	3/4"	90	26	32	41.4	A	095036	P90435	€ 26,00
940226	13/16"	90	26	35	41.4	A	095036	P90435	€ 26,40
940228	7/8"	90	26	36	41.4	A	095036	P90435	€ 26,40
940230	15/16"	90	26	38.5	41.4	A	095036	P90435	€ 26,50
940232	1"	90	26	40	41.4	A	095036	P90435	€ 27,00
940234	1-1/16"	90	28	42.5	44	A	095036	P90435	€ 27,00
940236	1-1/8"	90	28	44	44	B	095036	P90435	€ 27,00
940238	1-3/16"	90	28	46	44	C	095036	P90435	€ 27,00
940240	1-1/4"	90	28	48.5	44	C	095036	P90435	€ 27,00
940242	1-5/16"	90	30	50	44	C	095036	P90435	€ 28,30
940244	1-3/8"	90	30	52.5	44	C	095036	P90435	€ 28,50
940246	1-7/16"	90	30	53.5	44	C	095036	P90435	€ 28,50
940248	1-1/2"	90	34	56	44	C	095036	P90435	€ 31,00
940250	1-9/16"	90	34	58.5	44	C	095036	P90435	€ 33,30
940252	1-5/8"	90	34	60	44	C	095036	P90435	€ 33,50
940254	1-11/16"	90	34	63.5	44	C	095036	P90435	€ 36,30
940256	1-3/4"	90	34	64.5	44	C	095036	P90435	€ 26,00
940258	1-13/16"	90	34	66	44	C	095036	P90435	€ 37,60
940260	1-7/8"	90	34	68	44	C	095036	P90435	€ 40,00

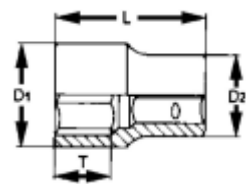

Chave de Caixa 32x400mm Impacto 3/4"

Chaves de caixa métrica 3/4", 6 pontos. Com furação para pino e anel retentor. Aço-molibdênio cromado (Cr-Mo).

nºStock	Medida mm	L mm	T mm	D1 mm	D2 mm	Peso g	Anel retentor	Pino Retentor	Preço
940732-C	32	400	22	48	44	1850	095036	P90435	€ 76,50

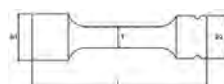

Acessórios 3/4"

nºStock	Quadra	Descrição	Anel retentor	Pino retentor	Preço
940022-C	3/4"	7" extensão	095036	P90435	€ 33,00
940030-C	3/4"	Junta universal	093538	P90437	€ 57,00
940037-C	3/4"	Adaptador 3/4"F:1/2"M	095036	P90435	€ 20,00
940085-C	3/4"	Adaptador 3/4"F:1"M	095036	P90435	€ 22,00



1"

9113 | € 228,00

Jogo 13 pcs impacto com quadra de 1", fornecido em caixa metálica.



Acessórios		Adaptador 1-3/4", Pinos e Anéis		
Chaves de caixa	1"	6 pontos	27, 30, 32, 36, 38, 41, 46, 50mm	

Contém : 910527, 910530, 910532, 910536, 910538, 910541, 910546, 910550, 940085-C, O95036, O97045, P90435, P90545



9117 | € 550,00

Jogo 17 pcs impacto com quadra de 1", fornecido em caixa metálica.



Acessórios		Adaptador 1-3/4", Pinos e Anéis		
Chaves de caixa	1"	6 pontos	36, 41, 46, 50, 55, 60, 65, 70, 75, 80, 85mm	

Contém : 910536, 910541, 910546, 910550, 910555, 910560, 910565, 910570, 910575, 910580, 940085-C, O95034, O97045, O97051, P90435, P90545, P90551

Chaves de Caixa Impacto 1"

Chaves de caixa métricas 1", 6 pontos. Com furação para pino e anel retentor. Aço-molibdênio cromado (Cr-Mo).

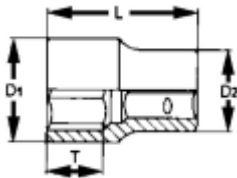

nºStock	Medida mm	L mm	T mm	D1 mm	D2 mm	Peso g	Anel retentor	Pino retentor	Preço
910524	24	58.0	18.0	41.0	54.0	640	O97045	P90545	€ 27,70
910527	27	58.0	20.0	46.0	54.0	645	O97045	P90545	€ 27,70
910530	30	60.0	21.0	49.0	54.0	680	O97045	P90545	€ 27,70
910532	32	60.0	21.0	52.0	54.0	700	O97045	P90545	€ 27,70
910533	33	60.0	21.0	53.0	54.0	700	O97045	P90545	€ 27,70
910534	34	60.0	21.0	55.0	54.0	690	O97045	P90545	€ 27,70
910536	36	65.0	30.0	56.0	54.0	700	O97045	P90545	€ 28,20
910538	38	65.0	30.0	59.0	54.0	750	O97045	P90545	€ 28,60
910541	41	67.0	30.0	63.0	54.0	850	O97045	P90545	€ 31,00
910546	46	74.0	40.0	69.0	54.0	1005	O97045	P90545	€ 37,50
910550	50	80.0	43.0	74.0	54.0	1220	O97045	P90545	€ 42,00
910555	55	84.0	43.0	80.0	54.0	1470	O97045	P90545	€ 52,50
910560	60	87.0	46.0	86.0	54.0	1610	O97045	P90545	€ 61,50
910565	65	90.0	49.0	92.0	54.0	1890	O97045	P90545	€ 70,70
910570	70	96.0	51.0	99.0	54.0	2355	O97045	P90545	€ 85,00
910575	75	98.0	52.0	104.0	54.0	2455	O97051	P90551	€ 111,00
910580	80	100.0	52.0	109.0	86.0	3750	O97051	P90551	€ 124,00
910585	85	100.0	52.0	115.0	86.0	4750	O910075	P90675	€ 145,00
910590	90	100.0	55.0	119.0	86.0	6000	O910075	P90675	€ 154,00
910595	95	100.0	55.0	130.0	86.0	6500	O97045	P90545	€ 181,00



Chaves de Caixa Impacto 1" Parede Fina

Chaves de caixa métricas 1", 6 pontos. Aço-molibdénio cromado (Cr-Mo). Norma DIN.

nºStock	Medida mm	L mm	T mm	D1 mm	D2 mm	Peso g	Anel retentor	Pino retentor	Preço
910624	24	100.0	28.0	38.0	54.0	830	O97045	P90545	€ 50,50
910627	27	100.0	28.0	43.0	54.0	895	O97045	P90545	€ 51,00
910628	28	100.0	28.0	43.0	54.0	895	O97045	P90545	€ 51,50
910630	30	100.0	42.0	45.0	54.0	945	O97045	P90545	€ 51,90
910632	32	100.0	45.0	47.0	54.0	935	O97045	P90545	€ 52,00
910633	33	100.0	45.0	49.0	54.0	980	O97045	P90545	€ 54,00
910636	36	100.0	66.0	52.0	54.0	870	O97045	P90545	€ 57,00



Chaves de Caixa Longas Impacto 1"

Chaves de caixa métricas 1", 6 pontos. Com furação para pino e anel retentor. Aço-molibdénio cromado (Cr-Mo).

nºStock	Medida mm	L mm	T mm	D1 mm	D2 mm	Peso g	Anel retentor	Pino retentor	Preço
910627-R	27	100.0	50.0	46.0	54.0	990	O97045	P90545	€ 39,00
910630-R	30	100.0	50.0	50.0	54.0	1040	O97045	P90545	€ 40,00
910632-R	32	100.0	50.0	52.0	54.0	1060	O97045	P90545	€ 40,00
910633-R	33	100.0	50.0	53.0	54.0	1070	O97045	P90545	€ 41,00



Chave de Caixa 32x400mm Impacto 1"

Chaves de caixa métrica 1", 6 pontos. Com furação para pino e anel retentor. Aço-molibdénio cromado (Cr-Mo).

nºStock	Medida mm	L mm	T mm	D1 mm	D2 mm	Peso g	Anel retentor	Pino Retentor	Preço
910732	32	270	28	48	54	1840	O97045	P90545	€ 88,00

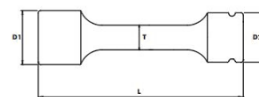

Acessórios 1"

nºStock	Quadra	Descrição	Anel retentor	Pino retentor	Preço
910086	1"	Adaptador 1"F: 3/4"M	O97045	P90545	€ 27,60



Aneis e Pinos de Segurança

Anéis Retentores

Anéis retentores para chaves de caixa e acessórios impacto de norma DIN.



nºStock	Medida	Preço
O92416	16x2.4mm	€ 0,75
O92419	19x2.4mm	€ 0,75
O92194	19x4.0mm	€ 0,85
O935202	20x3.5mm	€ 0,85
O92244	24x4.0mm	€ 0,85
O93525	25x3.5mm	€ 0,95
O93528	28x3.5mm	€ 1,20
O93530	30x3.5mm	€ 1,20
O93532	32x3.5mm	€ 1,20
O93534	34x3.5mm	€ 1,20
O95034	34x5mm	€ 1,50

nºStock	Medida	Preço
O95036	36x5mm	€ 2,30
O93538	38x3.5mm	€ 2,30
O97043	43x7mm	€ 2,30
O97045	45x7mm	€ 2,30
O93546	46x3.5mm	€ 2,30
O95046	46x5mm	€ 2,30
O93548	48x3.5mm	€ 2,30
O97051	51x7mm	€ 2,30
O95775	75x5.7mm	€ 3,00
O910075	75x10mm	€ 12,00
O9100115	115x10mm	€ 12,00

Pinos Retentores

Pinos retentores para chaves de caixa e acessórios impacto de norma DIN.



nºStock	Descrição	Preço
P902515	2.5x15mm	€ 0,75
P902518	2.5x18mm	€ 0,75
P92320	3x20mm	€ 0,75
P90324	3x24mm	€ 0,90
P92325	3x25mm	€ 0,90
P90328	3x28mm	€ 0,90
P90332	3x32mm	€ 0,90
P90437	4x37mm	€ 0,90

nºStock	Descrição	Preço
P90433	4x33mm	€ 2,30
P90435	4x35mm	€ 2,30
P90445	4x45mm	€ 2,30
P90543	5x43mm	€ 2,60
P90545	5x45mm	€ 2,60
P90551	5x51mm	€ 2,60
P90675	6x75mm	€ 6,10
P906110	6x110mm	€ 6,10

TABULEIROS IMPACTO

Na nossa secção de tabuleiros TT e EVA



Chaves de Bocas

6208 | € 38,50

Jogo 8 chaves de bocas. Fornecido em caixa de cartão. DIN 3110, ISO 3318.

Chaves bocas	6x7, 8x9, 10x11, 12x13, 14x15, 16x17, 18x19, 20x22mm
--------------	--

6211 | € 72,50

Jogo 11 chaves de bocas. Fornecido em caixa de cartão. DIN 3110, ISO 3318.



Chaves bocas	6x7m, 8x9, 10x11, 12x13, 14x15, 16x17, 18x19, 20x22, 21x23, 24x27, 30x32mm
--------------	--



6211-MM | € 104,00

Jogo 11 chaves de bocas. Fornecido em estojo. DIN 3110, ISO 3318.



Chaves bocas	6x7, 8x9, 10x11, 12x13, 14x15, 16x17, 18x19, 20x22, 21x23, 24x27, 30x32mm
--------------	---

Chaves de Bocas

Chaves bocas, angulo de 15°. DIN 3110.

Aço-vanádio cromado, acabamento acetinado. DIN 3113A.



nºStock	Medida	L mm	H mm	D1 mm	D2 mm	T mm	Peso g	Preço
620607	6x7	123	3.7	18.0	15.5	3.7	25	€ 3,90
620809	8x9	140	4.0	22.7	20.4	4.0	35	€ 3,90
621011	10x11	156	5.0	27.1	24.9	5.0	50	€ 4,70
621213	12x13	172	5.5	31.2	29.2	5.5	75	€ 5,70
621415	14x15	188.5	5.9	35.3	33.3	5.9	105	€ 6,30
621617	16x17	204	6.3	38.9	37.1	6.3	155	€ 7,00
621819	18x19	221	6.7	42.8	40.9	6.7	190	€ 7,80
622022	20x22	237	7.1	48.8	44.8	7.1	220	€ 9,80
622123	21x23	247	7.7	50.8	46.8	7.7	245	€ 11,00
622427	24x27	263	8.1	59.1	52.8	8.1	305	€ 14,00
623032	30x32	298	9.0	69.8	65.4	9.0	465	€ 19,00



6607-AF | € 74,00

Jogo 7 chaves de bocas. Fornecido em estojo. DIN 3110, ISO 3318.

Chaves bocas

1/4x5/16, 3/8x7/16, 1/2x9/16, 5/8x3/4, 13/16x7/8, 15/16x1-1/8x1-1/4"

**Chaves de Bocas**

Chaves bocas, ângulo de 15°. DIN 3110.

Aço-vanádio cromado, acabamento acetinado. DIN 3113A

nºStock	Medida plg	L mm	H mm	D1 mm	D2 mm	T mm	Peso g	Preço
663032	1/4x5/16	123	2.9	18.0	15.5	2.9	25	€ 4,80
663436	3/8x7/16	156	3.4	27,1	24.9	3.4	61	€ 6,80
663840	1/2x9/16	180	4.0	33.3	31.3	4.0	85	€ 7,50
664244	5/8x3/4	221	4.6	42.8	37.1	4.6	160	€ 9,70
664648	13/16x7/8	237	4.9	48.8	44.8	4.9	220	€ 10,50
665052	15/16x1	255	5.3	56.8	50.8	5.3	298	€ 17,80
665456	1-1/8x1-1/4	298	6.0	69.8	65.4	6	470	€ 22,60

**Chaves de Luneta****6308 | € 68,00**

Jogo 8 chaves luneta, com inclinação de 75°. Fornecido em caixa de cartão.

Chaves luneta

6x7, 8x9, 10x11, 12x13, 14x15, 16x17, 18x19, 20x22mm

6311 | € 116,00

Jogo 11 chaves luneta, com inclinação de 75°. Fornecido em caixa de cartão.

Chaves luneta

6x7, 8x9, 10x11, 12x13, 14x15, 16x17, 18x19, 20x22, 21x23, 24x27, 30x32mm



6308-MM | € 72,00

Jogo 8 chaves luneta, com inclinação de 75°. Fornecido em estojo. DIN 838.



Chaves luneta 6x7, 8x9, 10x11, 12x13, 14x15, 16x17, 18x19, 20x22mm

Chaves Luneta

Chaves luneta, com inclinação de 75°. DIN 838.

Aço-vanádio cromado, acabamento acetinado. DIN 3113A.

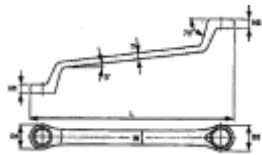

nºStock	Medida	L mm	H1 mm	H2 mm	D1 mm	D2 mm	T mm	Peso g	Preço
630607	6x7	168	5.6	6.3	10.7	12.2	4.1	45	€ 7,20
630809	8x9	183	6.6	7.0	13.6	15.1	4.5	60	€ 7,80
631011	10x11	198	7.4	7.7	16.6	18.0	4.9	100	€ 8,80
631213	12x13	217	8.1	8.4	19.5	20.9	5.4	105	€ 8,80
631415	14x15	239	8.8	9.1	22.4	23.7	5.7	145	€ 10,00
631617	16x17	260	9.5	9.8	25.3	26.7	6.2	195	€ 10,50
631819	18x19	292	10.1	10.4	28.2	29.7	6.6	250	€ 12,10
632022	20x22	318	10.9	11.4	31.1	34.0	7.1	320	€ 15,30
632123	21x23	326.5	11.2	11.6	32.6	35.5	7.6	340	€ 17,00
632427	24x27	329	12.4	13.4	36.9	41.0	8.1	475	€ 20,00
633032	30x32	362	14.4	15.2	45.5	48.5	9.0	522	€ 25,00

6707-AF | € 105,00

Jogo 7 chaves luneta, com inclinação de 75°. Fornecido em estojo. DIN 838.



Chaves luneta 1/4x5/16, 3/8x7/16, 1/2x7/16, 13/16x1-1/16, 15/16x1-1/16, 1x1-1/8, 1-1/8x1-1/4"

Chaves Luneta

Chaves luneta, com inclinação de 75°. DIN 838.

Aço-vanádio cromado, acabamento acetinado. DIN 3113A.

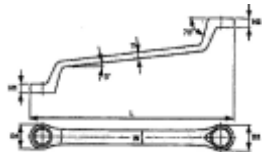

nºStock	Medida plg	L mm	H mm	H2 mm	D1 mm	D2 mm	T mm	Peso g	Preço
673032	1/4x5/16	168	5.6	6.3	10.7	12.2	4.1	45	€ 8,30
673436	3/8x7/16	198	7.4	7.7	16.6	18.0	4.9	93	€ 9,20
673840	1/2x7/16	217	8.1	7.7	19.5	20.9	5.4	135	€ 9,90
674244	13/16x7/8	318	10.9	11.4	31.1	34.0	7.1	325	€ 16,50
674648	15/16x1-1/16	347	12.4	13.4	36.9	40.5	8.1	475	€ 21,50
675052	1x1-1/8	355	12.7	13.7	38.4	42.8	8.5	570	€ 26,40
675456	1-1/8x1-1/4	362	14.4	15.2	45.5	48.5	9.0	650	€ 27,20



601013 | € 6,60

Chave luneta compacta 10/13mm, com comprimento de 120mm. DIN 3113A.

**Chaves Luneta - Longas**

Chaves luneta planas, acabamento acetinado.

nºStock	Medida	L mm	A mm	B mm	C mm	D mm	Peso g	Preço
630810-FL	8x10	265	12.5	15.0	7.5	8.4	72	€ 23,20
631113-FL	11x13	328	17.8	20.3	10.4	11.3	155	€ 30,00
631214-FL	12x14	328	17.8	20.3	10.4	11.3	157	€ 30,00
631618-FL	16x18	408	23.4	26.3	12.8	14.4	284	€ 38,30
631719-FL	17x19	407	23.7	26.6	13.0	14.8	284	€ 38,30
632224-FL	22x24	430	31.3	34.0	15.4	17.7	482	€ 51,00

**Chaves Boca-Luneta****6512-N | € 67,00**

Jogo 12 chaves métricas boca/luneta. Luneta 15° de inclinação. Fornecido em caixa de cartão.

Chaves boca/luneta 8, 9, 10, 11, 12, 13, 14, 15, 16, 17, 18, 19mm

6512 | € 67,00

Jogo 12 chaves métricas boca/luneta. Luneta 15° de inclinação. Fornecido em caixa de cartão.

Chaves boca/luneta 8, 9, 10, 11, 12, 13, 14, 15, 16, 17, 19, 22mm

6517 | € 98,00

Jogo 17 chaves métricas boca/luneta. Luneta 15° de inclinação. Fornecido em caixa de cartão.

Chaves boca/luneta 6, 7, 8, 9, 10, 11, 12, 13, 14, 15, 16, 17, 18, 19, 20, 21, 22mm

6521 | € 157,00

Jogo 21 chaves métricas boca/luneta. Luneta 15° de inclinação. Fornecido em caixa de cartão.

Chaves boca/luneta 6, 7, 8, 9, 10, 11, 12, 13, 14, 15, 16, 17, 18, 19, 20, 21, 22, 24, 27, 30, 32mm



6510-MM | € 59,00

Jogo 10 chaves métricas boca/luneta. Luneta 15° de inclinação. Fornecido em estojo.

Chaves boca/luneta 8, 9, 10, 11, 12, 13, 14, 15, 17, 19mm

6512-MM1 | € 70,00

Jogo 12 chaves métricas boca/luneta. Luneta 15° de inclinação. Fornecido em estojo.

Chaves boca/luneta 8, 9, 10, 11, 12, 13, 14, 15, 16, 17, 18, 19mm



6515-MM | € 84,00

Jogo 15 chaves métricas boca/luneta. Luneta 15° de inclinação. Fornecido em estojo.

Chaves boca/luneta 5.5, 6, 7, 8, 9, 10, 11, 12, 13, 14, 15, 16, 17, 18, 19mm



6517-MM | € 113,00

Jogo 17 chaves métricas boca/luneta. Luneta 15° de inclinação. Fornecido em estojo.

Chaves boca/luneta 6, 7, 8, 9, 10, 11, 12, 13, 14, 15, 16, 17, 18, 19, 20, 21, 22mm



6512-MM | € 170,00

Jogo 12 chaves métricas boca/luneta. Luneta 15° de inclinação. Fornecido em estojo.

Chaves boca/luneta 20, 21, 22, 23, 24, 25, 26, 27, 28, 29, 30, 32mm

6526-MM | € 247,00

Jogo 26 chaves métricas boca/luneta. Luneta 15° de inclinação. Fornecido em estojo.

Chaves boca/luneta 6, 7, 8, 9, 10, 11, 12, 13, 14, 15, 16, 17, 18, 19, 20, 21, 22, 23, 24, 25, 26, 27, 28, 29, 30, 32mm

6507-JMM | € 313,00

Jogo 7 chaves métricas boca/luneta. Luneta 15° de inclinação. Fornecido em estojo.

Chaves boca/luneta 33, 34, 36, 38, 41, 46, 50mm



6510-A | € 56,00

Jogo 10 chaves métricas boca/luneta. Fornecido em suporte plástico. DIN 3113A.

Chaves boca/luneta 8, 10, 11, 12, 13, 14, 15, 16, 17, 19mm

**6515-MMA | € 81,00**

Jogo 15 chaves métricas boca/luneta. Luneta 15° de inclinação. Fornecido em suporte especial com encaixe para o suporte do jogo 6512MMA.

Chaves boca/luneta 5.5, 6, 7, 8, 9, 10, 11, 12, 13, 14, 15, 16, 17, 18, 19mm

**6512-MMA | € 165,00**

Jogo 12 chaves métricas boca/luneta. Luneta 15° de inclinação. Fornecido em suporte especial com encaixe para o suporte do jogo 6515MMA.

Chaves boca/luneta 20, 21, 22, 23, 24, 25, 26, 27, 28, 29, 30, 32mm

**6507-JMMA | € 309,00**

Jogo 7 chaves métricas boca/luneta. Luneta 15° de inclinação. Fornecido em suporte especial com encaixe para o suporte do jogo 6512MMA.

Chaves boca/luneta 33, 34, 36, 38, 41, 46, 50mm



Chaves Boca/Luneta

Chaves boca/luneta métricas, com 15° de inclinação na luneta. Aço-vanádio cromado, acabamento acetinado. DIN 3113A.

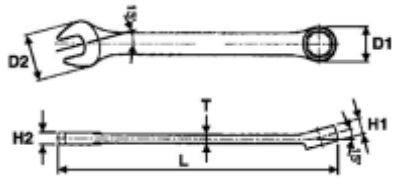

nºStock	Medida	L mm	H1 mm	H2 mm	D1 mm	D2 mm	T mm	Peso g	Preço
6005055	5.5	95	4.1	3.5	8.9	13.6	2.4	11	€ 5,00
600506	6	100	4.7	4.0	10.1	15.5	2.7	17	€ 4,60
600507	7	110	5.0	4.0	11.5	17.0	2.8	23	€ 4,60
600508	8	120	5.5	4.5	12.8	19.2	3.0	25	€ 4,60
600509	9	130	5.9	4.5	14.2	21.2	3.3	28	€ 4,90
600510	10	140	6.5	5.0	15.6	23.2	3.5	38	€ 5,00
600511	11	150	6.9	5.4	16.9	25.3	3.7	47	€ 5,30
600512	12	160	7.3	5.5	18.3	27.2	3.9	60	€ 5,80
600513	13	170	7.8	5.9	19.7	29.4	4.1	68	€ 6,00
600514	14	180	8.3	6.2	21.2	31.5	4.4	84	€ 6,30
600515	15	190	8.6	6.4	22.5	33.2	4.6	98	€ 6,50
600516	16	200	8.9	6.7	24.0	34.7	4.8	104	€ 7,20
600517	17	210	9.3	6.9	25.3	36.5	5.0	124	€ 7,70
600518	18	220	9.9	7.2	26.8	38.7	5.2	141	€ 8,90
600519	19	230	10.5	7.4	28.1	40.7	5.4	158	€ 9,10
600520	20	240	10.9	7.7	29.7	43.1	5.6	184	€ 10,00
600521	21	250	11.3	8.0	31.3	44.8	5.7	209	€ 10,20
600522	22	260	11.5	8.2	32.6	46.9	5.8	216	€ 11,60
600523	23	270	11.8	8.4	34.2	48.3	5.9	258	€ 13,50
600524	24	280	12.1	8.7	35.5	50.4	6.0	265	€ 13,70
600525	25	290	12.5	8.9	36.9	52.0	6.2	296	€ 16,20
600526	26	300	12.8	9.2	38.2	53.6	6.4	342	€ 16,90
600527	27	310	13.1	9.4	39.6	55.7	6.6	385	€ 18,40
600528	28	320	13.3	9.7	40.9	57.6	6.8	397	€ 18,70
600529	29	330	13.5	9.9	42.3	59.7	7.0	435	€ 19,50
600530	30	340	13.7	10.1	43.7	61.8	7.1	459	€ 21,90
600532	32	360	14.3	10.4	46.4	65.8	7.3	527	€ 22,80
600533	33	380	15.0	10.7	48.8	69.2	7.5	654	€ 30,30
600534	34	380	15.0	10.7	48.8	69.2	7.5	674	€ 30,30
600536	36	410	19.2	13.5	53.5	74.0	8.0	831	€ 42,40
600538	38	430	20.4	15.0	56.0	77.0	9.0	967	€ 46,30
600541	41	460	21.6	16.0	61.0	84.0	10.0	1257	€ 54,50
600546	46	500	23.0	17.0	66.0	92.0	11.0	1693	€ 73,50
600550	50	540	24.6	18.0	73.0	102.0	12.0	2048	€ 90,50
600555	55	560	21.5	28.0	86.0	118.0	14.5	2800	€ 266,80
600558	58	600	23.5	30.0	94.0	126.0	16.0	3900	€ 332,80
600560	60	600	23.5	30.0	94.0	126.0	16.0	3900	€ 335,80
600565	65	680	25.0	32.0	108.0	148.0	18.0	5800	€ 470,70
600570	70	680	25.0	32.0	108.0	148.0	18.0	5800	€ 477,00



6509-AF | € 55,00

Jogo 9 chaves boca/luneta em polegadas. Luneta 15° de inclinação. Fornecido em estojo.

Chaves boca/luneta 1/4" 5/16" 3/8" 7/16" 1/2" 9/16" 5/8" 11/16" 3/4"

6507-AF | € 103,00

Jogo 7 chaves boca/luneta em polegadas. Luneta 15° de inclinação. Fornecido em estojo.

Chaves boca/luneta 13/16" 7/8" 15/16" 1" 1 1/16" 1 1/8" 1 1/4"

6507-JAF | € 313,00

Jogo 7 chaves boca/luneta em polegadas. Luneta 15° de inclinação. Fornecido em estojo.

Chaves boca/luneta 1 5/16" 1 3/8" 1 1/2" 1 5/8", 1 3/4", 1 7/8"

**Chaves Boca/Luneta**

Chaves boca/luneta em polegadas, com 15° de inclinação na luneta. Aço-vanádio cromado, acabamento acetinado.

nºStock	Medida	L mm	H1 mm	H2 mm	D1 mm	D2 mm	T mm	Peso g	Preço
600108	1/4"	100	4.7	4.0	10.1	15.5	2.7	16	€ 5,00
600110	5/16"	120	5.5	4.5	12.8	19.2	3.0	25	€ 5,00
600112	3/8"	140	6.5	5.0	15.6	23.2	3.5	37	€ 5,30
600114	7/16"	150	6.9	5.4	16.9	25.3	3.7	50	€ 5,50
600116	1/2"	170	7.8	5.9	19.7	29.4	4.1	69	€ 6,30
600118	9/16"	180	8.3	6.2	21.2	31.5	4.4	80	€ 6,50
600120	5/8"	200	8.9	6.7	24.0	34.7	4.8	107	€ 7,30
600122	11/16"	210	9.3	6.9	25.3	36.5	5.0	127	€ 7,80
600124	3/4"	230	10.5	7.4	28.1	40.7	5.4	157	€ 9,50
600126	13/16"	250	11.3	8.0	31.3	44.8	5.7	212	€ 10,70
600128	7/8"	260	11.5	8.2	32.6	46.9	5.8	204	€ 12,80
600130	15/16"	280	12.1	8.7	35.5	50.4	6.0	264	€ 14,80
600132	1"	290	12.5	8.9	36.9	52.0	6.2	310	€ 17,70
600134	1 1/16"	310	13.1	9.4	39.6	55.7	6.6	400	€ 20,00
600136	1 1/8"	330	13.3	9.7	40.9	57.6	6.8	415	€ 21,80
600140	1 1/4"	360	14.3	10.4	46.4	65.8	7.3	540	€ 25,00
600142	1 5/16"	380	15.0	10.7	48.8	69.2	7.5	649	€ 30,90
600144	1 3/8"	410	19.2	13.5	53.0	74.0	8.0	858	€ 31,90
600146	1 7/16"	410	19.2	13.5	53.0	74.0	8.0	838	€ 43,10
600148	1 1/2"	430	20.4	15.0	56.0	77.0	9.0	1002	€ 43,10
600152	1 5/8"	460	21.6	16.0	61.0	84.0	10.0	1309	€ 55,90
600156	1 3/4"	500	23.0	17.0	66.0	92.0	11.0	1595	€ 74,90
600160	1 7/8"	540	24.6	18.0	73.0	102.0	12.0	2097	€ 100,00

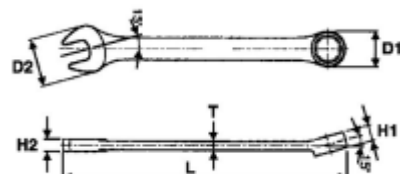

6059-LMP | € 64,00

Jogo 9 chaves longas boca/luneta, com 15° de inclinação. Forneido em estojo. Aço-vanádio cromado, acabamento acetinado.



Chaves boca/luneta 8, 10, 11, 12, 13, 14, 15, 17, 19mm

Chaves Boca/Luneta - Longas

Chaves longas boca/luneta, com 15° de inclinação. Aço-vanádio cromado, acabamento acetinado. DIN 3113A.



nºStock	Medida	L mm	H1 mm	H2 mm	D1 mm	D2 mm	T mm	Peso g	Preço
605908	8	148	5.3	4.9	12.6	17.2	3.6	33	€ 5,65
605909	9	158	6.2	5.0	13.7	19.4	3.8	40	€ 5,65
605910	10	168	6.4	5.6	15.2	21.7	3.9	50	€ 5,65
605911	11	188	7.3	5.6	16.7	23.1	4.2	62	€ 5,90
605912	12	198	7.9	6.3	17.7	25.3	4.2	77	€ 6,00
605913	13	208	8.6	6.7	19.8	26.6	4.5	87	€ 6,30
605914	14	228	9.0	7.4	21.4	29.8	5.0	117	€ 8,50
605915	15	238	9.9	7.6	22.5	32.4	5.0	142	€ 9,30
605916	16	246	10.4	8.2	23.5	32.4	5.2	153	€ 9,50
605917	17	266	10.5	8.2	25.4	36.0	5.8	174	€ 11,00
605918	18	276	12.4	9.0	26.6	37.4	5.8	215	€ 11,50
605919	19	285	12.6	9.1	28.3	39.8	6.1	220	€ 12,20

Chaves Boca/Luneta Compactas

Chaves métricas boca/luneta, com 15° de inclinação. Aço-vanádio cromado, acabamento acetinado. DIN 3113A.

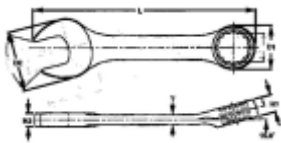

nºStock	Medida	L mm	H1 mm	H2 mm	D1 mm	D2 mm	T mm	Peso g	Preço
6005-M10	10	95	7.0	5.1	16.2	21.9	3.4	30	€ 5,10
6005-M11	11	100	7.8	5.9	17.9	23.8	4.0	42	€ 5,50
6005-M12	12	105	8.2	6.6	19.1	24.7	4.2	48	€ 6,10
6005-M13	13	110	8.8	6.7	19.3	27.1	5.0	55	€ 6,30
6005-M14	14	115	9.1	7.4	21.8	28.9	5.1	66	€ 6,50
6005-M15	15	120	9.2	7.5	22.6	31.1	5.1	71	€ 7,00
6005-M16	16	125	9.8	8.1	23.6	33.0	5.6	87	€ 7,50
6005-M17	17	130	10.3	8.3	25.9	36.0	5.6	105	€ 8,50
6005-M18	18	135	11.0	8.7	27.2	36.8	5.8	118	€ 8,90
6005-M19	19	140	11.2	9.4	28.7	38.1	6.0	130	€ 8,90



Chaves B/L Anti-deslizantes

8512-MM | € 79,00

Jogo 12 chaves boca/luneta Anti-deslizantes. Fornecido em estojo.

Chaves boca/luneta 8, 9, 10, 11, 12, 13, 14, 15, 16, 17, 18, 19mm

**8512-A | € 94,00**

Jogo 12 chaves boca/luneta Anti-deslizantes. Fornecido em caixa desdobrável magnética.

Chaves boca/luneta 8, 9, 10, 11, 12, 13, 14, 15, 16, 17, 18, 19mm



Chaves Boca/Luneta Anti-Deslizantes

Hip-grip, 15° de inclinação na luneta.

n°Stock	Medida	L mm	H1 mm	H2 mm	D1 mm	D2 mm	T mm	Peso g	Preço
800608	8	120	6.6	4.5	12.8	18.9	3.2	24	€ 5,20
800609	9	130	7.0	4.5	14.2	20.8	3.2	28	€ 5,20
800610	10	140	7.7	5.0	15.6	22.5	3.6	36	€ 5,55
800611	11	150	8.4	5.4	16.9	24.5	3.6	46	€ 5,90
800612	12	160	8.5	5.5	18.0	27.2	3.6	58	€ 6,60
800613	13	170	8.8	5.9	19.5	29.6	3.9	71	€ 6,70
800614	14	180	9.6	6.2	21.5	31.1	4.0	81	€ 7,10
800615	15	185	10.1	6.4	22.8	32.5	4.2	93	€ 7,60
800616	16	195	10.5	6.5	24.2	35.0	4.5	110	€ 8,50
800617	17	202	11.0	6.9	25.2	37.0	4.5	123	€ 8,75
800618	18	208	11.5	7.1	26.8	39.0	4.8	135	€ 9,60
800619	19	218	12.2	7.5	28.4	41.1	5.0	156	€ 10,20

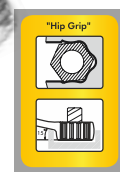
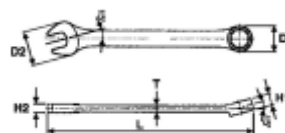

ANEL

600 | € 3,50

Porta chaves, ideal para guardar chaves luneta ou boca/luneta.



Chaves B/L c/ Roquete

6508-RMM | € 166,00

Jogo 8 chaves métricas de B/L com roquete reversível 72 dentes, 13° de inclinação. Fornecido em estojo. Aço-vanádio cromado, acabamento acetinado.

Chaves boca/luneta 8, 10, 11, 12, 13, 14, 17, 19mm

6510-RMM | € 219,00

Jogo 10 chaves métricas de B/L com roquete reversível 72 dentes, 13° de inclinação. Fornecido em estojo. Aço-vanádio cromado, acabamento acetinado.

Chaves boca/luneta 10, 11, 12, 13, 14, 15, 16, 17, 18, 19mm



Chaves de Boca/Luneta com Roquete

Chaves de B/L métricas com roquete reversível 72 dentes, 13° de inclinação. Aço-vanádio cromado, acabamento acetinado. DIN 3113A.

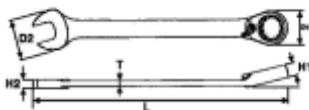

n°Stock	Medida	L mm	H1 mm	H2 mm	D1 mm	D2 mm	T mm	Peso g	Preço
600508-R	8	140	6.5	4.0	17.0	17.0	2.8	30	€ 19,90
600509-R	9	150	6.9	4.4	18.5	19.0	2.7	30	€ 20,00
600510-R	10	159	7.3	4.8	20.0	21.0	3.3	50	€ 21,40
600511-R	11	165	7.7	5.2	22.0	23.0	3.6	70	€ 23,00
600512-R	12	172	8.2	5.5	23.0	25.0	3.9	80	€ 24,70
600513-R	13	178	8.5	5.8	25.0	27.0	4.0	100	€ 25,60
600514-R	14	191	9.0	6.2	27.0	29.0	4.3	120	€ 26,80
600515-R	15	200	9.4	6.5	28.0	31.0	4.5	140	€ 27,60
600516-R	16	208	9.9	6.8	30.0	33.0	4.7	170	€ 30,00
600517-R	17	226	10.3	7.2	32.0	36.0	5.0	200	€ 30,30
600518-R	18	237	10.7	7.7	33.0	38.0	5.2	210	€ 32,80
600519-R	19	248	11.2	8.2	34.0	40.0	5.5	220	€ 33,20
600522-R	22	290	13.0	9.0	38.4	45.0	6.0	360	€ 45,40
600524-R	24	323	14.5	9.8	43.6	52.0	6.5	510	€ 54,80
600527-R	27	359	15.5	10.5	52.5	56.0	7.7	640	€ 98,80
600530-R	30	403	17.0	11.4	58.5	59.0	8.2	880	€ 117,50
600532-R	32	425	17.5	12.5	62.5	63.0	8.7	1080	€ 137,00



Chaves de Boca/Luneta com Roquete

Chaves de B/L em polegadas com roquete reversível 72 dentes, 13° de inclinação. Aço-vanádio cromado, acabamento acetinado. DIN 3113A.

nºStock	Medida	L mm	H1 mm	H2 mm	D1 mm	D2 mm	T mm	Peso g	Preço
600110-R	5/16"	140	6.5	4.6	16.6	16.7	3.0	30	€ 19,80
600112-R	3/8"	159	7.3	5.3	20.0	20.8	3.4	50	€ 21,00
600114-R	7/16"	165	7.7	5.6	21.8	23.0	3.7	70	€ 22,30
600116-R	1/2"	178	8.6	6.4	24.7	27.1	4.1	100	€ 25,00
600118-R	9/16"	191	9.0	6.8	27.0	29.2	4.4	120	€ 26,00
600120-R	5/8"	208	9.9	7.2	30.0	33.4	4.7	170	€ 30,00
600122-R	11/16"	226	10.3	7.7	31.8	35.5	5.1	200	€ 30,00
600124-R	3/4"	248	11.2	8.8	33.8	39.7	5.6	320	€ 33,00
600126-R	13/16"	290	13.0	9.0	40.0	46.0	6.0	360	€ 44,00
600128-R	7/8"	290	13.0	9.0	40.0	46.0	6.0	510	€ 44,00

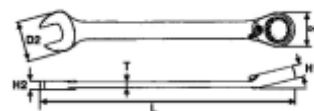

Chaves B/L c/ Roquete Fléxivel

Chaves de Boca/Luneta com Roquete Flexível

Chaves métricas de B/L com roquete flexível 180°. Aço-vanádio cromado, acabamento acetinado.

nºStock	Medida	L mm	H1 mm	H2 mm	D1 mm	D2 mm	T mm	Peso g	Preço
600507-RF	7	127	6.8	4.0	17	17.6	2.8	50	€ 22,60
600508-RF	8	127	6.8	4.0	17	17.6	2.8	50	€ 22,60
600509-RF	9	131	7.2	4.4	19	19.8	2.9	50	€ 22,80
600510-RF	10	136	7.6	4.8	20	22.0	3.3	60	€ 23,70
600511-RF	11	141	8.0	5.2	21	24.1	3.6	60	€ 24,00
600512-RF	12	147	8.5	5.5	23	25.9	3.9	80	€ 26,00
600513-RF	13	154	9.0	5.8	25	27.3	4.0	100	€ 27,00
600514-RF	14	160	9.3	6.2	27	30.6	4.3	120	€ 28,30
600515-RF	15	169	9.7	6.5	28	32.2	4.3	120	€ 28,30
600516-RF	16	179	10.2	6.8	30	33.7	4.7	160	€ 28,60
600517-RF	17	190	10.6	7.2	32	36.6	5.0	190	€ 31,00
600518-RF	18	203	11.0	7.7	33	38.4	5.2	190	€ 32,80
600519-RF	19	215	11.5	8.2	34	40.2	5.5	200	€ 33,60



Chaves B/L c/ Roquete rev.

6508-RSMM | € 147,00

Jogo 8 chaves métricas de B/L com roquete 72 dentes. Fornecido em estojo. Aço-vanádio cromado, acabamento acetinado.



Chaves boca/luneta	8, 10, 11, 12, 13, 14, 17, 19mm
--------------------	---------------------------------

6512-RSMM | € 178,00

Jogo 12 chaves métricas de B/L com roquete 72 dentes. Fornecido em estojo. Aço-vanádio cromado, acabamento acetinado.



Chaves boca/luneta	8, 9, 10, 11, 12, 13, 14, 15, 16, 17, 18, 19mm
--------------------	--

Chaves de Boca/Luneta com Roquete

Chaves métricas B/L com roquete 72 dentes. Aço-vanádio cromado, acabamento acetinado. DIN 899.



nºStock	Medida	L mm	A mm	B mm	C mm	D mm	H mm	T mm	Peso g	Preço
600508-RS	8	111.0	19.6	17.0	4.0	6.8	8.0	2.8	30	€ 18,40
600509-RS	9	123.0	20.8	19.0	4.4	7.2	9.0	2.9	41	€ 18,60
600510-RS	10	131.0	22.0	20.0	4.8	7.6	9.5	3.3	48	€ 19,20
600511-RS	11	147.0	24.2	21.0	5.2	8.0	10.0	3.6	62	€ 19,50
600512-RS	12	155.0	25.7	23.0	5.5	8,5	11.0	3.9	78	€ 20,00
600513-RS	13	164.0	27.2	25.0	5.8	8.9	12.0	4.0	88	€ 21,00
600514-RS	14	182.0	30.8	27.0	6.2	9.3	13.0	4.3	112	€ 23,80
600515-RS	15	192.0	32.4	28.0	6.5	9.7	13.6	4.5	123	€ 25,30
600516-RS	16	202.0	34.0	30.0	6.8	10.2	14.4	4.7	144	€ 27,30
600517-RS	17	223.0	37.7	32.0	7.2	10.6	15.3	5.0	192	€ 29,00
600518-RS	18	234.0	39.3	33.0	7.7	11.0	16.2	5.2	207	€ 31,00
600519-RS	19	246.0	40.8	34.0	8.2	11.5	17.0	5.5	233	€ 31,80
600520-RS	20	285.0	46.0	42.0	10.0	13.0	18.8	6.4	385	€ 33,40
600521-RS	21	285.0	46.0	42.0	10.0	13.0	18.8	6.4	385	€ 34,30
600522-RS	22	285.0	46.0	42.0	10.0	13.0	18.8	6.4	387	€ 35,40
600524-RS	24	325.0	51.5	47.5	11.0	14.5	20.6	7.0	511	€ 36,80



Chaves Boca/Luneta Compactas

Chaves métricas boca/luneta, com 15° de inclinação. Aço-vanádio cromado, acabamento acetinado. DIN 3113A.

nºStock	Medida	L mm	H1 mm	H2 mm	D1 mm	D2 mm	T mm	Peso g	Preço
6005M10-RS	10	95	7.0	5.1	16.2	21.9	3.4	30	€ 15,30
6005M11-RS	11	100	7.8	5.9	17.9	23.8	4.0	42	€ 15,60
6005M12-RS	12	105	8.2	6.6	19.1	24.7	4.2	48	€ 16,20
6005M13-RS	13	110	8.8	6.7	19.3	27.1	5.0	55	€ 17,00
6005M14-RS	14	115	9.1	7.4	21.8	28.9	5.1	66	€ 17,70
6005M15-RS	15	120	9.2	7.5	22.6	31.1	5.1	71	€ 18,10
6005M16-RS	16	125	9.8	8.1	23.6	33.0	5.6	87	€ 18,90
6005M17-RS	17	130	10.3	8.3	25.9	36.0	5.6	105	€ 20,00
6005M18-RS	18	135	11.0	8.7	27.2	36.8	5.8	118	€ 21,00
6005M19-RS	19	140	11.2	9.4	28.7	38.1	6.0	130	€ 22,00

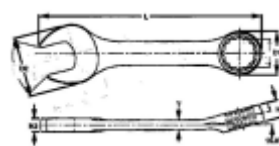

Chaves Aperto flexíveis

Chaves Flexíveis

Chaves flexíveis 90°. Aço-vanádio cromado, acabamento acetinado.

nºStock	Medida	L mm	D1 mm	D2 mm	W mm	T mm	Peso g	Preço
650809	8x9	192	12.2	13.5	10.0	4.6	95	€ 15,40
651011	10x11	200	15.5	16.9	10.0	4.6	105	€ 17,00
651013	10x13	213	14.5	18.2	12.5	5.0	140	€ 18,00
651213	12x13	218	18.2	19.2	12.5	5.0	150	€ 18,60
651415	14x15	243	20.5	21.7	14.0	5.8	215	€ 21,90
651617	16x17	275	23.0	24.2	15.0	6.5	300	€ 23,50
651819	18x19	284	25.5	26.7	16.0	7.5	382	€ 27,00

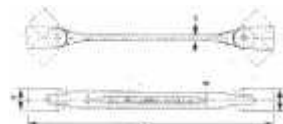

nºStock	Medida	L mm	D1 mm	D2 mm	W mm	T mm	Peso g	Preço
611214	3/8"x7/16"	200	15.5	16.9	10.0	4.6	105	€ 17,70
611618	1/2"x9/16"	218	18.2	19.2	12.5	5.0	150	€ 20,20
612022	5/8"x11/16"	275	23.0	24.2	14.0	6.5	300	€ 26,30



Chaves Flexíveis

Chaves flexíveis 1/4"-90°. Aço-vanádio cromado, acabamento acetinado.

nºStock	Medida	L mm	D1 mm	D2 mm	W mm	T mm	Peso g	Preço
691406	1/4" HEX x 1/4" M	196	14.5	14.5	10.0	4.6	102	€ 19,30



Chaves Anel c/ roquete

Chaves Roquete

Chaves roquete, reversíveis, inclinação 25°. Aço-vanádio cromado, acabamento acetinado.

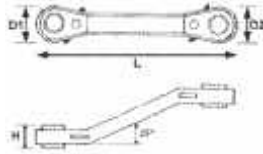

nºStock	Medida	L mm	H mm	D1 mm	D2 mm	Peso g	Preço
680608	6x8	112	8.0	20.0	20.0	63	€ 9,10
680709	7x9	133	8.4	21.0	23.0	81	€ 10,90
681013	10x13	163	10.2	26.0	30.0	149	€ 14,50
681214	12x14	172	10.2	30.0	32.0	169	€ 14,90
681719	17x19	203	11.0	37.0	40.0	254	€ 17,40
682122	21x22	235	11.4	41.0	45.0	290	€ 19,00

Chaves Roquete TX-E

Chaves roquete, reversíveis, inclinação 25°. Aço-vanádio cromado, acabamento acetinado.

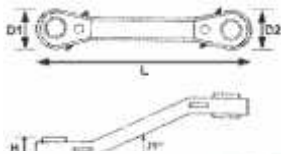

nºStock	Medida	L mm	H mm	D1 mm	D2 mm	Peso g	Preço
680607-E	E6xE7	112	8.0	20.0	20.0	66	€ 13,00
680810-E	E8xE10	133	8.2	21.0	23.0	84	€ 14,90
681112-E	E11xE12	140	8.2	23.0	26.0	95	€ 15,90
681416-E	E14xE16	172	10.2	30.0	32.0	174	€ 18,80
68182-0E	E18xE20	203	11.5	37.0	40.0	280	€ 20,80
682224-E	E22xE24	235	11.5	41.0	44.0	330	€ 22,60

6503-RX | € 107,00

Jogo 3 chaves roquete 4 em 1, com roquete reversível. Fornecido em estojo.



Chaves t/luneta 8x9 + 10x11, 12x13 + 14x15, 16x17 + 18x19mm

nºStock	Medida	L mm	D1 mm	D2 mm	Peso g	Preço
60050811-RX	8x9+10x11	150	19.2	22.0	13.5	€ 39,00
60051215-RX	12x13+14x15	190	25.5	28.0	18.4	€ 43,40
60051619-RX	16x17+18x19	320	31.7	34.0	20.8	€ 48,70

Chaves Roquete Duplo

Roquete Dupla Face

Roquete dupla face reversível, com curvatura, para parafusos de andaimes. Aço-vanádio, acabamento acetinado.



nºStock	Medida mm	L	A mm	B mm	C mm	D mm	Peso g	Preço
PGW-1719	17 x 19	315	42	50	26.0	26.3	450	€ 34,40
PGW-1922	19 x 22	315	42	50	26.0	29.5	450	€ 34,40
PGW-1924	19 x 24	315	42	50	26.0	32.0	469	€ 34,60
PGW-2124	21 x 24	315	42	50	28.0	32.0	462	€ 39,00
PGW-2430	24 x 30	450	63	63	32.0	40.0	1,33	€ 59,00
PGW-2730	27 x 30	366	65	63	36.6	40.0	1.35	€ 62,00



Chaves t/ Anel aberto

Chaves de Anel Aberto

Chaves de anel aberto com sistema de roquete.

nºStock	Medida mm	L mm	D mm	H1 mm	H2 mm	Peso g	Preço
600813	13	141	27.5	7.2	8.0	92	€ 36,00
600814	14	191	35.7	10.0	9.0	165	€ 44,00
600816	16	191	35.7	10.0	9.0	165	€ 44,00
600817	17	191	35.7	10.0	9.0	180	€ 44,00
600819	19	191	35.7	10.0	9.0	225	€ 45,00
600822	22	233	40.7	13.0	12.0	294	€ 53,00
600824	24	235	43.2	13.0	12.0	300	€ 61,00
600827	27	325	54.2	14.1	14.4	625	€ 82,70
600830	30	325	56.4	15.9	14.4	610	€ 85,00
600832	32	325	58.5	15.9	14.4	625	€ 88,00



Chaves Stylson

Chaves Stylson

Chaves Stylson com cabo em alumínio.

nºStock	Capacidade mm polegada	Comprimento mm polegada	Peso g	Preço
PWC-12	39 1 5/16"	300 12		€ 28,50
PWC-14	47 1 7/8"	350 14		€ 38,10
PWC-18	63 2 1/2"	450 18		€ 52,60
PWC-24	76 3"	600 24		€ 84,90
PWC-36	127 5"	900 36		€ 145,00



Chaves de Unha

Chaves de Unha

Chaves de unha articulada. Aço-vanádio cromado. DIN 1804.

nºStock	Capacidade mm polegadas	Comprimento mm polegadas	Peso g	Preço
HP101	19 - 50 3/4" - 2"	145 5 3/4"	122	€ 22,80
HP102	32 - 75 1 1/4" - 3"	178 7"	234	€ 36,00
HP103	50 - 120 2" - 4 3/4"	247 9 3/4"	447	€ 44,30

nºStock	Pino	Capacidade mm polegada	Comprimento mm polegada	Peso g	Preço
HP2014	4	19 - 50 3/4" - 2"	145 5 3/4"	122	€ 29,80
HP2015	5	19 - 50 3/4" - 2"	145 5 3/4"	122	€ 29,80
HP2025	5	32 - 75 1 1/4" - 3"	178 7"	227	€ 41,30
HP2026	6	32 - 75 1 1/4" - 3"	178 7"	227	€ 42,00
HP2036	6	50 - 120 2" - 4 3/4"	247 9 3/4"	451	€ 49,50
HP2038	8	50 - 120 2" - 4 3/4"	247 9 3/4"	451	€ 49,50



Chaves Crescentes

4003-J | € 31,00

Chave crescente 8" com abertura até 32mm, extremidade para aperto de canos M2 a M8. Aço-vanádio com acabamento fosfatado.



Chaves Crescentes

Chaves crescentes. Aço-vanádio com acabamento fosfatado. ISO 6787-1982, ASME B.107.8M-1996, BS 6333-1995, DIN 3117-1988, JIS B4604-1976.



nºStock	L mm	L	Capacidade mm polegada	T mm	D mm	ISO Nm	Peso g	Preço
4001	100	4	17 11/16"	14	31	33	50	€ 15,40
4002	150	6	24 15/16"	19	44	85	140	€ 15,90
4003	200	8	28 1 1/8"	26	57	180	260	€ 19,20
4004	250	10	33 1 1/4"	31	68	320	440	€ 24,10
4005	300	12	38 1 1/2"	32	80	515	660	€ 30,20
4006	375	15	50 1 5/8"	44	100	920	1200	€ 60,30
4007	450	18	60 2 3/8"	53	122	-	2000	€ 101,00
4008	600	24	70 2 3/4"	62	144	-	3700	€ 223,00

Chaves Crescentes - Cabo Bí-material

Chaves crescentes com cabo bi-material. Aço-vanádio com acabamento fosfatado. ISO 6787-1982, ASME B.107.8M-1996, BS 6333-1995, DIN 3117-1988, JIS B4604-1976.



nºStock	L mm	L	Capacidade mm polegada	T mm	D mm	ISO Nm	Peso g	Preço
4002-IQ	157	6	24 15/16"	20.0	52	85	140	€ 20,00
4003-IQ	206	8	28 1 1/8"	25.3	62	180	260	€ 23,80
4004-IQ	255	10	33 1 1/4"	29.5	72	320	440	€ 29,50
4005-IQ	305	12	38 1 1/2"	32.2	83	515	660	€ 36,70
4006-IQ	380	15	50 1 5/8"	44.7	108	920	1200	€ 76,00

Chaves Crescente - Maior Abertura

Chaves crescentes, com cabo ergonómico bi-material. Aço-vanádio com acabamento fosfatado. ISO6787-1982, ASME B.107.8-1996, BS6333-1995, DIN3117-1988, JIS B4604-1976.



nºStock	L mm	L	Capacidade mm polegada	T mm	D mm	Peso g	Preço
4002-WT	172	7	34.0 1 3/8"	30.0	63.5	185	€ 27,20
4003-WT	221	8	38.6 1 1/2"	34.1	72.1	260	€ 31,20
4004-WT	275	10	50 2"	41.0	92.1	440	€ 40,70
4005-WT	317	12	60 2 3/8"	55.7	110.5	660	€ 65,00



Chaves de Ajuste

Chaves de Ajuste de Dobradiças

Chaves para ajuste de dobradiças exteriores de portas e janelas.

nºStock	Comprimento mm	Medida mm	Peso g	Preço
DHW-1300	220	13	170	€ 13,50
DHW-1417	290	14 x 17	310	€ 20,70
DHW-1922	300	19 x 22	440	€ 23,40



Chaves aperto Tubos

BWT-406 | € 29,20

Chaves de tubos telescópica com comprimento de 275 a 400mm , boca serrilhada de encaixe rápido, para tubos de 32 a 48mm. Ideal para apertar tubos em locais de difícil acesso ex: lavatórios, bancas, etc.



TENGOOLS

**CHAVE AJUSTÁVEL
QUE EXCEDE
TODOS OS
REQUERIMENTOS**

FERRAMENTAS VENCEDORAS DE TESTE PARA PROFISSIONAIS



Vencedora!



Chaves de Inserção de Boca

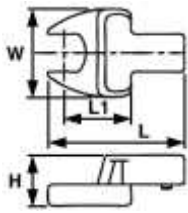

nºStock	Medida mm	encaixe mm	W mm	H mm	L mm	L1 mm	Peso g	Preço
690510	10	9x12	30	15	39	18	42	€ 17,30
690511	11	9x12	30	15	39	18	43	€ 17,30
690512	12	9x12	30	16	40	18	48	€ 17,30
690513	13	9x12	30	16	42	20	52	€ 18,30
690514	14	9x12	35	17	42	20	59	€ 18,30
690515	15	9x12	35	17	43	20	59	€ 18,30
690516	16	9x12	38	18	43	20	67	€ 18,30
690517	17	9x12	38	18	44	22	67	€ 18,30
690518	18	9x12	42	18	46	22	75	€ 18,30
690519	19	9x12	42	18	46	22	75	€ 18,30

nºStock	Medida mm	encaixe mm	W mm	H mm	L mm	L1 mm	Peso g	Preço
690613	13	14x18	35	21	63	32	148	€ 19,30
690614	14	14x18	35	22	63	32	154	€ 19,30
690615	15	14x18	35	23	64	32	154	€ 19,30
690616	16	14x18	38	23	64	32	173	€ 19,30
690617	17	14x18	38	23	64	32	173	€ 19,30
690618	18	14x18	42	24	65	32	192	€ 19,30
690619	19	14x18	42	25	65	32	193	€ 19,30
690621	21	14x18	50	25	66	32	217	€ 20,50
690622	22	14x18	53	26	66	32	222	€ 20,50
690624	24	14x18	53	26	67	32	225	€ 20,50
690626	26	14x18	60	27	70	33	273	€ 20,50
690627	27	14x18	60	27	70	34	281	€ 20,50
690629	29	14x18	66	28	74	36	312	€ 20,50
690630	30	14x18	66	28	74	36	312	€ 20,50
690632	32	14x18	66	29	77	38	322	€ 20,50
690634	34	14x18	73	29	82	43	345	€ 22,80
690636	36	14x18	73	29	82	42	368	€ 22,80
690638	38	14x18	73	29	82	41	366	€ 23,70
690640	40	14x18	82	29	83	42	383	€ 23,70
690641	41	14x18	82	29	84	42	400	€ 27,80
690642	42	14x18	82	29	83	42	410	€ 27,80
690644	44	14x18	91	29	86	41	423	€ 31,00
690646	46	14x18	91	29	86	43	436	€ 31,00



para usar com ref-1292P912 e ref-1292P418



Chaves de Inserção Luneta

nºStock	Medida mm	encaixe mm	W mm	H mm	L mm	L1 mm	Peso g	Preço
690710	10	9x12	26.5	16	45	18	52	€ 17,70
690711	11	9x12	26.5	16	45	18	50	€ 17,70
690712	12	9x12	26.7	16	46	18	48	€ 17,70
690713	13	9x12	27.2	16	49	20	60	€ 18,30
690714	14	9x12	27	18	50	20	64	€ 18,60
690715	15	9x12	27	18	50	20	64	€ 18,60
690716	16	9x12	27	18	50	20	62	€ 18,60
690717	17	9x12	28.6	18	54	22	74	€ 18,60
690718	18	9x12	28.6	18	54	22	74	€ 19,30
690719	19	9x12	28.6	18	54	22	68	€ 19,30

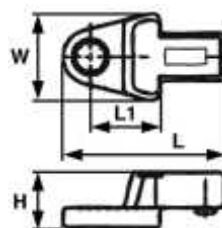

nºStock	Medida mm	encaixe mm	W mm	H mm	L mm	L1 mm	Peso g	Preço
690813	13	14x18	38	22	72	32	200	€ 19,90
690814	14	14x18	38	22	72	32	200	€ 19,90
690815	15	14x18	38	22	73	32	194	€ 19,90
690816	16	14x18	38	24	73	32	204	€ 19,90
690817	17	14x18	38	24	73	32	194	€ 20,50
690818	18	14x18	44	24	75	32	234	€ 20,80
690819	19	14x18	44	24	75	32	230	€ 20,80
690821	21	14x18	41	26	76	32	236	€ 21,70
690822	22	14x18	42	25	77	32	250	€ 21,70
690824	24	14x18	42	26	78	32	254	€ 21,70
690826	26	14x18	42	26	78	33	240	€ 22,60
690827	27	14x18	43.4	27	82	34	280	€ 22,60
690829	29	14x18	43.3	28	85	36	306	€ 22,60
690830	30	14x18	47.3	28	87	36	328	€ 22,60
690832	32	14x18	47.3	29	87	38	312	€ 22,60
690834	34	14x18	50	29	90	43	324	€ 25,00
690836	36	14x18	52	29	91	42	316	€ 25,50
690838	38	14x18	54.6	31	94	41	342	€ 26,70
690840	40	14x18	54.6	30	93	42	367	€ 28,50
690841	41	14x18	60	32	99	42	376	€ 30,30
690842	42	14x18	60	32	99	42	376	€ 30,30
690844	44	14x18	60	31	99	41	386	€ 35,00
690846	46	14x18	60	32	103	43	396	€ 35,00



para usar com ref-1292P912 e ref-1292P418



Chaves Aperto p^a porcas

Chaves de Aparafusar Porcas

Chaves porcas 6 pontos, com cabo ergonómico bi-material. DIN 3125.



nºStock	Medida mm	Haste mm	Comp. mm	Peso g	Preço
MDN-505	5.0	125	234	91	€ 10,70
MDN-5055	5.5	125	234	93	€ 10,80
MDN-506	6.0	125	234	93	€ 10,90
MDN-507	7.0	125	234	98	€ 11,00
MDN-508	8.0	125	234	102	€ 11,30
MDN-510	10.0	125	242	130	€ 11,50
MDN-511	11.0	125	242	153	€ 12,00
MDN-512	12.0	125	242	153	€ 12,50
MDN-513	13.0	125	242	160	€ 12,80



Chaves de Aparafusar Porcas cabo em T

Chaves porcas 6 pontos, com cabo ergonómico bi-material. DIN 3125.



nºStock	Medida mm	Comprimento mm	Preço
MDN-T-505	5.0	288	€ 12,00
MDN-T-5055	5.5	288	€ 11,90
MDN-T-506	6.0	288	€ 11,90
MDN-T-507	7.0	288	€ 12,50
MDN-T-508	8.0	288	€ 13,00
MDN-T-509	9.0	288	€ 13,50
MDN-T-510	10.0	288	€ 13,80
MDN-T-511	11.0	288	€ 14,40
MDN-T-512	12.0	288	€ 15,40
MDN-T-513	13.0	288	€ 16,00
MDN-T-514	14.0	288	€ 17,00

Chaves de Porcas

Aço-vanádio cromado, acabamento acetinado. DIN 3113A.



nºStock	Medida	L mm	H mm	D1 mm	D2 mm	C1 mm	C2 mm	T mm	Peso g	Preço
641011	10x11	152.4	7.9	21.4	23.0	7.0	8.2	4.3	60	€ 5,90
641213	12x13	178.6	10.0	25.0	27.4	9.0	10.3	5.7	113	€ 6,70
641314	13x14	178.6	13.1	25.0	27.4	14.3	15.1	5.7	113	€ 8,70
641617	16x17	196.0	15.1	29.9	31.9	15.4	17.0	6.4	113	€ 10,00
641922	19x22	207.7	17.0	34.2	38.2	18.9	20.0	7.4	113	€ 12,00

nºStock	Medida	L mm	H mm	D1 mm	D2 mm	C1 mm	C2 mm	T mm	Peso g	Preço
661416	7/16"x1/2"	158.8	11.9	23.0	24.3	8.2	9.0	5.5	113	€ 6,45



Chaves de Pancada

nºStock	Medida	L mm	A mm	B mm	C mm	D mm	L3 mm	H mm	Peso g	Preço
902024	24	178	52.3	14.5	23.4	7.8	107.5	10.2	250	€ 26,00
902027	27	180	55.0	15.5	25.2	8.6	107.5	10.2	350	€ 26,00
902030	30	190	60.4	16.2	30.0	9.5	107.5	15.6	500	€ 31,00
902032	32	190	60.5	16.7	30.5	9.8	108.0	14.8	480	€ 33,00
902036	36	214	71.3	17.0	35.0	9.8	118.0	14.9	700	€ 42,00
902038	38	215	72.0	17.3	37.0	9.8	118.0	16.2	750	€ 47,00
902041	41	233	82.4	19.2	39.3	12.0	127.6	18.3	900	€ 51,00
902046	46	252	93.2	20.4	44.2	12.8	135.6	18.8	1300	€ 66,00
902050	50	275	104.0	21.3	48.0	13.2	140.8	19.6	1500	€ 90,00
902055	55	295	114.4	23.8	54.2	15.3	158.6	24.2	1950	€ 98,00
902060	60	315	125.1	26.6	58.8	17.3	166.2	24.8	2500	€ 141,00
902065	65	340	138.0	28.8	55.0	17.6	175.0	25.1	3300	€ 150,00
902070	70	370	152.7	30.6	69.0	19.0	190.0	32.0	4300	€ 185,00
902075	75	370	152.7	31.0	69.0	19.0	190.0	33.4	4700	€ 193,00
902080	80	397	175.0	33.2	71.5	19.0	180.0	46.6	5500	€ 375,00
902085	85	397	175.0	33.2	71.5	19.0	180.0	46.6	5200	€ 449,00
902090	90	444	191.0	34.7	80.0	19.6	190.0	51.7	7000	€ 490,00
902095	95	444	191.3	36.3	80.0	21.0	190.0	52.2	6600	€ 603,00
902100	100	488	225.0	42.3	85.0	21.8	205.0	55.5	10500	€ 695,00

Chaves de Pancada - Boca

Chaves de pancada impacto com boca.
DIN3126. Aço-molibdênio.

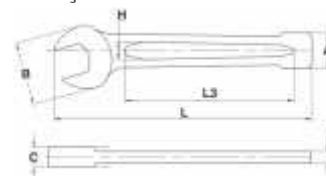

nºStock	Medida	L mm	A mm	B mm	C mm	D mm	L3 mm	H mm	Peso g	Preço
903024	24	162	42.8	14.7	24.6	7.9	93.9	9.4	248	€ 25,00
903027	27	180	45.2	15.4	25.0	8.6	107.3	9.4	260	€ 28,00
903030	30	190	50.6	16.2	29.4	9.3	107.3	11.5	376	€ 32,00
903032	32	190	53.7	16.4	31.7	10.0	107.3	12.3	480	€ 35,00
903036	36	205	58.3	17.9	35.6	10.5	107.3	13.3	520	€ 41,00
903038	38	229	63.7	19.9	36.9	12.0	130.3	13.3	660	€ 47,00
903041	41	230	63.9	19.9	37.4	12.3	130.3	13.3	780	€ 51,00
903046	46	240	73.5	21.8	43.9	12.5	130.9	14.5	1150	€ 64,00
903050	50	255	78.5	23.2	46.3	13.0	134.5	17.0	1070	€ 67,50
903055	55	266	85.1	25.0	49.4	15.5	141.2	19.3	1350	€ 78,30
903060	60	280	91.7	26.5	52.2	16.5	150.0	22.7	1650	€ 89,80
903065	65	298	100.0	27.5	54.0	16.5	150.0	23.2	1890	€ 109,00
903070	70	330	109.5	32.8	62.0	20.0	165.0	24.6	2850	€ 151,00
903075	75	330	110.0	32.8	62.2	20.0	154.0	24.6	2700	€ 154,00
903080	80	355	129.4	37.0	82.3	23.8	170.0	40.0	3400	€ 321,00
903085	85	355	129.5	37.3	82.0	23.4	170.0	40.0	4100	€ 370,00
903090	90	395	143.5	40.0	72.7	24.2	170.0	47.5	5200	€ 456,00
903095	95	390	144.0	37.1	72.8	20.8	165.0	47.5	5100	€ 493,00
903100	100	420	155.0	41.6	80.0	23.6	175.0	50.0	6700	€ 575,00

Chaves de Pancada - Luneta

Chaves de pancada impacto com luneta.
DIN3126. Aço-molibdênio.

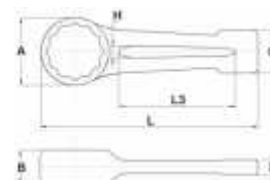

1476-NMM | € 12,70

Jogo retráctil 7 chaves Umbrako. Aço-vanádio cromado. Suporte em alumínio.

Chaves umbrako 1.5, 2.0, 2.5, 3.0, 4.0, 5.0, 6.0, 7.0, 8.0, 10.0mm

**1476-NAF | € 12,70**

Jogo retráctil 7 chaves Umbrako. Aço-vanádio cromado. Suporte em alumínio.

Chaves umbrako 1/16", 5/64", 3/32", 1/8", 5/32", 3/16", 7/32"

**1471-MM | € 7,60**

Jogo retráctil 7 chaves Umbrako. Aço-vanádio cromado. Suporte metálico com conector para fio de segurança.

Chaves umbrako 1.5, 2.0, 2.5, 3.0, 4.0, 5.0, 6.0mm

**1471-AF | € 7,60**

Jogo retráctil 7 chaves Umbrako. Aço-vanádio cromado. Suporte metálico com conector para fio de segurança.

Chaves umbrako 1/16", 5/64", 3/32", 1/8", 5/32", 3/16", 7/32"

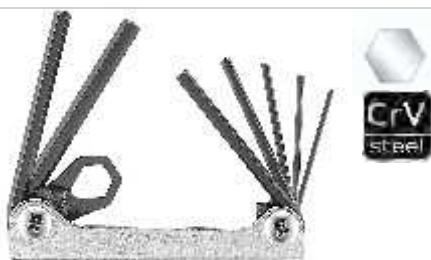
**1476-NMM1 | € 13,80**

Jogo retráctil 7 chaves Umbrako. Aço-vanádio cromado. Suporte em alumínio.

Chaves umbrako 2.5, 3.0, 4.0, 5.0, 6.0, 8.0, 10.0mm

**1477-NX | € 21,50**

Jogo retráctil 8 chaves. Aço-vanádio cromado. Suporte em alumínio.

Chaves hex 4.0, 5.0, 6.0mm, TX25, TX30, PH1, PZ2, fendas 1.0x5.5mm

**1471-MMA | € 11,80**

Jogo retráctil 7 chaves Umbrako. Aço-vanádio cromado. Suporte metálico com conector para fio de segurança.

Chaves umbrako 2.5, 3.0, 4.0, 5.0, 6.0, 8.0, 10.0mm

**1471-AFA | € 12,00**

Jogo retráctil 6 chaves Umbrako. Aço-vanádio cromado. Suporte metálico com conector para fio de segurança.

Chaves umbrako 1/8", 5/32", 3/16", 1/4", 5/16", 3/8"



1473 | € 30,80

Jogo retrátil 11 chaves para bicicleta. Suporte em alumínio.



Chaves

hex 4.0, 5.0, 6.0mm, TX25, TX30, PH2, fendas 1.0x5.5mm
Medidor pneus, e ch reparação correntes.

1425 | € 6,40

Jogo 10 chaves Umbrako com anél porta chaves.
Aço-vanádio cromado.

Chaves umbrako 1.5, 2.0, 2.5, 3.0, 4.0, 5.0, 6.0, 7.0, 8.0, 10.0mm

Série ref-3105...



1424 | € 6,00

Jogo 10 chaves Umbrako com anél porta chaves.
Aço-vanádio cromado.

Chaves umbrako 1/16", 5/64", 3/32", 1/8", 5/32", 3/16", 7/32", 1/4", 5/16", 3/8"

Série ref-3101...



1477-MM | € 5,20

Jogo 7 chaves MINI Umbrako. Aço-vanádio cromado.
Fornecido em suporte plástico.

Chaves umbrako 0.9, 1.3, 1.5, 2, 2.5, 3, 4mm

Série ref-3105...



1477-AF | € 5,20

Jogo 7 chaves MINI Umbrako. Aço-vanádio cromado.
Fornecido em suporte plástico.

Chaves umbrako 0.028, 0.035, 0,050, 1/16, 5/64, 8/32, 7/64"

Série ref-3101...



1479-MMR | € 9,80

Jogo 9 chaves Umbrako. Aço-vanádio cromado.
Fornecido em suporte plástico desdobrável.



Chaves umbrako 1.5, 2.0, 2.5, 3.0, 4.0, 5.0, 6.0, 8.0, 10.0mm

Série ref-3105...



1479-MMRL | € 14,80

Jogo 9 chaves **longas** Umbrako. Aço-vanádio cromado.
Fornecido em suporte plástico desdobrável.

Chaves umbrako 1.5, 2.0, 2.5, 3.0, 4.0, 5.0, 6.0, 8.0, 10.0mm

Série ref-3205...

**Milímetros****Chaves Umbrako****Polegadas**

nºStock	Medida mm	Braço curto mm	Braço longo mm	Preço
3105007	0.7	8	35	€ 0,36
3105009	0.9	10	38	€ 0,36
3105013	1.3	12	41	€ 0,36
3105015	1.5	14	45	€ 0,36
310502	2.0	16	50	€ 0,36
3105025	2.5	18	56	€ 0,36
310503	3.0	20	63	€ 0,36
310504	4.0	25	70	€ 0,60
3105045	4.5	26	75	€ 0,60
310505	5.0	28	80	€ 0,90
3105055	5.5	30	85	€ 0,90
310506	6.0	32	90	€ 0,90
310507	7.0	34	95	€ 1,70
310508	8.0	36	100	€ 1,60
310509	9.0	38	106	€ 1,80
310510	10.0	40	112	€ 2,30
310511	11.0	42	118	€ 4,00
310512	12.0	45	125	€ 4,20
310514	14.0	56	140	€ 6,20
310516	16.0	60	152	€ 9,00
310517	17.0	63	160	€ 9,40
310518	18.0	66	159	€ 13,70
310519	19.0	70	180	€ 14,20
310522	22.0	80	200	€ 25,00
310527	27.0	100	250	€ 46,00
310532	32.0	125	315	€ 85,00
310536	36.0	140	355	€ 119,00



nºStock	Medida	Braço curto mm	Braço longo mm	Preço
310102	1/16"	14	44	€ 0,36
3101025	5/64"	15	48	€ 0,36
310103	3/32"	17	51	€ 0,36
3101035	7/64"	18	54	€ 0,36
310104	1/8"	19	57	€ 0,36
3101045	9/64"	20	60	€ 0,36
310105	5/32"	21	64	€ 0,60
310106	3/16"	24	70	€ 0,60
310107	7/32"	26	76	€ 0,70
310108	1/4"	28	83	€ 0,95
310110	5/16"	32	95	€ 1,35
310112	3/8"	35	108	€ 1,90
310114	7/16"	38	121	€ 3,80
310116	1/2"	41	133	€ 5,00

Milímetros Longas

3205015	1.5	14	90	€ 1,50
320502	2.0	16	100	€ 1,50
3205025	2.5	18	112	€ 1,80
320503	3.0	20	126	€ 1,90
320504	4.0	25	140	€ 2,10
320505	5.0	28	160	€ 2,50
320506	6.0	32	180	€ 2,90
320508	8.0	36	200	€ 3,90
320510	10.0	40	224	€ 5,40



1475 | € 12,60

Jogo 7 chaves Umbrako com ponta esférica. Aço-vanádio cromado. Fornevido em suporte plástico.



Chaves umbrako 2.5, 3.0, 4.0, 5.0, 6.0, 8.0, 10.0mm

Série ref-3105..BL.

1479-MM | € 17,70

Jogo 9 chaves Umbrako com ponta esférica. Aço-vanádio cromado. Fornevido em suporte plástico.



Chaves umbrako 1.5, 2.0, 2.5, 3.0, 4.0, 5.0, 6.0, 8.0, 10.0mm

Série ref-3105..BL.

1479-MMA | € 17,60

Jogo 9 chaves Umbrako com ponta esférica. Aço-vanádio cromado. Fornevido em suporte plástico.



Chaves umbrako 1.5, 2.0, 2.5, 3.0, 4.0, 5.0, 6.0, 7.0, 10.0mm

Série ref-3105..BL.

1474 | € 12,60

Jogo 7 chaves Umbrako com ponta esférica. Aço-vanádio cromado. Fornevido em suporte plástico.



Chaves umbrako 1/8", 5/32", 3/16", 7/32", 1/4", 5/16", 3/8"

Série ref-3101..BL.

1479-AF | € 18,20

Jogo 9 chaves Umbrako com ponta esférica. Aço-vanádio cromado. Fornevido em suporte plástico.



Chaves umbrako 5/64", 3/32", 1/8", 5/32", 3/16", 7/32", 1/4", 5/16", 3/8"

Série ref-3101..BL.



Chaves Umbrako Boleadas									
Milímetros					Polegadas				
nºStock	Medida	Braço curto mm	Braço longo mm	Preço	nºStock	Medida mm	Braço curto mm	Braço longo mm	Preço
3101025BL	5/64"	15	82	€ 1,90	3105015BL	1.5	17	76	€ 2,00
310103BL	3/32"	17	88	€ 2,30	310502BL	2.0	19	83	€ 2,00
310104BL	1/8"	19	96	€ 2,35	3105025BL	2.5	20	90	€ 2,00
310105BL	5/32"	21	105	€ 2,40	310503BL	3.0	22	99	€ 2,05
310106BL	3/16"	24	114	€ 2,60	310504BL	4.0	28	111	€ 2,35
310107BL	7/32"	26	124	€ 2,80	310505BL	5.0	32	126	€ 2,60
310108BL	1/4"	28	135	€ 3,00	310506BL	6.0	38	143	€ 2,95
310110BL	5/16"	32	151	€ 3,90	310507BL	7.0	34	144	€ 3,50
310112BL	3/8"	35	170	€ 4,90	310508BL	8.0	44	160	€ 3,95
					310510BL	10.0	50	180	€ 5,30
					310512BL	12.0	45	207	€ 9,60
					310514BL	14.0	56	230	€ 15,00
					310517BL	17.0	63	250	€ 23,00
					310519BL	19.0	70	280	€ 33,00



Aço cromo-vanádio (símbolo Cr-V ou CrV)

Frequentemente comercializado como "cromo vanádio" é um grupo de ligas de aço que incorporam carbono (0,50%), manganês (0,70-0,90%), silício (0,30%), cromo (0,80-1,10%) e vanádio (0,18%).

Cromo e vanádio tornam o aço mais adequado para endurecimento. O cromo também ajuda a resistir à abrasão, oxidação e corrosão.

Cromo e carbono podem melhorar a elasticidade.



Aço Chrome Molybdenum (símbolo Cr-MO)

O aço Cr-MO é de uma família de graus de aço SAE. Os elementos de liga incluem cromo e molibdênio.

Eles têm uma excelente relação resistência/peso e são consideravelmente mais fortes e duros do que o aço padrão, mas não são facilmente soldados, exigindo tratamento térmico antes e depois da soldagem para evitar fissuras a frio.

São usados nas ferramentas para quando se quer obter máxima performance.



1499-MM | € 20,40

Jogo 9 chaves Umbrako com ponta esférica. Liga de aço molibdénio
Fornecido em suporte plástico.

Chaves umbrako 1.5, 2.0, 2.5, 3.0, 4.0, 5.0, 6.0, 8.0, 10.0mm

Série ref-3905..BL.



nºStock	Medida mm	Braço curto mm	Braço longo mm	Preço
3905015BL	1.5	14	77	€ 2,10
390502BL	2.0	16	83	€ 2,10
3905025BL	2.5	18	90	€ 2,30
390503BL	3.0	20	98	€ 2,60
390504BL	4.0	25	106	€ 2,70
390505BL	5.0	28	118	€ 3,00
390506BL	6.0	32	137	€ 3,30
390508BL	8.0	36	156	€ 4,30
390510BL	10.0	40	170	€ 6,00

1479-MML | € 25,00

Jogo 9 chaves extra-longas Umbrako. Liga de aço molibdénio
Fornecido em suporte plástico desdobrável.

Chaves umbrako 1.5, 2.0, 2.5, 3.0, 4.0, 5.0, 6.0, 8.0, 10.0mm

Série ref-3908..BL.



nºStock	Medida mm	Braço curto mm	Braço longo mm	Preço
3908015BL	1.5	14	90	€ 2,10
390802BL	2.0	16	100	€ 2,10
3908025BL	2.5	18	112	€ 2,40
390803BL	3.0	20	126	€ 2,80
390804BL	4.0	25	140	€ 3,00
390805BL	5.0	28	160	€ 3,50
390806BL	6.0	32	180	€ 3,90
390808BL	8.0	36	200	€ 5,10
390810BL	10.0	40	224	€ 6,90

1499-AF | € 20,40

Jogo 9 chaves Umbrako com ponta esférica. Liga de aço molibdénio
Fornecido em suporte plástico.

Chaves umbrako 5/64", 3/32", 1/8", 5/32", 3/16", 7/32", 1/4", 5/16", 3/8"

Série ref-3901..BL.



nºStock	Medida	Braço curto mm	Braço longo mm	Preço
3901025BL	5/64"	15	82	€ 1,95
390103BL	3/32"	17	88	€ 2,10
390104BL	1/8"	19	96	€ 2,50
390105BL	5/32"	21	105	€ 2,50
390106BL	3/16"	24	114	€ 2,80
390107BL	7/32"	26	124	€ 2,95
390108BL	1/4"	28	135	€ 3,20
390110BL	5/16"	32	151	€ 4,00
390112BL	3/8"	35	170	€ 5,40



1476-NTX | € 18,70

Jogo retráctil 8 chaves Umbrako com ponta Torx.
Aço-vanádio cromado. Suporte em alumínio.

Chaves umbrako TX9, TX10, TX15, TX20, TX25, TX27, TX30, TX40

**1476-NTX1 | € 26,00**

Jogo retráctil 8 chaves Umbrako com ponta Torx esférica.
Aço-vanádio cromado. Suporte em alumínio.

Chaves umbrako TX9, TX10, TX15, TX20, TX25, TX27, TX30, TX40

**1476-NTX2 | € 17,50**

Jogo retráctil 8 chaves Umbrako com ponta Torx.
Liga de aço molibdénio. Suporte metálico com conector para fio de segurança.

Chaves umbrako TX9, TX10, TX15, TX20, TX25, TX27, TX30, TX40

**1487 | € 13,40**

Jogo 7 chaves Umbrako com ponta Torx. Aço-vanádio cromado.
Fornecido com anél porta chaves.

Chaves umbrako TX10, TX15, TX20, TX25, TX27, TX30, TX40

Série ref-3200...



Chaves umbrako TX8, TX9, TX10, TX15, TX20, TX25, TX27, TX30, TX40

Série ref-3200...

1479-TX | € 22,00

Jogo 9 chaves Umbrako com ponta Torx. Aço-vanádio cromado.
Fornecido em suporte plástico.

**1479-TX1 | € 30,10**

Jogo 9 chaves Umbrako com ponta Torx esférica. Aço-vanádio cromado.
Fornecido em suporte plástico.

Chaves umbrako TX8, TX9, TX10, TX15, TX20, TX25, TX27, TX30, TX40

Série ref-3200..BL.



Chaves Umbrako					TORX Boleadas					
TORX										
nºStock	Medida TX	Braço curto mm	Braço longo mm	Preço		nºStock	Medida TX	Braço curto mm	Braço longo mm	Preço
320008	8	16	80	€ 3,00		320008BL	8	16	80	€ 4,30
320009	9	16	83	€ 3,00		320009BL	9	16	83	€ 4,30
320010	10	17	86	€ 3,20		320010BL	10	17	86	€ 4,40
320015	15	18	90	€ 3,30		320015BL	15	18	90	€ 4,40
320020	20	19	95	€ 3,40		320020BL	20	19	95	€ 4,60
320025	25	20	100	€ 3,80		320025BL	25	20	100	€ 4,60
320027	27	22	105	€ 4,00		320027BL	27	22	105	€ 4,70
320030	30	24	114	€ 4,30		320030BL	30	24	114	€ 4,75
320040	40	26	124	€ 4,75		320040BL	40	26	124	€ 5,00
320045	45	29	133	€ 5,60		320045BL	45	29	133	€ 6,65
320050	50	32	152	€ 6,30		320050BL	50	32	152	€ 6,90



1499-TX | € 33,30

Jogo 9 chaves Umbrako com ponta Torx esférica. Liga de aço molibdénio. Fornecido em suporte plástico.



Chaves umbrako TX8, TX9, TX10, TX15, TX20, TX25, TX27, TX30, TX40



nºStock	Medida TX	Braço curto mm	Braço longo mm	Preço
390908BL	8	16	80	€ 3,60
390909BL	9	16	83	€ 3,60
390910BL	10	17	86	€ 3,80
390915BL	15	18	90	€ 3,90
390920BL	20	19	95	€ 4,10
390925BL	25	20	100	€ 4,50
390927BL	27	22	105	€ 4,70
390930BL	30	24	114	€ 4,90
390940BL	40	26	124	€ 3,30

1498-TPX | € 28,00

Jogo 9 chaves Umbrako com ponta Torx. Liga de aço molibdénio. Fornecido em suporte plástico.



Chaves umbrako TPX8, TPX9, TPX10, TPX15, TPX20, TPX25, TPX27, TPX30, TPX40



nºStock	Medida TX	Braço curto mm	Braço longo mm	Preço
390808TPX	8	16	80	€ 4,60
390809TPX	9	16	83	€ 4,60
390810TPX	10	17	86	€ 4,60
390815TPX	15	18	90	€ 4,60
390820TPX	20	19	95	€ 4,80
390825TPX	25	20	100	€ 4,80
390827TPX	27	22	105	€ 4,90
390830TPX	30	24	114	€ 4,90
390840TPX	40	26	124	€ 5,20



Chaves T Umbrako

Chaves T Umbrako. Punho ergonómico bi-material.

nºStock	Medida mm	Braço curto mm	Braço longo mm	Preço
5106025	2.5	15	100	€ 5,90
510603	3.0	15	100	€ 5,80
510604	4.0	15	100	€ 6,00
510605	5.0	18	150	€ 7,10
510606	6.0	18	150	€ 7,60
510607	7.0	18	150	€ 9,20
510608	8.0	18	190	€ 9,30



Chaves T Umbrako Boleadas

Chaves T Umbrako com ponta esférica.

Punho ergonómico bi-material.

nºStock	Medida mm	Braço curto mm	Braço longo mm	Preço
510502	2.0	12	100	€ 5,95
5105025	2.5	12	100	€ 5,95
510503	3.0	12	100	€ 5,95
510504	4.0	12	100	€ 6,25
510505	5.0	15	150	€ 7,30
510506	6.0	15	150	€ 7,80
510507	7.0	15	150	€ 9,70
510508	8.0	18	190	€ 9,90
510510	10.0	20	200	€ 15,40
510512	12.0	20	200	€ 17,60



nºStock	Medida	Braço curto mm	Braço longo mm	Preço
510103	3/32"	12	100	€ 6,00
510104	1/8"	12	100	€ 6,30
510105	5/32"	12	100	€ 6,70
510106	3/16"	12	100	€ 7,20
510107	7/32"	15	150	€ 8,10
510108	1/4"	15	150	€ 9,70
510110	5/16"	15	150	€ 10,00



nºStock	Medida TX	Braço curto mm	Braço longo mm	Preço
520009	TX/TPX9	12	100	€ 5,90
520010	TX/TPX10	12	100	€ 5,90
520015	TX/TPX15	12	100	€ 5,90
520020	TX/TPX20	12	100	€ 5,90
520025	TX/TPX25	15	150	€ 6,80
520027	TX/TPX27	15	150	€ 6,80
520030	TX/TPX30	15	150	€ 7,70
520040	TX/TPX40	18	190	€ 8,25
520045	TX/TPX45	20	200	€ 8,90
520050	TX/TPX50	20	200	€ 11,50
520055	TX/TPX55	20	200	€ 14,20

Chaves T Umbrako TX/TPX

Chaves T Umbrako com pontas Torx e Torx com furo.

Punho ergonómico bi-material.



Chave Dinamométrica 1/4"

Chave de parafusos dinamométrica com quadra de 1/4". Alcance 1 - 5 Nm.



nºStock	Descrição	Alcance Nm	Preço
1492-TSD	chave parafusos dinamométrica	1-5	€83,00

Chave Dinamométrica 1/4"

Chave de parafusos dinamométrica com quadra de 1/4". Alcance 1 - 5 Nm.



nºStock	Descrição	Alcance Nm	Preço
1492-SD	chave parafusos dinamométrica	1-5	€ 89,00



Chave Dinamométrica 1/4"

Equipado com um medidor angular embutido

- Clique no mecanismo para sinalizar o torque necessário
- Escala de referência ft/lb adicional
- Marcado para mostrar o local correto onde a pressão deve ser aplicada
- Botão de travamento para garantir que o torque definido seja mantido
- Mecanismo de 24 dentes reversível (DIN3122) dando incrementos de 15°
- Projetado para apertar fixadores à direita (sentido horário)
- Precisão de +/- 4%, conformidade com ISO6789 para precisão
- Cada chave tem a sua própria certificação individual
- Fornecido em um prático estojo de armazenamento.

nºStock	Alcance Nm	Alcance ft/lb	Escala Nm	Escala ft/lb	L mm	W mm	H mm	Peso g	Preço
1492-AG-E	5-25	4-18	0.4	0.4	570	340	950	4350	€ 56,00



Chave Dinamométrica 3/8"

Equipado com um medidor angular embutido

• Clique no mecanismo para sinalizar o torque necessário • Escala de referência ft/lb adicional • Marcado para mostrar o local correto onde a pressão deve ser aplicada • Botão de travamento para garantir que o torque definido seja mantido • Mecanismo de **24 dentes** reversível (DIN3122) dando incrementos de 15° • Projetado para apertar fixadores à direita (sentido horário) • Precisão de +/- 4%, conformidade com ISO6789 para precisão • Cada chave tem a sua própria certificação individual • Fornecido em um prático estojo de armazenamento.

nºStock	Alcance Nm	Alcance ft/lb	Escala Nm	Escala ft/lb	L mm	W mm	H mm	Peso g	Preço
3892-AG-E1	5-25	4-18	0.4	0.4	277	27.6	20.6	580	€ 59,00
3892-AG-E3	20-110	15-75	1.0	1.0	368	35.9	27.7	580	€ 67,00



Chave Dinamométrica 3/8"

Mostrador analógico

• Clique no mecanismo para sinalizar o torque necessário • Escala de referência ft/lb adicional • Marcado para mostrar o local correto onde a pressão deve ser aplicada • Botão de travamento para garantir que o torque definido seja mantido • Mecanismo de **72 dentes** reversível (DIN3122) dando incrementos de 15° • Projetado para apertar fixadores à direita (sentido horário) • Precisão de +/- 4%, conformidade com ISO6789 para precisão • Cada chave tem a sua própria certificação individual • Fornecido em um prático estojo de armazenamento.

nºStock	Alcance Nm	Escala Nm	L mm	W mm	H mm	Peso g	Preço
3892-P060	12-60	0.5	380	36	36	930	€ 139,00
3892-P100	20-100	0.5	410	36	36	960	€ 141,00



Chave Dinamométrica 3/8"

Mostrador digital c/ 9 memórias

• Clique no mecanismo para sinalizar o torque necessário • Escala de referência ft/lb adicional • Marcado para mostrar o local correto onde a pressão deve ser aplicada • Botão de travamento para garantir que o torque definido seja mantido • Mecanismo de **45 dentes** reversível (DIN3122) dando incrementos de 15° • Projetado para apertar fixadores à direita e à esquerda (**Bi-direcional**) • Precisão de +/- 4%, conformidade com ISO6789 para precisão • Cada chave tem a sua própria certificação individual • Fornecido em um prático estojo de armazenamento. usa pilhas AA.

nºStock	Alcance Nm	Alcance ft/lb	Escala Nm	Escala ft/lb	L mm	W mm	H mm	Peso g	Preço
3892-D100	10-100	7-75	0.1	0.1	457	42.5	46.5	904	€ 400,00



Chave Dinamométrica 1/2"

Equipado com um medidor angular embutido

- Clique no mecanismo para sinalizar o torque necessário
- Escala de referência ft/lb adicional
- Marcado para mostrar o local correto onde a pressão deve ser aplicada
- Botão de travamento para garantir que o torque definido seja mantido
- Mecanismo de 24 dentes reversível (DIN3122) dando incrementos de 15°
- Projetado para apertar fixadores à direita (sentido horário)
- Precisão de +/- 4%, conformidade com ISO6789 para precisão
- Cada chave tem a sua própria certificação individual
- Fornecido em um prático estojo de armazenamento.

nºStock	Alcance Nm	Alcance ft/lb	Escala Nm	Escala ft/lb	L mm	W mm	H mm	Peso g	Preço
1292-AG-EP	40-210	30-150	1.0	1.0	465	46.9	33.4	1340	€ 74,00
1292-AG-E4	70-350	50-250	5.0	5.0	632	47.1	37.1	2400	€ 119,00



Chave Dinamométrica 1/2"

Equipado com um medidor angular embutido

- Clique no mecanismo para sinalizar o torque necessário
- Escala de referência ft/lb adicional
- Marcado para mostrar o local correto onde a pressão deve ser aplicada
- Botão de travamento para garantir que o torque definido seja mantido
- Mecanismo de 24 dentes reversível (DIN3122) dando incrementos de 15°
- Projetado para apertar fixadores à direita e à esquerda (Bi-direcional)
- Precisão de +/- 4%, conformidade com ISO6789 para precisão
- Cada chave tem a sua própria certificação individual
- Fornecido em um prático estojo de armazenamento.

nºStock	Alcance Nm	Alcance ft/lb	Escala Nm	Escala ft/lb	L mm	W mm	H mm	Peso g	Preço
1292-AG-ER	40-210	30-150	1.0	1.0	465	46.9	33.4	1340	€ 81,00
1292-AG-E4R	70-350	50-250	5.0	5.0	632	47.1	37.1	2400	€ 128,00



Chave Dinamométrica 1/2"

Mostrador analógico

- Clique no mecanismo para sinalizar o torque necessário
- Escala de referência ft/lb adicional
- Marcado para mostrar o local correto onde a pressão deve ser aplicada
- Botão de travamento para garantir que o torque definido seja mantido
- Mecanismo de 72 dentes reversível (DIN3122) dando incrementos de 15°
- Projetado para apertar fixadores à direita (sentido horário)
- Precisão de +/- 4%, conformidade com ISO6789 para precisão
- Cada chave tem a sua própria certificação individual
- Fornecido em um prático estojo de armazenamento.

nºStock	Alcance Nm	Escala Nm	L mm	W mm	H mm	Peso g	Preço
1292-P100	20-100	0.5	410	36	36	965	€ 142,00
1292-P200	40-200	1.0	490	42	44	1465	€ 152,00
1292-P320	60-320	2.0	560	42	44	1645	€ 283,00



Chave Dinamométrica 1/2"

Mostrador digital c/ 9 memórias

• Clique no mecanismo para sinalizar o torque necessário • Escala de referência ft/lb adicional • Marcado para mostrar o local correto onde a pressão deve ser aplicada • Botão de travamento para garantir que o torque definido seja mantido • Mecanismo de **45 dentes** reversível (DIN3122) dando incrementos de 15° • Projetado para apertar fixadores à direita e à esquerda (**Bi-direcional**) • Precisão de +/- 4%, conformidade com ISO6789 para precisão • Cada chave tem a sua própria certificação individual • Fornecido em um prático estojo de armazenamento. usa pilhas AA.

nºStock	Alcance Nm	Alcance ft/lb	Escala Nm	Escala ft/lb	L mm	W mm	H mm	Peso g	Preço
1292-D200	20-200	30-150	0.1	0.1	548	42.5	46.5	1200	€ 453,00



Chave Dinamométrica 1/2"

c/ Torque pé-definido

Equipado com um medidor angular embutido

• Clique no mecanismo para sinalizar o torque necessário • Escala de referência ft/lb adicional • Marcado para mostrar o local correto onde a pressão deve ser aplicada • Botão de travamento para garantir que o torque definido seja mantido • Mecanismo de **24 dentes** reversível (DIN3122) dando incrementos de 15° • Projetado para apertar fixadores à direita (sentido horário) • Precisão de +/- 4%, conformidade com ISO6789 para precisão • Cada chave tem a sua própria certificação individual • Fornecido em um prático estojo de armazenamento.

nºStock	Torque Pred. Nm	L mm	W mm	H mm	Peso g	Preço
1292-AG-090	90	513	46.9	33.4	1400	€ 65,00
1292-AG-110	110	513	46.9	33.4	1400	€ 65,00
1292-AG-120	120	513	46.9	33.4	1400	€ 65,00
1292-AG-140	140	513	46.9	33.4	1400	€ 65,00



Use com cuidado;

As chaves de torque são uma ferramenta de medição e precisam ser tratadas com cuidado.

Torque de renicialização;

Após o uso, ajuste o torque para a sua configuração mais baixa. Se não fizer isso com o tempo, as molas dentro da chave podem perder a tensão normal.

Armazenagem com segurança;

Todos os instrumentos de torque devem ser armazenados no seu estojo original.

Manutenção

As chaves de torque devem ser limpas e calibradas anualmente.

Reparação e manutenção;

Substitua as peças de desgaste periodicamente.



Barra de força

Nunca use a chave torque como barra de força.

Utilização

Não deixe cair a chave torque e nunca use um tubo para fazer uma extensão de força..

Uso consciente

Evite guardar a chave torque em locais com alta humidade ou em sítios de calor extremo.

Transporte

Garanta que todos os componentes e ferramenta estão devidamente acondicionados.



Chave Dinamométrica 3/4"

Equipado com um medidor angular embutido

- Clique no mecanismo para sinalizar o torque necessário
- Escala de referência ft/lb adicional
- Marcado para mostrar o local correto onde a pressão deve ser aplicada
- Botão de travamento para garantir que o torque definido seja mantido
- Mecanismo de 24 dentes reversível (DIN3122) dando incrementos de 15°
- Projetado para apertar fixadores à direita (sentido horário)
- Precisão de +/- 4%, conformidade com ISO6789 para precisão
- Cada chave tem a sua própria certificação individual
- Fornecido em um prático estojo de armazenamento.

nºStock	Alcance Nm	Alcance ft/lb	Escala Nm	Escala ft/lb	L mm	W mm	H mm	Peso g	Preço
3492-AG-E	65-450	48-330	5.0	5.0	850	72.5	53.5	3840	€ 181,00
3492-AG-E1	140-700	100-500	2.5	2.5	1065	72.5	53.5	6160	€ 490,00
3492-AG-E2	140-980	100-700	2.5	2.5	1213	72.5	53.5	6160	€ 573,00



Chave Dinamométrica 3/4"

Equipado com um medidor angular embutido

- Clique no mecanismo para sinalizar o torque necessário
- Escala de referência ft/lb adicional
- Marcado para mostrar o local correto onde a pressão deve ser aplicada
- Botão de travamento para garantir que o torque definido seja mantido
- Mecanismo de 24 dentes reversível (DIN3122) dando incrementos de 15°
- Projetado para apertar fixadores à direita e à esquerda (**Bi-direcional**)
- Precisão de +/- 4%, conformidade com ISO6789 para precisão
- Cada chave tem a sua própria certificação individual
- Fornecido em um prático estojo de armazenamento.

nºStock	Alcance Nm	Alcance ft/lb	Escala Nm	Escala ft/lb	L mm	W mm	H mm	Peso g	Preço
3492AG-ER	64-450	48-330	5.0	5.0	850	72.5	53.5	3840	€ 193,00



Chave Dinamométrica 3/4"

Mostrador analógico

- Clique no mecanismo para sinalizar o torque necessário
- Escala de referência ft/lb adicional
- Marcado para mostrar o local correto onde a pressão deve ser aplicada
- Botão de travamento para garantir que o torque definido seja mantido
- Mecanismo de 72 dentes reversível (DIN3122) dando incrementos de 15°
- Projetado para apertar fixadores à direita (sentido horário)
- Precisão de +/- 4%, conformidade com ISO6789 para precisão
- Cada chave tem a sua própria certificação individual
- Fornecido em um prático estojo de armazenamento.

nºStock	Alcance Nm	Escala Nm	L mm	W mm	H mm	Peso g	Preço
3492-P500	100-500	2.5	790	68	62	3100	€ 351,00



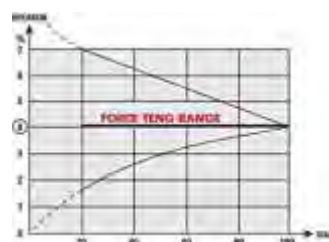

Conversão

1 Nm	= 0.1019Kgm	= 0.73756 Ft/Lb
1 Ft/Lb	= 0.1383 Kgm	= 1.13556 Nm
1 Ft/Lb	= 12 inch/lb	

Tolerância ISO6789 e BS6703

As normas indicam que a leitura mínima deverá ser de 20% e o desvio máximo deverá ser de +/-7%



Todas as chaves dinamométricas Teng Tools são testadas individualmente na fábrica para +/- 4% e contém um nº de inspeção individual tanto na chave como na folha de certificação/instruções. Todas as chaves deverão ser verificadas regularmente quanto à sua exactidão. A operação deverá ser feita por uma oficina autorizada. A desmontagem das chaves por agentes não autorizadas implica a anulação da garantia.

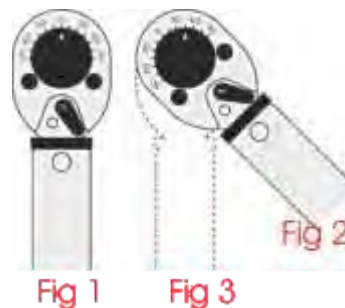

Utilizar o medidor de ângulos (virtual)

- 1 Pré definir a seta para 0 na escala de aumento (fig1).
- 2 Fixar a ch. ao parafuso (que se quer apertar) e alinhar a ch. virtualmente a outro ponto (fig1).
- 3 Rodar, sem apertar, a chave até ser atingido o ângulo necessário na escala circular (fig2).
- 4 Rodar em aperto a chave de volta à posição original até ficar outra vez alinhada (fig3)



TQ-AG | € 55,00

Medidor de ângulos magnético, para usar com chaves dinamométricas.



Chaves Dinamométricas «Inserção»

Clique no mecanismo para sinalizar o torque necessário

- Escala Nm simples de ajustar e fácil de ler
- Botão de travamento para garantir que o torque definido seja mantido
- Cabeça compacta para facilitar o uso em espaços confinados
- Mecanismo de 72 dentes de reversível (DIN3122)
- Projetado para apertar fixadores à direita (sentido horário)
- Pega ergonômica bimatéria para maior conforto
- Precisão de +/- 4%, conformidade com ISO6789 para precisão
- Cada torquímetro tem sua própria certificação individual
- Fornecido em um prático estojo de armazenamento.

ver chaves pág-214-215



nºStock	Descrição	Alcance Nm	Preço
1292-P912	para encaixe 9x12	20-100	€ 149,00
1292-P418	para encaixe 14x18	40-200	€ 156,00

nºStock	Descrição Cabeça Roquete	Quadra	Preço
3892-CQ-100R	para encaixe 9x12	3/8"	€ 24
1292-CQ-200R	para encaixe 14x18	1/2"	€ 27
3492-CQ-500R	para encaixe 14x18	3/4"	€ 93

ACD-01 | € 260,00

Kit 4 chaves dinamométricas para ar condicionado com torque predefinido.

Precisão +/- 4%. Conforme ISO 6789:1992.



nºStock	Medida mm	Torque Pre. Nm	Peso g	Preço
TQS-018	17	18	396	€ 70,00
TQS-042	22	42	428	€ 70,00
TQS-055	26	55	546	€ 72,00
TQS-065	29	65	576	€ 72,00



Multiplicadores de Torque (rácio 1:3)

Para uso com chaves dinamométricas e chaves de caixa impacto.

nºStock	Torque Max. Nm	Torque Max. lb/ft	Multiplicador	Ø Externo mm	Quadra entrada	Quadra saída	Peso g	Preço
MP-1400	1500	1100	x3	69	1/2"	3/4"	2280	€ 419,00
MP-2700	3000	2200	x3	92	3/4"	1"	4780	€ 483,00

Suporte p^a Multiplicadores de Torque

Para uso com multiplicadores de torque.

nºStock	Descrição	Preço
MP-SL01	Suporte para multiplicador de força MP1400	€ 44,00
MP-SL02	Suporte para multiplicador de força MP2700	€ 61,00



Multiplicadores de Torque (rácio 1:9)

Para uso com chaves dinamométricas e chaves de caixa impacto.

nºStock	Torque Max. Nm	Torque Max. lb/ft	Multiplicador	Quadra entrada	Quadra saída	Peso g	Preço
MP-9150	1500	1100	x9	1/2"	3/4"	3180	€ 463,00



nºStock	Quadra	Para:
1492AGERK	1/4"	1492AG-E
3892AG1RK	3/8"	3892AG-E1
3892AG3RK	3/8"	3892AG-E3
1292AGERK	1/2"	1292AG-E, 1292AG-EP
1292AGERRK	1/2"	1292AG-ER
1292AG4RK	1/2"	1292AG-E4
1292AG4RRK	1/2"	1292AG-E4R
3492AGERRK	3/4"	3492AG-ER
3492AGERK	3/4"	3492AG-E, 3492AG-E1 +3492AG-E2
3892P060RK-1	3/8"	3892P060
1292P100RK-1	1/2"	1292P100
1292P200RK-1	1/2"	1292P200
3492P500RK-1	3/4"	3492P500

Kits de Reparação - p^o Chaves dinamométricas - Preços sob consulta prévia



Medidor de Torque Electrónico

Para medir o torque de chaves dinamométricas, com precisão de +/- 1%.



nºStock	Alcance Nm	Prof. mm	Comp. mm	Altura mm	Peso g	Preço
TORQ-02	1.5-30	205	155	76	2940	€ 890,00
TORQ-03	7.5-150	205	155	76	3940	€ 900,00
TORQ-04	25-500	205	155	76	4060	€ 920,00
TORQ-05	50-1000	205	155	76	4060	€ 966,00

Medidor de Torque Electrónico

Para medir o torque de chaves dinamométricas, com precisão de +/- 1%.
Com conexão para impressora (TORP01).



nºStock	Alcance Nm	Prof. mm	Comp. mm	Altura mm	Peso g	Preço
TORQ-99E	10-400	200	160	85	2500	€ 966,00

Impressora pª Medidor de Torque

Para ligar ao medidor de torque TORQ99.



nºStock	Prof. mm	Comp. mm	Altura mm	Peso g	Preço
TORP-01E	220	180	95	1840	€ 800,00

TORQ-S01 | € 199,00

Banca metálica para medidor de torque TORQ99 e impressora TORP01E.
Dimensões 570 x 340 x 950mm, 1,64kg.

TORQ | € 1.850,00

Kit de Medição de Torque

Inclui banca metálica TORQS01, medidor de torque TORQ99 e impressora TORP01.



Plataforma pª Calibrar Chaves Dinamométricas

Plataforma para calibrar chaves dinamométricas, base equipada com adaptadores PCD (Pitch Circle Diameter) de 64,90mm e 150mm.



nºStock	Torque Max. Nm	Peso g	Preço
ICR-400	400	39000	€ 3.390,00
ICR-1500	1500	84000	€ 4.000,00





TENGTOOLS

TENGTOOLS

1892AG-F

1892AG-E

1892AG-E

MD9053-N | € 159,00

Jogo 53 peças, com 19 chaves de parafusos com cabo ergonómico bi-material, acessórios e bits. Fornecido em mala plástica.



Chaves parafusos	fend	3x75mm, 3x100mm, 4x100mm, 5.5x75mm, 5.5x150mm, 6x38mm, 6.5x100mm, 6.5x150mm, 8x150mm, 10x200mm
	PH	PH1x75mm, PH2x38mm, PH2x100mm, PH3x150mm
	PZ	PZ0x75mm, PZ1x75mm, PZ2x38mm, PZ2x100mm, PZ3x150mm
Acessórios		Chave de bits com roquete, inclui bits de fendas 1.2x5mm, 1.4x7mm, PH1, PH2, PZ1 e PZ2
Bits ¼" 25mm		PZ-0, - ROB 1,2,3 - HEX 2,3,4,5,6,8mm
	TX	TX6, TX7, TX8, TX9, TX10, TX15 (x2), TX20 (x2), TX25 (x2), TX27, TX30, TX40
	TPX	TPX20, TPX25, TPX30

MD910-N | € 67,00

Jogo 10 peças, chaves de parafusos com cabo ergonómico bi-material e chave 1000v.. Fornecido em mala plástica.

Chaves	fend	3.0x100mm, 5.5x75mm, 5.5x150mm, 6.5x150mm
	PH	PH0x75mm, PH1x75mm, PH2x100mm
	PZ	PZ1x75mm, PZ2x100mm
1000v	fend	3.0x100mm



MD911-N | € 69,00

Jogo 11 peças, chaves de parafusos com cabo ergonómico bi-material. Fornecido em mala plástica.

Chaves	fend	6.5x38mm, 3x100mm, 5.5x75mm, 5.5x150mm,
	PH	PH0x75mm, PH1x75mm, PH2 x38mm,
	PZ	PZ1x75mm, PZ2 x 100mm



MD912-N | € 71,00

Jogo 12 chaves de parafusos com cabo ergonómico bi-material. Fornecido em tabuleiro plástico.

Chaves parafusos	fend	2.5x75mm, 3.5x100mm, 4x150mm, 5.5x150mm, 6.5x150mm, 10x200mm
	PH	PH0x75mm, PH1x75mm, PH2x100mm,
	PZ	PZ1x75mm, PZ2x100mm



MD912-N1 | € 55,00

Jogo 12 peças, chaves de parafusos com cabo ergonómico bi-material e chaves isoladas 100v. Fornecido em tabuleiro plástico.

Chaves	fend	3.0x75mm, 3.5x100mm, 5.5x150mm
	PH/P	PH1x75mm, PH2x100mm, PZ2x100mm
	TX	TX20x100mm, TX25x100mm, TX30x100mm
1000v		fendas 2.5x75mm, 3.0x100mm, PH1x80mm



MD906-N5 | € 22,00

Jogo 5 peças, chaves de parafusos com cabo ergonómico bi-material.
Fornecido em tabuleiro plástico.

Chaves parafusos	fend	2,5 x 50mm, 3 x 75mm, 4x100mm, 5,5 x 150mm, 6,5 x 150mm
------------------	------	---

**MD906-N | € 37,00**

Jogo 6 peças, chaves de parafusos com cabo ergonómico bi-material.
Fornecido em tabuleiro plástico.

Chaves	fend	3 x 75mm, 5,5 x 150mm
	PH	PH1 x 75mm, PH2 x 100mm
	PZ	PZ1 x 75mm, PZ2 x 100mm

**MD906-N2 | € 27,50**

Jogo 6 peças, chaves de parafusos com cabo ergonómico bi-material.
Fornecido em tabuleiro plástico.

Chaves	PZ	PZ1 x 75mm, PZ2 x 100mm
	TX	TX10 x 100mm, TX15 x 100mm, TX20 x 100mm, TX25 x 100mm

**MD906-N3 | € 33,00**

Jogo 6 peças, chaves de parafusos com cabo ergonómico bi-material.
Fornecido em tabuleiro plástico.

Chaves	fend	3 x 75mm, 4 x 100mm, 5,5 x 75mm, 6,5 x 100mm
	PH	PH1 x 75mm, PH2 x 100mm

**MD906-N4 | € 30,00**

Jogo 6 peças, chaves de parafusos com cabo ergonómico bi-material.
Fornecido em tabuleiro plástico.

Chaves	fend	3 x 75mm, 4 x 100mm, 5,5 x 75mm, 6,5 x 100mm
	PZ	PZ1 x 75mm, PZ2 x 100mm

**MD906N1 | € 43,00**

Jogo 6 peças, chaves de parafusos TX com cabo ergonómico bi-material.
Fornecido em tabuleiro plástico.

Chaves parafusos	TX	TX10x100mm, TX15x100mm, TX20x100mm, TX25x100mm, TX30x100mm, TX40x100mm
------------------	----	--



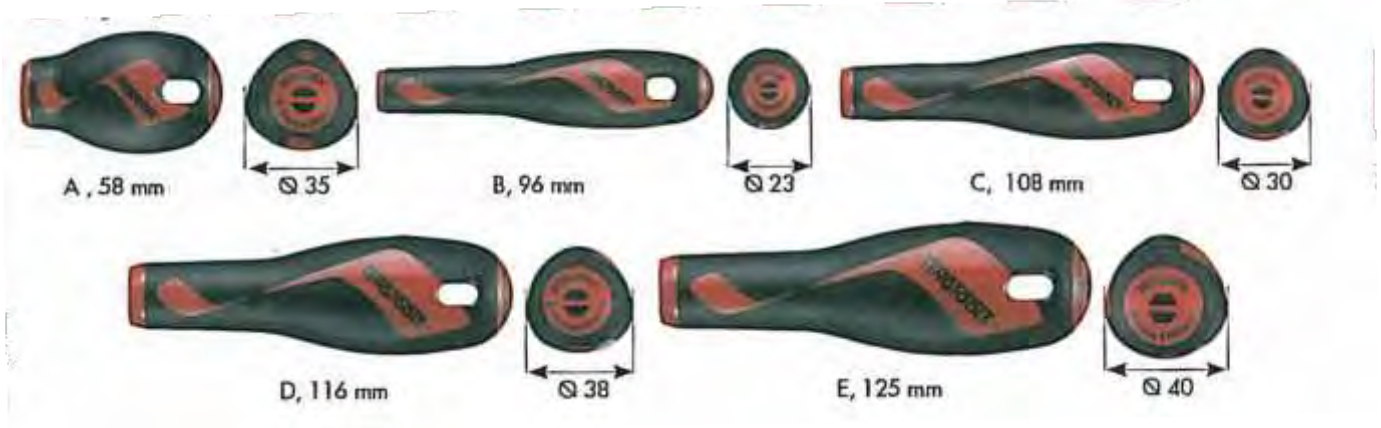

Chaves de Parafusos - Fendas

Chaves de parafusos de fendas, em aço TT-MV PLUS, ponteira preta e cabo ergonómico bi-material. Conforme DIN 5264.

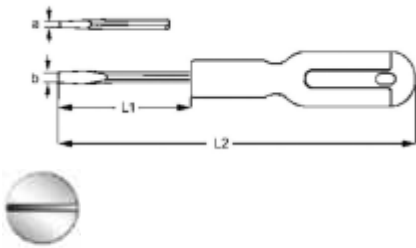

nºStock	a mm	b mm	Lâmina	L1 mm	L2 mm	Peso g	Cabo	Preço
MD-914-N	0.4	2.5	redonda	50	146	24	S	€ 3,90
MD-915-N	0.5	2.5	redonda	75	171	24	S	€ 3,90
MD-915-N1	0.5	2.5	redonda	200	296	25	S	€ 4,90
MD-920-N	0.5	3.0	redonda	75	171	27	S	€ 4,50
MD-920-N1	0.5	3.0	redonda	100	196	31	S	€ 4,70
MD-916-N	0.6	3.5	redonda	75	171	29	S	€ 4,50
MD-916-N1	0.6	3.5	redonda	100	196	31	S	€ 4,70
MD-916-N2	0.6	3.5	redonda	150	246	38	S	€ 5,20
MD-917-N	0.8	4.0	redonda	100	196	31	S	€ 4,70
MD-917-N1	0.8	4.0	redonda	400	496	41	S	€ 7,10
MD-917-N2	0.8	4.0	redonda	150	246	38	S	€ 5,30
MD-922-N	1.0	5.5	redonda	75	246	38	S	€ 6,00
MD-923-N	1.0	5.5	redonda	150	258	64	M	€ 6,40
MD-923-N1	1.0	5.5	redonda	200	308	74	M	€ 6,90
MD-928-N	1.2	6.5	redonda	38	96	45	XS	€ 5,40
MD-928-N1	1.2	6.5	redonda	100	216	93	L	€ 7,40
MD-928-N2	1.2	6.5	redonda	150	266	105	L	€ 7,70
MD-928-N3	1.2	6.5	redonda	200	316	115	L	€ 8,20
MD-928-N4	1.2	6.5	redonda	100	208	105	M	€ 7,10
MD-928-N5	1.2	6.5	redonda	150	258	110	M	€ 7,60
MD-928-N6	1.2	6.5	redonda	200	308	113	M	€ 8,20
MD-928-N7	1.2	6.5	redonda	400	508	185	M	€ 11,70
MD-930-N	1.6	10.0	redonda	200	325	231	XL	€ 12,30
MD-931-N	1.0	5.5	hex	125	253	96	L	€ 7,10
MD-932-N	1.2	6.5	hex	100	216	101	L	€ 7,50
MD-932-N1	1.2	6.5	hex	150	266	114	L	€ 8,10
MD-932-N2	1.2	6.5	hexn	400	516	181	L	€ 14,00
MD-934-N	1.2	8.0	hex	150	275	156	XL	€ 10,50
MD-935-N	1.6	10.0	hexn	200	325	226	XL	€ 12,70



Chaves de Parafusos - PH

Chaves de parafusos PH, em aço TT-MV PLUS, ponteira preta e cabo ergonómico bi-material. Conforme DIN 5260.

nºStock	Medida	Lâmina	L1 mm	L2 mm	Peso g	Cabo	Preço
MD-940-N	PH0	redonda	75	171	27	S	€ 5,50
MD-940-N1	PH0	redonda	300	369	41	S	€ 6,20
MD-947-N	PH1	redonda	38	96	40	XS	€ 5,40
MD-947-N1	PH1	redonda	75	183	29	M	€ 5,80
MD-947-N2	PH1	redonda	150	258	61	M	€ 7,70
MD-948-N	PH2	redonda	38	96	46	XS	€ 5,40
MD-948-N1	PH2	redonda	100	216	93	L	€ 7,30
MD-948-N2	PH2	redonda	200	316	115	L	€ 8,40
MD-948-N3	PH2	redonda	400	516	153	L	€ 11,90
MD-948-N4	PH2	redonda	100	208	90	M	€ 7,10
MD-948-N5	PH2	redonda	200	308	110	M	€ 8,00
MD-948-N8	PH2	redonda	300	408	114	M	€ 10,00
MD-948-N6	PH2	redonda	400	508	148	M	€ 11,50
MD-949-N	PH3	redonda	150	275	152	XL	€ 9,90
MD-950-N	PH4	redonda	200	325	261	XL	€ 12,40
MD-952-N	PH2	hex	100	216	101	L	€ 7,70
MD-952-N1	PH2	hex	400	516	181	L	€ 19,00
MD-953-N	PH3	hex	150	275	159	XL	€ 10,50
MD-954-N	PH4	hex	200	325	231	XL	€ 12,70

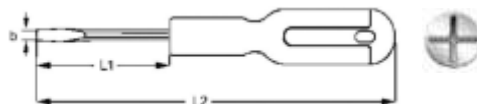

Chaves de Parafusos - PZ

Chaves de parafusos PZ, em aço TT-MV PLUS, ponteira preta e cabo ergonómico bi-material. Conforme DIN 5260.

nºStock	Medida	Lâmina	L1 mm	L2 mm	Peso g	Cabo	Preço
MD-960-N	PZ0	redonda	75	171	27	S	€ 4,40
MD-961-N	PZ1	redonda	75	183	29	M	€ 5,80
MD-961-N1	PZ1	redonda	250	358	73	M	€ 7,40
MD-961-N2	PZ1	redonda	38	96	40	XS	€ 5,60
MD-962-N	PZ2	redonda	100	216	93	L	€ 7,30
MD-962-N1	PZ2	redonda	150	266	105	L	€ 7,70
MD-962-N2	PZ2	hex	100	216	101	L	€ 7,50
MD-962-N3	PZ2	redonda	38	96	45	XS	€ 5,40
MD-962-N4	PZ2	redonda	100	208	98	M	€ 7,20
MD-962-N5	PZ2	redonda	150	258	100	M	€ 7,40
MD-962-N4A	PZ2	redonda	200	308	93	M	€ 8,20
MD-962-N4C	PZ2	redonda	300	408	93	M	€ 9,70
MD-962-N4D	PZ2	redonda	400	508	93	M	€ 11,50
MD-963-N	PZ3	hex	150	275	158	XL	€ 10,50
MD-964-N	PZ4	hex	200	325	231	XL	€ 12,70

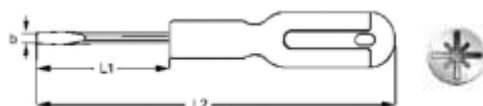

MDM-C702-N | € 7,80

Jogo 2 peças **Mini**

chaves de parafusos com cabo ergonómico bi-material e clip de bolso.

Chaves	fendas	3.0 x 50mm
	PH	PH1 x 50mm



MDM-C715-N | € 3,80

Chaves de parafusos **Mini**

PH com cabo ergonómico bi-material e clip de bolso.

Chaves	PH	PH1 x 50mm
--------	----	------------



MDM-C718-N | € 3,80

Chaves de fendas **Mini**

com cabo ergonómico bi-material e clip de bolso.

Chaves	fendas	3.0 x 50mm
--------	--------	------------



Chaves de Pancada - Fendas

Chaves de pancada de fendas, em aço-vanádio cromado, cabo TPR bi-material com batente. Conforme DIN 5264.

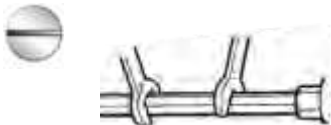

nºStock	a mm	b mm	Lâmina	L1 mm	L2 mm	Peso g	Cabo	Preço
MDT-932-N	1.2	6.5	hex	100	216	120	L	€ 8,30
MDT-934-N	1.2	8	hex	150	275	200	XL	€ 11,50
MDT-935-N	1.6	10	hex	200	325	200	XL	€ 13,50



Chaves de Pancada - PH

Chaves de pancada PH, em aço-vanádio cromado, cabo TPR bi-material com batente. Conforme DIN 5264.



nºStock	Medida	Lâmina	L1 mm	L2 mm	Peso g	Cabo	Preço
MDT-952-N	PH2	hex	100	216	120	L	€ 8,30
MDT-953-N	PH3	hex	150	275	200	XL	€ 11,50



Chaves de Parafusos - TX

Chaves de parafusos TX, em aço-vanádio cromado, ponteira preta e cabo ergonómico bi-material.

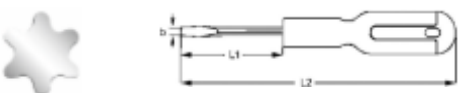

nºStock	Medida	Lâmina	L1 mm	L2 mm	Peso g	Cabo	Preço
MD-906-TN	TX6	redonda	75	171	29	S	€ 4,80
MD-907-TN	TX7	redonda	75	171	29	S	€ 4,80
MD-908-TN	TX8	redonda	75	171	29	S	€ 4,80
MD-909-TN	TX9	redonda	75	171	29	S	€ 4,80
MD-910-TN	TX10	redonda	100	208	58	M	€ 6,20
MD-915-TN	TX15	redonda	100	208	58	M	€ 6,20
MD-920-TN	TX20	redonda	100	208	58	M	€ 6,30
MD-925-TN	TX25	redonda	100	216	93	L	€ 7,60
MD-927-TN	TX27	redonda	100	216	94	L	€ 7,60
MD-930-TN	TX30	redonda	100	216	94	L	€ 7,60
MD-940-TN	TX40	redonda	100	216	106	L	€ 7,60
MD-945-TN	TX45	redonda	125	205	237	XL	€ 10,60



Chaves de Parafusos - TPX

Chaves de parafusos TPX, em aço-vanádio cromado, ponteira preta e cabo ergonómico bi-material.

nºStock	Medida	Lâmina	L1 mm	L2 mm	Peso g	Cabo	Preço
MD-610-TPN	TPX10	redonda	100	208	58	M	€ 6,50
MD-615-TPN	TPX15	redonda	100	208	58	M	€ 6,50
MD-620-TPN	TPX20	redonda	100	208	58	M	€ 6,50
MD-625-TPN	TPX25	redonda	100	216	94	L	€ 7,90
MD-627-TPN	TPX27	redonda	100	216	94	L	€ 7,90
MD-630-TPN	TPX30	redonda	100	216	94	L	€ 7,90
MD-640-TPN	TPX40	redonda	100	216	105	L	€ 7,90



Chaves de Parafusos - Umbrako

Chaves de parafusos Umbrako. Punho ergonómico bi-material.

nºStock	Medida	Lâmina	L1 mm	L2 mm	Peso g	Cabo	Preço
MD-7020-HN	2	redonda	100	196	25	S	€ 4,20
MD-7025-HN	2.5	redonda	100	196	31	S	€ 4,30
MD-7030-HN	3	redonda	100	196	31	S	€ 4,40



Chaves de Parafusos - Umbrako Boleada

Chaves de parafusos Umbrako com ponta esférica. Punho ergonómico bi-material.

nºStock	Medida	Lâmina	L1 mm	L2 mm	Peso g	Cabo	Preço
MD-7020-HBN	2	redonda	100	196	26	S	€ 4,40
MD-7025-HBN	2.5	redonda	100	196	28	S	€ 4,40
MD-7030-HBN	3	redonda	150	246	38	S	€ 4,80
MD-7040-HBN	4	redonda	150	258	66	M	€ 5,30
MD-7050-HBN	5	redonda	150	266	105	L	€ 6,40
MD-7060-HBN	6	redonda	150	266	120	L	€ 8,30
MD-7080-HBN	8	redonda	150	275	200	XL	€ 11,30

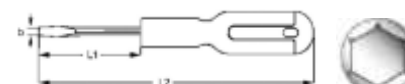

Chaves de Parafusos - ROB

Chaves de parafusos ROB, em aço-vanádio cromado, ponteira preta e cabo ergonómico bi-material.

nºStock	Medida	Lâmina	L1 mm	L2 mm	Peso g	Cabo	Preço
MD-801-N	1	redonda	100	216	94	L	€ 7,20
MD-802-N	2	redonda	100	216	94	L	€ 7,20
MD-803-N	3	redonda	100	216	94	L	€ 7,20



Lâminas Combinadas

Lâminas hexagonais com ponteira em ambas as extremidades, para usar com cabo MD901, ou como peças de substituição para tabuleiro TTMD12D.



nºStock	Descrição	Ponta	Preço
MD-901	Cabo ergonómico	-	
PZZ-0102	Lâmina combinada	PZ1 - PZ2	€ 8,20
PHH-0102	Lâmina combinada	PH1 - PH2	€ 6,60
FTF-4055	Lâmina combinada	fendas 4.0mm - fendas 5.5mm	€ 6,60
PH-F0365	Lâmina combinada	PH3 - fendas 6.5mm	€ 6,60
TXX-1015	Lâmina combinada	TX10 - TX15	€ 6,60
TXX-2025	Lâmina combinada	TX20 - TX25	€ 6,60
TXX-3040	Lâmina combinada	TX30 - TX40	€ 6,60
HBH-0303	Lâmina combinada	boleada hex 3.0mm - hex 3.0mm	€ 7,60
HBH-0404	Lâmina combinada	boleada hex 4.0mm - hex 4.0mm	€ 7,60
HBH-0505	Lâmina combinada	boleada hex 5.0mm - hex 5.0mm	€ 7,60
HBH-0606	Lâmina combinada	boleada hex 6.0mm - hex 6.0mm	€ 7,60



TM-708 | € 26,00

Conjunto de lâminas combinadas de precisão, lâminas hexagonais com ponteira em ambas as extremidades.



Acessórios	cabo para lâminas combinadas
Lâminas 120mm	fenda 2.0mm x PH00, fenda 3.0mm x PH0, fenda 4.0mm x PH1, PZ0 x PZ1, TX5 x TX7, TX6 x TX8, TX9 x TX10

Lâminas Combinadas

Lâminas hexagonais com ponteira em ambas as extremidades, para usar com cabo MDM700, ou como peças de substituição para tabuleiro TM708.



nºStock	Descrição	Ponta	Preço
MDM-700	Cabo ergonómico	-	€ 4,40
2912512	Lâmina combinada	fenda 2.0mm - PH00	€ 3,50
2912513	Lâmina combinada	fenda 3.0mm - PH0	€ 3,50
2912514	Lâmina combinada	fenda 4.0mm - PH1	€ 3,50
2912520	Lâmina combinada	PZ0 - PZ1	€ 3,50
2912535	Lâmina combinada	TX5 - TX7	€ 3,50
2912537	Lâmina combinada	TX6 - TX8	€ 3,50
2912539	Lâmina combinada	TX9 - TX10	€ 3,50



MDM-706 | € 20,00

Jogo 6 chaves de precisão, aço CrMo. Inclui suporte para afixar a banca de trabalho ou a parede.

Chaves	fendas	2.0x40mm, 2.4x40mm, 3.0x40mm
	PH	PH00x40mm, PH0x40mm, PH1x40mm

**Chaves de Precisão - Hexagonais**

Chaves de precisão hexagonais, em aço CrMo, ponteira preta.

nºStock	Medida mm	Lâmina	L1 mm	L2 mm	Peso g	Preço
MDM-711	2.0	redonda	40	122	12	€ 4,40
MDM-712	2.5	redonda	40	122	12	€ 4,40

**Chaves de Precisão - Fendas**

Chaves de precisão fendas, em aço CrMo, ponteira preta.

nºStock	Medida mm	Lâmina	L1 mm	L2 mm	Peso g	Preço
MDM-713	2.0	redonda	40	122	12	€ 4,40
MDM-714	2.4	redonda	40	122	12	€ 4,40
MDM-715	3.0	redonda	40	122	12	€ 4,40

**Chaves de Precisão - PH**

Chaves de precisão PH, em aço CrMo, ponteira preta.

nºStock	Medida mm	Lâmina	L1 mm	L2 mm	Peso g	Preço
MDM-716	PH00	redonda	40	122	12	€ 4,40
MDM-717	PH0	redonda	40	122	12	€ 4,40
MDM-718	PH1	redonda	40	122	12	€ 4,40



MDM-706-TXT | € 20,00

Jogo 6 chaves T de precisão TX, aço CrMo. Inclui suporte para afixar a banca de trabalho ou a parede.



Chaves T	TX6, TX7, TX8, TX9, TX10 e TX15
----------	---------------------------------

Chaves T de Precisão - TX

Chaves T de precisão TX.



nºStock	Medida	Peso g	Preço
MDM-806T	TX6	10	€ 4,20
MDM-807T	TX7	10	€ 4,20
MDM-808T	TX8	10	€ 4,20
MDM809T	TX9	15	€ 4,20
MDM-810T	TX10	15	€ 4,20
MDM-815T	TX15	15	€ 4,20

MDM-706-TX | € 20,00

Jogo 6 chaves de precisão TX, aço CrMo. Inclui suporte para afixar a banca de trabalho ou a parede.



Chaves	TX	TX6, TX7, TX8, TX9, TX10, TX15
--------	----	--------------------------------

Chaves de Precisão - TX

Chaves de precisão TX, em aço CrMo, ponteira preta.



nºStock	Medida mm	Lâmina	L1 mm	L2 mm	Peso g	Preço
MDM-806	TX6	redonda	40	122	12	€ 4,40
MDM-807	TX7	redonda	40	122	12	€ 4,40
MDM-808	TX8	redonda	40	122	12	€ 4,40
MDM-809	TX9	redonda	40	122	12	€ 4,40
MDM-810	TX10	redonda	40	122	12	€ 4,40
MDM-815	TX15	redonda	40	122	12	€ 4,40



MR-500 | € 7,80

Magnetizador/Desmagnetizador para chaves de parafusos, fornecido com anel porta chaves.



Bits - Umbrako

Bits Umbrako 40mm e 75mm, quadra hexagonal 10 e 12 mm. DIN 3126.



nºStock	Medida mm	Quadra mm	Pack qtd.	Comp. mm	Preço
210705	5	10 hex	1	40	€ 2,40
210706	6	10 hex	1	40	€ 2,40
210707	7	10 hex	1	40	€ 2,40
210708	8	10 hex	1	40	€ 2,40
210709	9	10 hex	1	40	€ 2,40
210710	10	10 hex	1	40	€ 2,40
210712	12	12 hex	1	40	€ 2,90
210714	14	12 hex	1	40	€ 5,40
210717	17	12 hex	1	40	€ 6,80
210719	19	12 hex	1	40	€ 8,10

nºStock	Medida mm	Quadra mm	Pack qtd.	Comp. mm	Preço
210805	5	10 hex	1	75	€ 3,50
210806	6	10 hex	1	75	€ 3,50
210807	7	10 hex	1	75	€ 3,50
210808	8	10 hex	1	75	€ 3,50
210809	9	10 hex	1	75	€ 3,50
210810	10	10 hex	1	75	€ 3,50
210812	12	12 hex	1	75	€ 4,90
210814	14	12 hex	1	75	€ 7,60
210817	17	12 hex	1	75	€ 10,90
210819	19	12 hex	1	75	€ 12,70



Bits - TX

Bits TX 40mm e 75mm, com quadra hexagonal de 10 e 12mm. DIN 3126.



nºStock	Medida	Quadra mm	Pack qtd.	Comp. mm	Preço
220720	TX20	10 hex	1	40	€ 2,40
220725	TX25	10 hex	1	40	€ 2,40
220727	TX27	10 hex	1	40	€ 2,40
220730	TX30	10 hex	1	40	€ 2,40
220740	TX40	10 hex	1	40	€ 2,40
220745	TX45	10 hex	1	40	€ 2,40
220750	TX50	10 hex	1	40	€ 2,40
220755	TX55	10 hex	1	40	€ 2,40
220760	TX60	12 hex	1	40	€ 2,70
220770	TX70	12 hex	1	40	€ 5,40

nºStock	Medida	Quadra mm	Pack qtd.	Comp. mm	Preço
220820	TX20	10 hex	1	75	€ 3,50
220825	TX25	10 hex	1	75	€ 3,50
220827	TX27	10 hex	1	75	€ 3,50
220830	TX30	10 hex	1	75	€ 3,50
220840	TX40	10 hex	1	75	€ 3,50
220845	TX45	10 hex	1	75	€ 3,50
220850	TX50	10 hex	1	75	€ 3,50
220855	TX55	10 hex	1	75	€ 3,50
220860	TX60	12 hex	1	75	€ 4,90
220870	TX70	12 hex	1	75	€ 7,30

TM-029 | € 43,00

Jogo de 29 peças, bits e acessórios.



Acess	1/4" hex	encabadoiro magnético 50mm , adaptador 1/4"hex:1/4"M, chave roquete par bits 1/4" / luneta
Bits 25mm	1/4" hex	fenda 0.6x4.5, 0.8x5.5, 1.2x6.5mm, PH 1, PH2, PH3, PZ1, PZ2, PZ3, TX10, TX15, TX20, TX25, TX30, TX40, TPX20, TPX25, TPX30, ROB No. 1, No. 2, No. 3, Hex 4, 5, 6, GR no.2 (2 pc)

TJ-1429 | € 42,00

Jogo de 29 peças, bits e acessórios.



Acess	1/4" hex	encabadoiro magnético 50mm , adaptador 1/4"hex:1/4"M, chave roquete par bits 1/4" / luneta
Bits 25mm	1/4" hex	PH3, Hex 3mm, TX30, TX20, TX40, Magnetic Bit Holder 50mm, Flat 0.6 x 3.5mm, Hex 5mm, PH1, Flat 1.6 x 8.0mm, PH2, Hex 2mm, Mini Ratchet, TX25, Hex 6mm, TPX30, ROB2, TX10, ROB3, TPX20, PZ2, PZ1, Hex 4mm, Hex 8mm, ROB1, PZ3, Flat 1.0 x 5.5mm, TPX25, TX15.

TJ-028 | € 23,00

Jogo de 28 peças, bits e acessórios.



Acess	1/4" hex	encabadoiro 50mm com sistema de libertação rápida , adaptador 1/4"hex:1/4"M
Bits 25mm	1/4" hex	Hex Bits 5mm, TX Bits TX40, TX Bits TX20, TX Bits TX30, PH Bits PH3, TPX Bits TPX30, Hex Bits 6mm , TX Bits TX25, Hex Bits 4mm, ROB Bits ROB2, TX Bits TX10, ROB Bits ROB1, PZ Bits PZ3, ROB Bits ROB3, TPX Bits TPX20, PZ Bits PZ2, TPX Bits TPX25, PZ Bits PZ1, TX Bits TX15, Flat Bits 1.2 x 6.5mm, Quick Chuck Bit Holder 50mm, Flat Bits 0.8 x 5.5mm, Flat Bits 0.6 x 4.5mm, Hex Socket Adaptor 1/4" Hex - 1/4" , PH Bits PH1, PH Bits PH2, PH2G.

TH-BS22 | € 18,90

Jogo de bits, 22 peças.

Acess	1/4" hex	encabadoiro magnético 60mm, adp 1/4"hex:1/4"M
Bits 25mm	1/4" hex	fenda 4.5, 5.5, 6.5mm, PH1, PH2, PH3, PZ1, PZ2, PZ3, GR2, 3, 4, 5, 6mm hex, TX10, 15, 20, 25, 30, 40

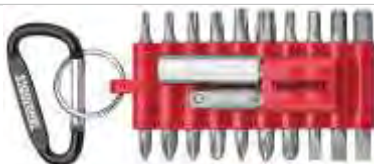

M-1410-T5 | € 21,50

Jogo de bits TX 5 pontos IPR, 10 peças.

Acess	adaptador F 1/4" - Hex1/4"	
Bits 1/4" TX	TX10, 15, 20, 25, 27, 30, 40, 45, 50	



1486 | € 10,50

Jogo de bits TX, 7 peças.

Acess	adaptador F 3/8" - Hex 1/4"	
Bits 1/4" TX	TX10, 15, 20, 25, 30, 40	



1488 | € 10,00

Jogo de bits TX, 4 peças.

Acess	adaptador F 1/2" - Hex 5/16"	
Bits 5/16" TX	TX45, 50, 55	



MD-BH | € 7,30

Chave de bits magnética 1/4" hexagonal com cabo ergonómico bi-material.

**MD-908-N | € 13,00**

Jogo de 9 peças, bits e acessórios.

Acessórios	1/4" hex	chave de bits magnética
------------	----------	-------------------------

Bits 25mm	1/4" hex	fenda 6.5, 8.0mm, PH1, PH2, PZ1, PZ2, Hex 4, 5mm
-----------	----------	--

**MDR-908-S | € 14,20**

Chave de bits com roquete reversível, cabo ergonómico bi-material com compartimento para armazenar bits.

Bits	1/4" hex	fendas 5, 7mm, PH1, PH2, PZ1, PZ2 e adaptador 1/4"hex:1/4"M
------	----------	---

**MDR-908 | € 15,40**

Chave de bits com roquete reversível, cabo ergonómico bi-material com compartimento para armazenar bits.

Bits	1/4" hex	fendas 5, 7mm, PH1, PH2, PZ1, PZ2 e adaptador 1/4"hex:1/4"M
------	----------	---

**MDR-915 | € 19,50**

Chave de bits com roquete reversível, cabo ergonómico bi-material com compartimento para armazenar bits.

Bits Duplos	1/4" hex	fendas 4 x 6mm, PH0 x PH3, PH1 x PH2, PZ0 x PZ3, PZ1 x PZ2, TX10 x TX15, TX20 x TX25
-------------	----------	--

**MDRT-908 | € 41,30**

Chave de bits articulada com roquete reversível, cabo ergonómico bi-material com compartimento para armazenar bits.

Bits	1/4" hex	fendas 5, 7mm, PH1, PH2, PZ1, PZ2 e adaptador 1/4"hex:1/4"M
------	----------	---



MD-THQ | € 15,50

Chave tipo T para bits 1/4" hexagonais, com sistema de libertação rápida no braço longo (130mm) e magnética no braço curto (75mm).



MDQ-147 | € 11,30

Chave para bits 1/4", com cabo ergonómico bi-material e sistema de libertação rápida. Comprimento total 147mm.



MDQ-183 | € 12,50

Chave para bits 1/4", com cabo ergonómico bi-material e sistema de libertação rápida. Comprimento total 183mm.



MDQ-217 | € 12,80

Chave para bits 1/4", com cabo ergonómico bi-material e sistema de libertação rápida. Comprimento total 217mm.



MDR-Q-908 | € 21,80

Chave de bits com roquete reversível, sistema de libertação rápida, cabo ergonómico bi-material com compartimento para armazenar bits.

Bits	1/4" hex	fendas 5, 7mm, PH1, PH2, PZ1, PZ2 e adaptador 1/4"hex:1/4"M
------	----------	---

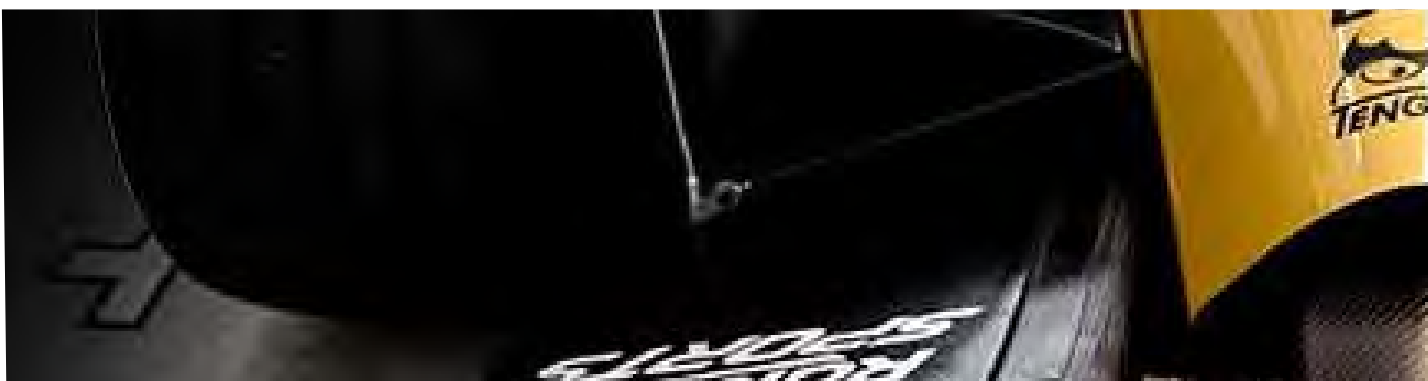

MD-907-FL | € 15,10

Chave para bits 1/4" fléxivel de 555mm, magnética, com cabo Mega Drive bi-material.

**MD-193 | € 8,80**

Chave para bits 1/4", com cabo ergonómico bi-mateirial. Comprimento total 193mm.

**MD-216 | € 8,70**

Chave para bits 1/4", com cabo ergonómico bi-mateirial. Comprimento total 216mm.

**Extensões**

Extensões para bits 1/4" hexagonais.

nºStock	Quadra	Descrição	Comp. mm	Preço
TT-MD74-1	1/4"	extensão fixa	100 (4")	€ 1,20
TT-MD74-2	1/4"	extensão flexível	150 (6")	€ 2,60

**ACC-300-CBH01 | € 18,80**

Extensão flexível 1/4" hexagonal de 300m, Torque máximo 3Nm..

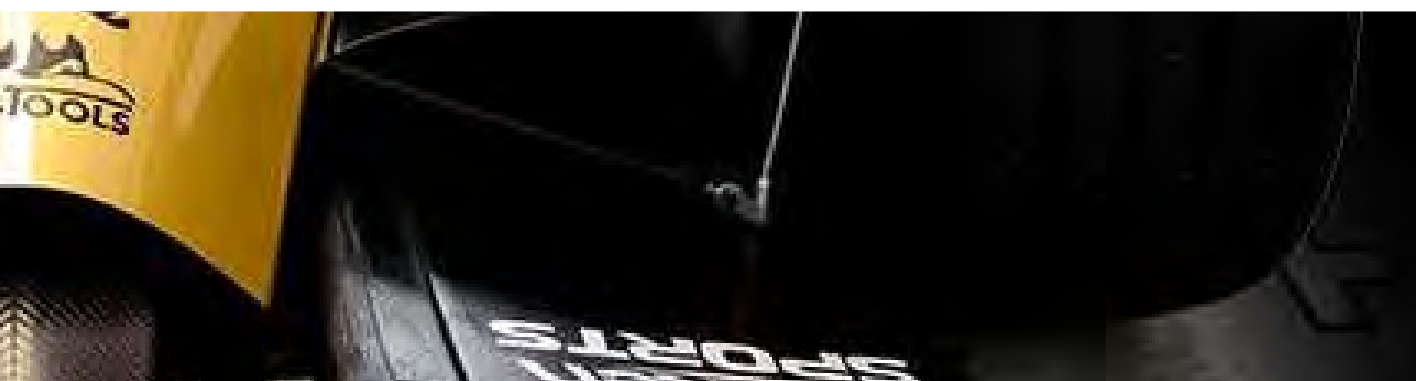

Encabadouros

Encabadouros para bits 1/4" hexagonais.



nºStock	Descrição	Quadra	Comp. mm	Preço
ACC-50-MBH-01	Magnético	1/4" hex	50	€ 4,10
ACC-70-MBH-01	Magnético	1/4" hex	70	€ 5,40
ACC-35-CBH-01	Encaixe rápido	1/4" hex	35	€ 12,40
ACC-50-CBH-01	Encaixe rápido	1/4" hex	70	€ 10,50

Adaptadores p^a Bits

Para utilizar com chaves de caixa e chaves de caixa impacto (não utilizar com máquinas de impacto).



nºStock	Descrição	Quadra	Quadra	Preço
ACC-SDA-1414	Adaptador 50mm	1/4" hex	1/4"M	€ 3,50
ACC-SDA-1438	Adaptador 50mm	1/4" hex	3/8"M	€ 5,70
ACC-SDA-1412	Adaptador 50mm	1/4" hex	1/2"M	€ 6,60



Bits - Caixa

Bits caixa, 1/4" hexagonais.

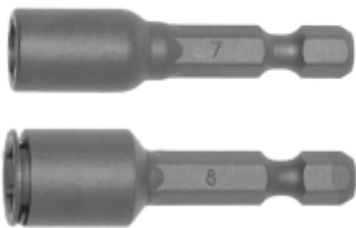

nºStock	Medida	Quadra	Tipo	Comp. mm	Preço
NS-45108-M	1/4"	1/4" hex	Magnético	45	€ 3,50
NS-45506-M	6mm	1/4" hex	Magnético	45	€ 3,50
NS-45507-M	7mm	1/4" hex	Magnético	45	€ 3,80
NS-45508-M	8mm	1/4" hex	Magnético	45	€ 3,80
NS-45508-R	8mm	1/4" hex	Anel	45	€ 3,80



Bits Duplos - Fendas

Bits duplos 1/4" hexagonais de 32mm.



nºStock	Medida (1)	Medida (2)	Quadra	Pack qt.	Comp. mm	Preço
FTF-32406005	fenda 0.8 x 4mm	fenda 1.5 x 6mm	1/4"Hex	5	32	€ 5,30



Bits - Fendas

Bits 1/4" hexagonais de 25mm. DIN 3126.



nºStock	Medida mm	Quadra	Pack qtd.	Comp. mm	Preço
FL-2506A03	0.6x3.5	1/4" hex	3	25	€ 2,90
FL-2506B03	0.6x4.5	1/4" hex	3	25	€ 2,90
FL-2508A03	0.8x4.0	1/4" hex	3	25	€ 2,90
FL-2508B03	0.8x5.5	1/4" hex	3	25	€ 2,90
FL-2510A03	1.0x5.5	1/4" hex	3	25	€ 2,90
FL-2512A03	1.2x6.5	1/4" hex	3	25	€ 2,90
FL-2516A03	1.6x8.0	1/4" hex	3	25	€ 3,90



Bits - Fendas

Bits 1/4" hexagonais de 50mm. DIN 3126.



nºStock	Medida mm	Quadra	Pack qtd.	Comp. mm	Preço
F-L5006A03	0.6x3.5	1/4" hex	3	50	€ 3,95
FL-5008A03	0.8x4.0	1/4" hex	3	50	€ 3,95
FL-5008B03	0.8x5.5	1/4" hex	3	50	€ 3,95
FL-5010A03	1.0x5.5	1/4" hex	3	50	€ 3,95
FL-5012A03	1.2x6.5	1/4" hex	3	50	€ 3,95



Bits - Fendas

Bits 1/4" hexagonais de 70mm. DIN 3126.



nºStock	Medida mm	Quadra	Pack qtd.	Comp. mm	Preço
FL-7006A02	0.6x3.5	1/4" hex	2	70	€ 3,95
FL-7008A02	0.8x4.0	1/4" hex	2	70	€ 3,95
FL-7008B02	0.8x5.5	1/4" hex	2	70	€ 3,95
F-L7010A02	1.0x5.5	1/4" hex	2	70	€ 3,95



Bits - Fendas

Bits 1/4" hexagonais de 89mm. DIN3126.



nºStock	Medida mm	Quadra	Pack qtd.	Comp. mm	Preço
FL-8905A01	0.5x3.0	1/4" hex	1	89	€ 5,50
FL-8908A01	0.8x4.0	1/4" hex	1	89	€ 5,50



Bits Duplos - PH

Bits duplos PH 1/4" hexagonais de 32mm.



n°Stock	Medida (1)	Medida (2)	Quadra	Pack qt.	Comp. mm	Preço
PHH-32000305	PH0	PH3	1/4"Hex	5	32	€ 5,10
PHH-32010205	PH1	PH2	1/4"Hex	5	32	€ 5,10

Bits - PH

Bits PH 1/4" hexagonais de 25mm. DIN 3126.



n°Stock	Medida	Quadra	Pack qtd.	Comp. mm	Preço
PH-2500103	PH1	1/4" hex	3	25	€ 2,80
PH-2500110	PH1	1/4" hex	10	25	€ 5,50
PH-2500203	PH2	1/4" hex	3	25	€ 2,80
PH-2500210	PH2	1/4" hex	10	25	€ 5,50
PH-2500303	PH3	1/4" hex	3	25	€ 2,80
PH-2500310	PH3	1/4" hex	10	25	€ 5,50

Bits - PH

Bits PH 1/4" hexagonais de 50mm. DIN 3126.



n°Stock	Medida	Quadra	Pack qtd.	Comp. mm	Preço
PH-5000103	PH1	1/4" hex	3	50	€ 3,90
PH-5000203	PH2	1/4" hex	3	50	€ 3,90
PH-5000303	PH3	1/4" hex	3	50	€ 3,90

Bits - PH

Bits PH 1/4" hexagonais de 70mm. DIN 3126.



n°Stock	Medida	Quadra	Pack qtd.	Comp. mm	Preço
PH-7000102	PH1	1/4" hex	2	70	€ 3,90
PH-7000202	PH2	1/4" hex	2	70	€ 3,90

Bits - PH

Bits PH 1/4" hexagonais de 89mm. DIN 3126.

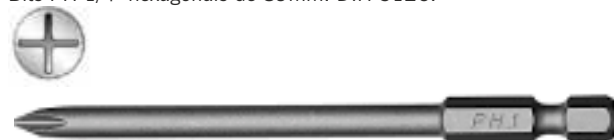

n°Stock	Medida	Quadra	Pack qtd.	Comp. mm	Preço
PH-8900101	PH1	1/4" hex	1	89	€ 5,50
PH-8900201	PH2	1/4" hex	1	89	€ 5,50



Bits Duplos - PZ

Bits duplos PZ 1/4" hexagonais de 32mm.

nºStock	Medida (1)	Medida (2)	Quadra	Pack qt.	Comp. mm	Preço
PZZ-32000305	PZ0	PZ3	1/4"Hex	5	32	€ 5,10
PZZ-32010205	PZ1	PZ2	1/4"Hex	5	32	€ 5,10

**Bits - PZ**

Bits PZ 1/4" hexagonais de 25mm. DIN 3126.

nºStock	Medida	Quadra	Pack qtd.	Comp. mm	Preço
PZ-2500103	PZ1	1/4" hex	3	25	€ 2,80
PZ-2500110	PZ1	1/4" hex	10	25	€ 5,50
PZ-2500203	PZ2	1/4" hex	3	25	€ 2,80
PZ-2500210	PZ2	1/4" hex	10	25	€ 5,50
PZ-2500303	PZ3	1/4" hex	3	25	€ 2,80
PZ-2500310	PZ3	1/4" hex	10	25	€ 5,50

**Bits - PZ**

Bits PZ 1/4" hexagonais de 50mm. DIN 3126.

nºStock	Medida	Quadra	Pack qtd.	Comp. mm	Preço
PZ-5000103	PZ1	1/4" hex	3	50	€ 3,90
PZ-5000203	PZ2	1/4" hex	3	50	€ 3,90
PZ-5000303	PZ3	1/4" hex	3	50	€ 3,90

**Bits - PZ**

Bits PZ 1/4" hexagonais de 70mm. DIN 3126.

nºStock	Medida	Quadra	Pack qtd.	Comp. mm	Preço
PZ-7000102	PZ1	1/4" hex	2	70	€ 3,90
PZ-7000202	PZ2	1/4" hex	2	70	€ 3,90

**Bits - PZ**

Bits PZ 1/4" hexagonais de 89mm. DIN 3126.

nºStock	Medida	Quadra	Pack qtd.	Comp. mm	Preço
PZ-8900101	PH1	1/4" hex	1	89	€ 5,50
PZ-8900201	PH2	1/4" hex	1	89	€ 5,50



Bits - GR

Bits GR 1/4" hexagonais de 25mm. DIN 3126, pesoço reduzido.



nºStock	Medida	Quadra	Pack qtd.	Comp. mm	Preço
GR-25002010	PH2	1/4" hex	10	25	€ 6,10
GR-25002100	PH2	1/4" hex	100	25	€ 41,00

Bits - ROB

Bits ROB 1/4" hexagonais de 25mm. DIN 3126.



nºStock	Medida	Quadra	Pack qtd.	Comp. mm	Preço
ROB-2500103	ROB 01	1/4" hex	3	25	€ 3,10
ROB-2500203	ROB 02	1/4" hex	3	25	€ 3,10
ROB-2500303	ROB 03	1/4" hex	3	25	€ 3,10

Bits - Umbrako

Bits Umbrako 1/4" hexagonais de 25mm. DIN 3126.



nºStock	Medida mm	Quadra	Pack qtd.	Comp. mm	Preço
HEX-2500203	2	1/4" hex	3	25	€ 2,90
HEX-2500303	3	1/4" hex	3	25	€ 2,90
HEX-2500403	4	1/4" hex	3	25	€ 2,90
HEX-2500503	5	1/4" hex	3	25	€ 2,90
HEX-2500603	6	1/4" hex	3	25	€ 2,90
HEX-2500803	8	1/4" hex	3	25	€ 3,60

Bits - Umbrako

Bits Umbrako 1/4" hexagonais de 50mm. DIN 3126.



nºStock	Medida mm	Quadra	Pack qtd.	Comp. mm	Preço
HEX-5000403	4	1/4" hex	3	50	€ 3,90
HEX-5000503	5	1/4" hex	3	50	€ 3,90
HEX-5000603	6	1/4" hex	3	50	€ 3,90
HEX-5000803	8	1/4" hex	3	50	€ 6,20

Bits - Umbrako

Bits Umbrako 1/4" hexagonais de 89mm. DIN 3126.



nºStock	Medida	Quadra	Pack qtd.	Comp. mm	Preço
HEX-8900401	4mm	1/4" hex	1	89	€ 5,50

Bits - TPX

Bits TPX 1/4" hexagonais de 25mm. DIN 3126.



nºStock	Medida	Quadra	Pack qtd.	Comp. mm	Preço
TPX-2501003	TPX10	1/4" hex	3	25	€ 3,70
TPX-2501503	TPX15	1/4" hex	3	25	€ 3,70
TPX-2502003	TPX20	1/4" hex	3	25	€ 3,70
TPX-2502503	TPX25	1/4" hex	3	25	€ 3,70
TPX-2502703	TPX27	1/4" hex	3	25	€ 3,70
TPX-2503003	TPX30	1/4" hex	3	25	€ 3,70
TPX-2504003	TPX40	1/4" hex	3	25	€ 3,70



Bits Duplos - TX

Bits duplos TX 1/4" hexagonais de 32mm.

nºStock	Medida (1)	Medida (2)	Quadra	Pack qt.	Comp. mm	Preço
TXX-32101505	TX10	TX15	1/4"Hex	5	32	€ 5,10
TXX-32202505	TX20	TX25	1/4"Hex	5	32	€ 5,50



Bits - TX

Bits TX 1/4" hexagonais de 25mm. DIN 3126.

nºStock	Medida	Quadra	Pack qtd.	Comp. mm	Preço
TX-2500603	TX6	1/4" hex	3	25	€ 3,00
TX-2500703	TX7	1/4" hex	3	25	€ 3,00
TX-2500803	TX8	1/4" hex	3	25	€ 3,00
TX-2500903	TX9	1/4" hex	3	25	€ 3,00
TX-2501003	TX10	1/4" hex	3	25	€ 3,00
TX-2501503	TX15	1/4" hex	3	25	€ 3,00
TX-2502003	TX20	1/4" hex	3	25	€ 3,00
TX-2502503	TX25	1/4" hex	3	25	€ 3,00
TX-2502703	TX27	1/4" hex	3	25	€ 3,00
TX-2503003	TX30	1/4" hex	3	25	€ 3,00
TX-2504003	TX40	1/4" hex	3	25	€ 3,00



Bits - TX

Bits TX 1/4" hexagonais de 50mm. DIN 3126.

nºStock	Medida	Quadra mm	Pack qtd.	Comp. mm	Preço
TX-5000803	TX8	1/4" hex	3	50	€ 3,90
TX-5001003	TX10	1/4" hex	3	50	€ 3,90
TX-5001503	TX15	1/4" hex	3	50	€ 3,90
TX-5002003	TX20	1/4" hex	3	50	€ 3,90
TX-5002503	TX25	1/4" hex	3	50	€ 3,90
TX-5002703	TX27	1/4" hex	3	50	€ 3,90
TX-5003003	TX30	1/4" hex	3	50	€ 3,90



Bits - TX

Bits TX 1/4" hexagonais de 70mm. e 89mm DIN 3126.

nºStock	Medida	Quadra	Pack qtd.	Comp. mm	Preço
TX-7001002	TX10	1/4" hex	2	70	€ 3,90
TX-7001502	TX15	1/4" hex	2	70	€ 3,90
TX-7002002	TX20	1/4" hex	2	70	€ 3,90
TX-7002502	TX25	1/4" hex	2	70	€ 3,90



nºStock	Medida	Quadra	Pack qtd.	Comp. mm	Preço
TX-8901001	TX10	1/4" hex	1	89	€ 5,50
TX-8902001	TX20	1/4" hex	1	89	€ 5,50
TX-8902501	TX25	1/4" hex	1	89	€ 5,50
TX-8903001	TX30	1/4" hex	1	89	€ 5,50



Alicates Isolados 1000v - Corte Lateral

Alicates isolados de corte lateral Mega Bite. Ângulo de corte 80°. Aço-Molibdénio cromado.

nºStock	Comprimento mm	Comprimento polegada	Capacidade corte Fio plano	Capacidade corte Fio de aço	Capacidade corte Fio de ferro	Peso g	Preço
MBV-441-6	150	6	1.6	2.0	2.5	206	€ 22,50
MBV-442-8	200	8	2.5	3.0	4.0	305	€ 31,30

**Alicates Isolados 1000v - Corte Cabos**

Alicates isolados de corte lateral Mega Bite. Ângulo de corte 80°. Aço-Molibdénio cromado. .

nºStock	Comprimento mm	Comprimento polegada	Capacidade corte mm2	Peso g	Preço
MBV-444-8	200	8	38	322	€ 30,00

**Alicate Isolado 1000v - Pontas**

Alicate isolado de pontas Mega Bite. Ângulo de corte 80°. Aço-Molibdénio cromado.

nºStock	Comprimento mm	Comprimento polegada	Capacidade corte Fio plano	Capacidade corte Fio de aço	Capacidade corte Fio de ferro	Peso g	Preço
MBV-461-8	200	8	1.5	1.8	2.8	199	€ 27,00



nºStock	Comprimento mm	Comprimento polegada	Capacidade corte Fio plano	Capacidade corte Fio de aço	Capacidade corte Fio de ferro	Peso g	Preço
MBV-463-8	200	8	1.5	1.8	2.8	199	€ 27,00



Produzidos e testados de acordo com norma EN 60900.
Certificados para trabalhos até 1000 volts AC. DIN 5749.



Alicates Isolados 1000v - Universal

Alicates isolados universais Mega Bite. Ângulo de corte 80°. Aço-Molibdénio cromado.

nºStock	Comprimento mm	Comprimento polegada	Capacidade corte Fio plano	Capacidade corte Fio de aço	Capacidade corte Fio de ferro	Peso g	Preço
MBV-451-7	175	7	1.8	2.0	3.8	225	€ 27,20
MBV-451-8	200	8	2.0	2.2	4.0	283	€ 30,00

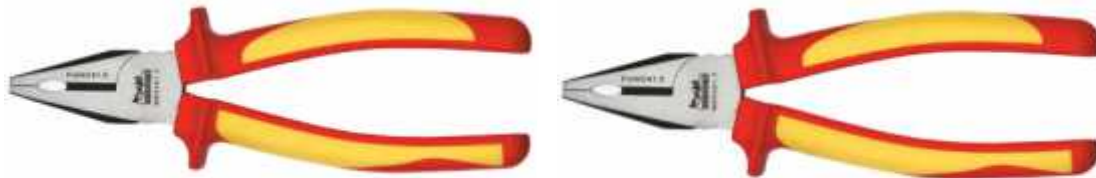

Alicates de Fixação Isolados 1000v

Alicates isolados de corte lateral Mega Bite. Com sistema de ajuste rápido.

nºStock	Comprimento mm	Comprimento polegada	Capacidade corte mm2	Peso g	Preço
MBV-482-10Q	250	10	3-38	405	€ 35,00



Alicate Isolado 1000v - Descarnador

Alicate isolado de descarnar fio. Com mola. Ângulo de corte 80°. Aço-Molibdénio cromado.

nºStock	Comprimento mm	Comprimento polegada	Capacidade corte Fio plano	Peso g	Preço
MBV-499-7	155	6	0.2 a 4.5	175	€ 25,40



1000V



MDV-9855 | € 5,50

Busca-pólos isolado 100 / 200 volts.
Comprimento total 145mm, comprimento de lâmina 70mm.



Roquete Isolado 3/8" 1000v

Roquete isolado 1000v reversível 72 dentes
 .Produzidas e testadas de acordo com norma EN 60900.
 Certificadas para trabalhos até 1000 volts AC.



n°Stock	Quadra	dentes	comp. mm	Peso g	Preço
MV-3800	3/8"	72	200	343	€ 68,00

Extensões Isoladas 3/8" 1000v

Extensões isoladas 3/8" 1000v
 Produzidas e testadas de acordo com norma EN 60900.
 Certificadas para trabalhos até 1000 volts AC. DIN3123B



n°Stock	Quadra	DIN	Descrição	Comprimento mm	Peso g	Preço
MV-380020	3/8"	3123B	extensão 3"	75	77	€ 15,60
MV-380021	3/8"	3123B	extensão 6"	150	135	€ 19,60

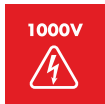

Ch. Caixa Isoladas 3/8" 1000v

Ch. caixa sextavadas isoladas 1000v 3/8" de 6 a 20mm
 Produzidas e testadas de acordo com norma EN 60900.
 Certificadas para trabalhos até 1000 volts AC. DIN3120/3124-ISO2725



n°Stock	Medida mm	L mm	D1 mm	D2 mm	Peso g	Preço
MV-380506	6	46	14.8	23	29	€ 11,00
MV-380507	7	46	15.7	23	29	€ 11,00
MV-380508	8	46	17	23	30	€ 11,00
MV-380509	9	46	18.2	23	31	€ 11,00
MV-380510	10	46	19.4	23	31	€ 11,00
MV-380511	11	46	20.7	23	32	€ 11,00
MV-380512	12	46	23	23	33	€ 11,00
MV-380513	13	46	23	23	37	€ 11,00
MV-380514	14	46	24.7	23	39	€ 11,00
MV-380515	15	46	26	23	40	€ 11,60
MV-380516	16	46	26.8	23	42	€ 11,60
MV-380517	17	46	29	23	47	€ 11,60
MV-380518	18	46	29.6	23	49	€ 11,70
MV-380519	19	46	30.7	23	53	€ 11,70
MV-380520	20	46	32.2	23	55	€ 12,40



Faca Isoladas 1000v

Faca isolada com cabo ergonómico bi-material.
Produzidas e testadas de acordo com norma EN 60900.
Certificadas para trabalhos até 1000 volts AC.

nºStock	Lâmina mm	L1 mm	L2 mm	L3 mm	Peso g	Preço
MKV-709	45	38	75	260	103	€ 19,00
MKV-709-A	45 x4	-	-	-	88	€ 17,00



Ch. Boca Isoladas 1000v

Ch. bocas isoladas 1000v.
Produzidas e testadas de acordo com norma EN 60900.
Certificadas para trabalhos até 1000 volts AC.

nºStock	Medida mm	L mm	W mm	H mm	Peso g	Preço
MPV-600507	7	7	46	93	25	€ 15,00
MPV-600508	8	8	46	109	40	€ 15,30
MPV-600509	9	8	46	109	40	€ 15,30
MPV-600510	10	8	46	119	44	€ 15,80
MPV-600511	11	8	46	129	64	€ 16,90
MPV-600512	12	9	46	129	64	€ 16,90
MPV-600513	13	10	46	169	102	€ 17,80
MPV-600514	14	10	46	169	102	€ 17,80
MPV-600515	15	11	46	176	130	€ 19,50
MPV-600516	16	11	46	176	130	€ 19,50
MPV-600517	17	11	46	176	130	€ 19,50
MPV-600518	18	12	46.6	187	158	€ 22,20
MPV-600519	19	12	46.6	187	158	€ 22,20
MPV-600520	20	13	52	207	222	€ 27,60
MPV-600521	21	13	52	207	222	€ 27,60
MPV-600522	22	13	52	207	222	€ 27,60
MPV-600523	23	14	57	242	326	€ 29,50
MPV-600524	24	14	57	242	326	€ 29,50



1000V



Chaves Torque Isolada 1000v

Chave de fenda de torque cobrindo 1-5Nm para nossas lâminas intercambiáveis VDE. Mecanismo garante que nenhum torque seja aplicado além do torque definido. Janela simples de ajustar e fácil de ler Escala Nm. Travamento de pressão para garantir que o torque definido seja mantido. Precisão de +/- 6% e está em conformidade com ISO6789. Testado individualmente e certificado no momento da fabricação. Cada chave tem o seu próprio número de certificação individual. Produzidas e testadas de acordo com norma EN 60900. Certificadas para trabalhos até 1000 volts AC.

n°Stock	Torque Nm	Quadra	Lamina mm	Peso g	Cabo	Preço
1492-TVSD	1-5	1/4"	82	215	L	€ 98,00



Cabos Isolados 1000v

Cabos isolados para laminas intermutáveis. Produzidas e testadas de acordo com norma EN 60900. Certificadas para trabalhos até 1000 volts AC.



n°Stock	Medida mm	H mm	W mm	tipo de cabo	Peso g	Preço
MDV-700	122	36.7	37	L	66	€ 8,50
MDV-710	100	23	23	S	26	€ 8,00

Lâminas Isoladas 1000v

Lâminas intermutáveis. Produzidas e testadas de acordo com norma EN 60900. Certificadas para trabalhos até 1000 volts AC.



n°Stock	Medida	Lâmina	L1 mm	H mm	W mm	Peso gr	Preço
MDV-731	3	direita	111	13	13	9	€ 4,00
MDV-732	4	RBD	151	13	13	15	€ 4,80
MDV-733	5.5	RBD	131	13	13	21	€ 5,40
MDV-734	6.5	RBD	151	13	13	28	€ 5,70
MDV-751	PH1	RBD	131	13	13	15	€ 4,80
MDV-752	PH2	RBD	151	13	13	26	€ 5,70
MDV-771	PZ1	RBD	131	13	13	15	€ 4,80
MDV-772	PZ2	RBD	151	13	13	26	€ 5,70

1000V



Cabo+Lâminas Isoladas 1000v MDV-909N | € 38,50

Cabo+ laminas intermutáveis +saco transporte. Produzidas e testadas de acordo com norma EN 60900. Certificadas para trabalhos até 1000 volts AC.



composto por cabo MDV-700 e lâminas intermutáveis:
MDV731+MDV732+MDV733+MDV734+
MDV751+MDV752+MDV771+MDV772



MDV-906-N | € 35,80

Jogo de 6 chaves isoladas 1000v, fornecido em tabuleiro plástico.
Chaves certificadas para trabalhos até 1000 volts AC. Conforme EN 60900.

Chaves	fendas	2.5x75mm, 3.0x100mm, 4.0x100mm, 5.5x125mm
	PH	PH1x80mm, PH2x100mm



TV-18-N | € 258,00

Jogo 18 peças 1000v, fornecido em mala de ferramenta Teng Tools.
Ferramenta certificada para trabalhos até 1000 volts AC. Conforme EN 60900.

Chaves	fendas	2.5x75mm, 3.0x100mm, 4.0x100mm, 5.5x125mm, 6.5x150mm
	PH	PH0x60mm, PH1x80mm, PH2x100mm, PH3x150mm
	PZ	PZ0x60mm, PZ1x80mm, PZ2x100mm, PZ3x150mm
Alicates		corde lateral 6", corte lateral 8", universal 8", pontas 8", descarnador 7"

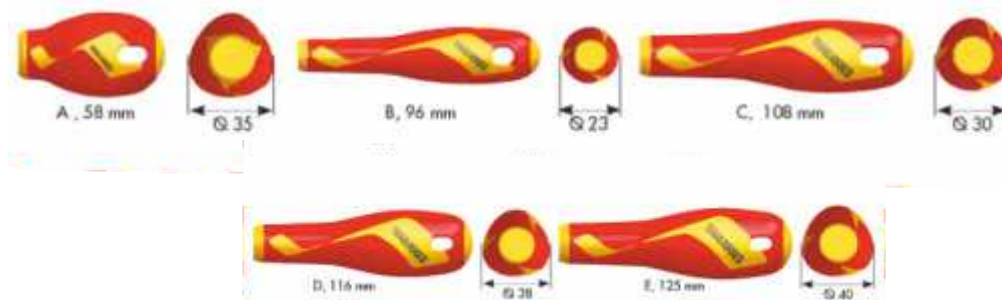
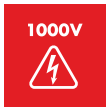

Chaves Isoladas 1000v - Fendas

Chaves de fendas isoladas

Produzidas e testadas de acordo com norma EN 60900.

Certificadas para trabalhos até 1000 volts AC.



nºStock	a mm	b mm	Lâmina	L1 mm	L2 mm	Peso g	Cabo	Preço
MDV-820-N	0.4	2.5	isolada	75	171	49	S	€ 5,50
MDV-822-N	0.5	3.0	isolada	100	196	56	S	€ 5,50
MDV-823-N	0.6	3.5	isolada	100	196	58	S	€ 5,70
MDV-824-N	0.8	4.0	isolada	100	208	60	M	€ 6,90
MDV-826-N	1.0	5.5	isolada	125	233	89	M	€ 7,60
MDV-828-N	1.2	6.5	isolada	150	266	135	L	€ 9,40

Chaves Isoladas 1000v - PH

Chaves isoladas PH

Produzidas e testadas de acordo com norma EN 60900.

Certificadas para trabalhos até 1000 volts AC.



nºStock	Medida	Lâmina	L1 mm	L2 mm	Peso g	Cabo	Preço
MDV-840-N	PH0	isolada	60	156	49	S	€ 5,40
MDV-842-N	PH1	isolada	80	188	54	M	€ 7,00
MDV-844-N	PH2	isolada	100	216	118	L	€ 9,00
MDV-846-N	PH3	isolada	150	275	177	XL	€ 12,20

Chaves Isoladas 1000v - PZ

Chaves isoladas PZ

Produzidas e testadas de acordo com norma EN 60900.

Certificadas para trabalhos até 1000 volts AC.

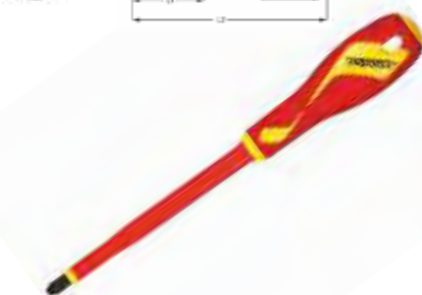
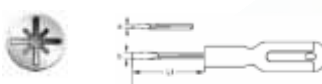

nºStock	Medida	Lâmina	L1 mm	L2 mm	Peso g	Cabo	Preço
MDV-860-N	PZ0	isolada	60	156	49	S	€ 6,20
MDV-862-N	PZ1	isolada	80	188	54	M	€ 6,90
MDV-864-N	PZ2	isolada	100	216	118	L	€ 8,90
MDV-866-N	PZ3	isolada	150	275	177	XL	€ 12,80

Chaves Isoladas 1000v - ROB

Chaves isoladas ROB

Produzidas e testadas de acordo com norma EN 60900.

Certificadas para trabalhos até 1000 volts AC.



nºStock	Medida	Lâmina	L1 mm	L2 mm	Peso g	Cabo	Preço
MDV-802-N	ROB 2	isolada	100	216	118	L	€ 8,80



Chaves Isoladas 1000v RBD - Fendas

Chaves de fendas isoladas com lâmina de **diâmetro reduzido** (RBD)
Produzidas e testadas de acordo com norma EN 60900.
Certificadas para trabalhos até 1000 volts AC.

nºStock	a mm	b mm	c mm	d mm	Lâmina	L1 mm	L2 mm	Peso g	Preço
MDV-724-N	0.8	4.0	15	31.5	RBD	101	210	51	€ 7,50
MDV-726-N	1.0	5.5	15	31.5	RBD	127	235	66	€ 8,30



Chaves Isoladas 1000v RBD - PH

Chaves isoladas PH com lâmina de **diâmetro reduzido** (RBD)
Produzidas e testadas de acordo com norma EN 60900.
Certificadas para trabalhos até 1000 volts AC.

nºStock	Medida mm	b mm	c mm	d mm	Lâmina	L1 mm	L2 mm	Peso g	Preço
MDV-742-N	PH1	4.5	18	30.0	RBD	81	190	51	€ 7,80
MDV-744-N	PH2	6.0	18	30.5	RBD	100	217	95	€ 9,70



Chaves Isoladas 1000v RBD - PZ

Chaves isoladas PZ com lâmina de **diâmetro reduzido** (RBD)
Produzidas e testadas de acordo com norma EN 60900.
Certificadas para trabalhos até 1000 volts AC.

nºStock	Medida mm	b mm	c mm	d mm	Lâmina	L1 mm	L2 mm	Peso g	Preço
MDV-762-N	PZ1	4.5	18	30.0	RBD	81	190	51	€ 7,80
MDV-764-N	PZ2	6.0	18	30.5	RBD	100	217	95	€ 9,70



1000V



Chaves Isoladas 1000v - Combinada

Chaves isoladas **Combinadas**
Produzidas e testadas de acordo com norma EN 60900.
Certificadas para trabalhos até 1000 volts AC.

nºStock	Medida	Lâmina	L1 mm	L2 mm	Peso g	Cabo	Preço
MDV-844-NF	fenda/PH2	isolada	100	216	118	L	€ 9,00
MDV-864-NF	fenda/PZ2	isolada	100	216	118	L	€ 9,00



445-W | € 84,00

Jogo de 5 alicates Mega Bite, fornecido em estojo.

Contém: mini alicate de corte lateral de 4 ½", alicate de corte lateral 6", alicate universal 7", alicate de pontas 8" e alicate bomba de água de 10".



Alicates Mega Bite - Universais

Alicates universais Mega Bite. Ângulo de corte 80°. Aço-Molibdênio cromado. Conforme DIN 5746.

nºStock	Tipo de cabo	Comprimento mm	Comprimento polegada	Cap. corte Fio plano	Cap. corte Fio de aço	Cap. corte Fio de ferro	Peso g	Preço
MB-451-7	vinil	180	7"	1.8	2.0	3.8	195	€ 17,60
MB-451-8	vinil	200	8"	2.0	2.2	4.0	253	€ 20,90
MB-452-6	vinil	160	6"	1.6	1.8	3.4	210	€ 18,90
MB-452-7	vinil	180	7"	1.8	2.0	3.8	210	€ 19,90
MB-452-8	vinil	200	8"	2.0	2.2	4.0	240	€ 23,10
MB-452-9	vinil	225	9"	2.0	2.2	4.0	380	€ 28,60
MB-452-6T	TPR	160	6"	1.6	1.8	3.4	200	€ 20,10
MB-452-7T	TPR	180	7"	1.8	2.0	3.8	220	€ 22,00
MB-452-8T	TPR	200	8"	2.0	2.2	4.0	266	€ 24,90



Alicates Mega Bite - Pontas direitas

Alicates de pontas Mega Bite. Ângulo de corte 80°. Aço-Molibdênio cromado. Conforme DIN 5745.

nºStock	Tipo de cabo	Comprimento mm	Comprimento polegada	Cap. corte Fio plano	Cap. corte Fio de aço	Cap. corte Fio de ferro	Peso g	Preço
MB-461-5	vinil	140	5"	1.0	1.5	2.5	130	€ 16,60
MB-461-6	vinil	160	6"	1.0	1.5	2.5	130	€ 16,70
MB-461-8	vinil	200	8"	1.5	1.8	2.8	180	€ 20,10
MB-461-6T	TPR	160	6"	1.0	1.5	2.5	160	€ 18,70
MB-461-8T	TPR	200	8"	1.5	1.8	2.8	200	€ 21,70



Alicates de Pontas Mega Bite - Pontas curvas

Alicates de ponta curva 45° Mega Bite. Ângulo de corte 80°. Aço-Molibdénio cromado. Conforme DIN 5745.

nºStock	Tipo de cabo	Comprimento mm	Comprimento polegada	Cap. corte Fio plano	Cap. corte Fio de aço	Cap. corte Fio de ferro	Peso g	Preço
MB-463-5	vinil	140	5	1.0	1.5	2.5	150	€ 18,50
MB-463-6	vinil	160	6	1.0	1.5	2.5	160	€ 19,00
MB-463-8	vinil	200	8	1.5	1.8	2.8	167	€ 20,30



MB-463-8T	TPR	200	8	1.5	1.8	2.8	186	€ 21,80
------------------	-----	-----	---	-----	-----	-----	-----	---------



Alicates de Pontas c/ mola Mega Bite - Pontas redondas

Alicates de ponta redonda Mega Bite, com mola de retorno. Aço-Molibdénio cromado.

nºStock	Cabo	Comp. mm	Comp.	Peso	Preço
MB-465-6	vinil	150	6	170	€ 18,70

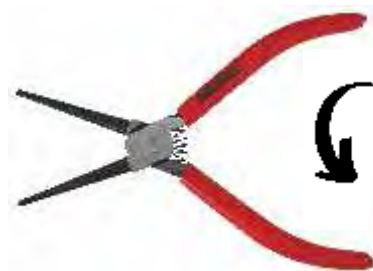

Alicates de Pontas Mega Bite - Pontas chatas

Alicates de ponta chata Mega Bite. Aço-Molibdénio cromado. Conforme DIN 5745.

nºStock	Cabo	Comp. mm	Comp.	Peso	Preço
MB-464-6	vinil	165	6	120	€ 16,70



MB-464-6T	TPR	165	6	120	€ 17,00
------------------	-----	-----	---	-----	---------



Cabo em Vinil

Cabo em TPR duplo componente



Alicates Mega Bite - Corte Lateral

Alicates de corte lateral Mega Bite. Ângulo de corte 80°. Aço-Molibdénio cromado. DIN 5749.

nºStock	Tipo de cabo	Comprimento mm	Comprimento polegada	Cap. corte Fio piano	Cap. corte Fio de aço	Cap. corte Fio de ferro	Cap. corte Fio de cobre	Peso g	Preço
MB-441-5	vinil	135	5	1.5	1.8	2.3	4.0	111	€ 14,90
MB-441-6	vinil	155	6	1.6	2.0	2.5	4.0	150	€ 16,80
MB-441-5T	TPR	135	5	1.5	1.8	2.3	4.0	126	€ 16,90
MB-441-6T	TPR	155	6	1.6	2.0	2.5	4.0	176	€ 18,90



nºStock	Tipo de cabo	Comprimento mm	Comprimento polegada	Cap. corte Fio piano	Cap. corte Fio de aço	Cap. corte Fio de ferro	Cap. corte Fio de cobre	Peso g	Preço
MB-442-5	vinil	140	5	1.5	1.8	2.3	4.0	180	€ 17,90
MB-442-6	vinil	160	6	2.0	2.5	3.8	4.0	180	€ 18,00
MB-442-7	vinil	180	7	2.0	2.5	4.0	4.0	220	€ 20,50
MB-442-8	vinil	200	8	2.5	3.0	4.0	4.0	240	€ 21,20
MB-442-6T	TPR	160	6	2.0	2.5	3.8	4.0	199	€ 19,20
MB-442-8T	TPR	200	8	2.5	3.0	4.0	4.0	275	€ 23,70



Alicate Mega Bite - Corte Lateral 14°

Alicate de corte lateral Mega Bite com ângulo de 14°. Ângulo de corte 80°. Aço-Molibdénio cromado. DIN 5749.

nºStock	Tipo de cabo	Comprimento mm	Comprimento polegada	Cap. corte Fio piano	Cap. corte Fio de aço	Cap. corte Fio de ferro	Cap. corte Fio de cobre	Peso g	Preço
MB-442B-8T	TPR	200	8	2.5	3.0	4.0	4.0	275	€ 24,00



Alicate Mega Bite com Mola - Corte Lateral

Alicate de corte lateral Mega Bite com mola de retorno. Ângulo de corte 80°. Aço-Molibdénio cromado. DIN 5749.

nºStock	Tipo de cabo	Comprimento mm	Comprimento polegada	Cap. corte Fio plano	Cap. corte Fio de aço	Cap. corte Fio de ferro	Cap. corte Fio de cobre	Peso g	Preço
MB-442-7S	vinil	180	7	2.0	2.5	4.0	4.0	250	€ 25,80

**Alicates - Corta Arames**

Alicates corta arames, com mola de retorno. Para corte de abraçadeiras plásticas e de latão. Aço-molibdénio.

nºStock	Cabo	Comp. mm	Comp.	Peso g	Preço
MB-541-5	Vinil	125	5	100	€ 22,50
MB-541-6	Vinil	150	6	143	€ 24,20
MB-541-7	Vinil	180	7	227	€ 29,50

**Alicates Mega Bite - Corta Cabos**

Alicates corta cabos Mega Bite, para corte de cabos de cobre e alumínio. Aço carbono de alta densidade.

nºStock	Cabo	Comp. mm	Comp.	Cap. Corte mm	Peso g	Preço
MB-444-6	vinil	160	6"	22	181	€ 21,10
MB-444-8	vinil	200	8"	38	322	€ 23,20
MB-444-10	vinil	250	10"	60	381	€ 35,80
MB-444-8T	TPR	208	8"	38	347	€ 25,20

**Alicate Industrial - Corta Cabos**

Alicate industrial corta cabos, para corte de cabos eléctricos de cobre e alumínio. Aço Cr-Mo.

nºStock	Cabo	Comp. mm	Comp.	Cap. Corte mm	Peso g	Preço
MB-445-10	vinil	250	10"	60	412	€ 38,60



Alicate - Corta Cabo Super

Alicate corta cabo, com mola de retorno. Gumes especiais que proporcionam um corte uniforme. Aço-carbono de alta densidade.

nºStock	Tipo de cabo	Comprimento mm	Comprimento polegada	Cap. corte Fio de aço	Cap. corte Fio inox	Cap. corte Fio mola	Peso g	Preço
498-7N	vinil	190	7	7mm	4mm	2.5mm	306	€ 24,50



Alicates - Corte (Heavy Duty)

Alicates corte. Aço-molibdénio, gumes temperados (HRC58) com ângulo de 80°. Com mola de retorno e travão.

nºStock	Tipo de cabo	Comprimento mm	Comprimento polegada	Cap. corte cobre mm	Cap. corte Fios de Alumínio	Peso g	Preço
496	TPR	250	12"	12	12	280	€ 25,60



Alicates - Corte

Alicates corte. Aço-molibdénio, gumes temperados (HRC58) com ângulo de 80°. Com mola de retorno e travão.

nºStock	Tipo de cabo	Comprimento mm	Comprimento polegada	Cap. corte Fio plano	Cap. corte Fio de aço	Cap. corte Fio de ferro	Peso g	Preço
BC-408	vinil	200	8"	3.6	4.0	5.2	260	€ 41,30
BC-408T	TPR	200	8"	3.6	4.0	5.2	275	€ 42,60



Alicates - Corte Frontal

Alicates de corte frontal. Aço-molibdénio cromado. Conforme DIN 5748.

nºStock	Tipo de cabo	Comprimento mm	Comprimento polegada	Cap. corte Fio de aço	Cap. corte Fio de ferro	Cap. corte Fio de cobre	Peso g	Preço
MB-448-6	vinil	160	6	1.6	1.8	3.4	200	€ 23,50
MB-448-8	vinil	200	8	1.6	1.8	3.4	250	€ 29,50



Alicates - Turquesa

Turquesas com corte a 85°.

nºStock	Tipo de cabo	Comprimento mm	Comprimento polegada	Cap. corte Fio de aço	Cap. corte Fio de ferro	Peso g	Preço
MB-489-7	vinil	180	7	1.6	2.0	262	€ 22,90
MB-489-8	vinil	200	8	1.8	2.0	283	€ 27,60



Alicates - Turquesa

Turquesas em aço-molibdénio cromado.

nºStock	Tipo de cabo	Comprimento mm	Comprimento polegada	Cap. corte Fio de aço	Cap. corte Fio de ferro	Cap. corte Fio de cobre	Peso g	Preço
MB-449-9	vinil	220	9	1.8	2.0	3.4	355	€ 24,00
MB-449-10	vinil	250	10	2.0	2.2	3.8	408	€ 25,90
MB-449-11	vinil	280	11	2.5	3.0	4.0	492	€ 26,80



Alicates de Pontas Mega Bite - Longo Alcance

Alicates de pontas de longo alcance 11", com mola de retorno.
Aço endurecido HRC 43-48.

nºStock	Ponta	Comp. mm	Comp. «	Peso g	Preço
AT-096	-	275	11	300	€ 21,00
AT-097	45°	275	11	300	€ 21,00
AT-094	90°	275	11	325	€ 21,60



281



Alicates Mega Bite - Bomba de Água

Alicates bomba de água Mega Bite. Boca serrilhada. Aço-vanádio cromado.

nºStock	Cabo	Comp. mm	Comp.	Cap. mm	Peso g	Preço
MB-481-7	vinil	180	7	3-25	159	€ 19,70
MB-481-10	vinil	250	10	3-25	175	€ 22,50
MB-481-7T	TPR	180	7	3-25	344	€ 20,20
MB-481-10T	TPR	250	10	3-25	371	€ 24,10



Alicates Bomba de Água - Ajuste Rápido

Alicates bomba de água Mega Bite. Com sistema de ajuste rápido. Aço-vanádio cromado.

nºStock	Cabo	Comp. mm	Comp.	Cap. mm	Peso g	Preço
MB-481-10Q	vinil	250	10	3-38	380	€ 33,40
MB-481-10TQ	TPR	250	10	3-38	405	€ 34,70



Alicates Bomba de Água - Ajuste Automático

Alicates bomba de água Mega Bite. Com sistema de ajuste automático. Aço-vanádio cromado.

nºStock	Cabo	Comp. mm	Comp.	Cap. mm	Peso g	Preço
MB-482-7Q	vinil	190	7	3-25	182	€ 27,20
MB-482-10Q	vinil	250	10	3-38	335	€ 29,70
MB-482-10TQ	TPR	250	10	3-38	359	€ 31,00



Alicates Mega Bite - Bomba de Água

Alicates bomba de água Mega Bite, Junta com ranhuras maquinadas para maior estabilidade. Aço-vanádio cromado.

nºStock	Cabo	Comp. mm	Comp.	Cap. mm	Peso g	Preço
MB-410	vinil	250	10	45	425	€ 20,00
MB-412	vinil	300	12	60	600	€ 30,50
MB-416	vinil	400	16	90	1330	€ 48,25



Alicate Mega Bite - Descarnador

Alicate descarnador Mega Bite. Com parafuso de ajuste e mola de retorno. Aço-carbono.

nºStock	Cabo	Comp. mm	Comp.	Cap. mm	Peso g	Preço
MB-499-7T	TPR	155	6	0.2 a 4.5	175	€ 20,50



Alicate - Torcedor

Alicate para torcer arame, com corte lateral até 1.0mm. Aço-carbono de alta densidade.

nºStock	Comp. mm	Comp.	Peso g	Preço
AT-605	150	6	250	€ 41,00



480 | € 15,40

Alicate de freios modular, com quatro cabeças de pontas magnéticas.



Cabo	Reversível, mola de retorno, travão
Cabeças	(magnéticas) pontas internas/externas 1.2mm
	pontas internas/externas 1.5mm
	pontas internas/externas curva 45°
	pontas internas/externas curva 90°

Alicates de Freios

- Mola de retorno invisível para facilitar a operação
- Para uso com anéis de retenção ou anéis elásticos internos
- Pontas de aço para rolamentos para aplicações pesadas
- Ângulo de ponta antiderrapante
- Construção em cromo vanádio
- Alça de vinil para facilitar o uso em bolsos ou bolsas de ferramentas
- DIN 5256

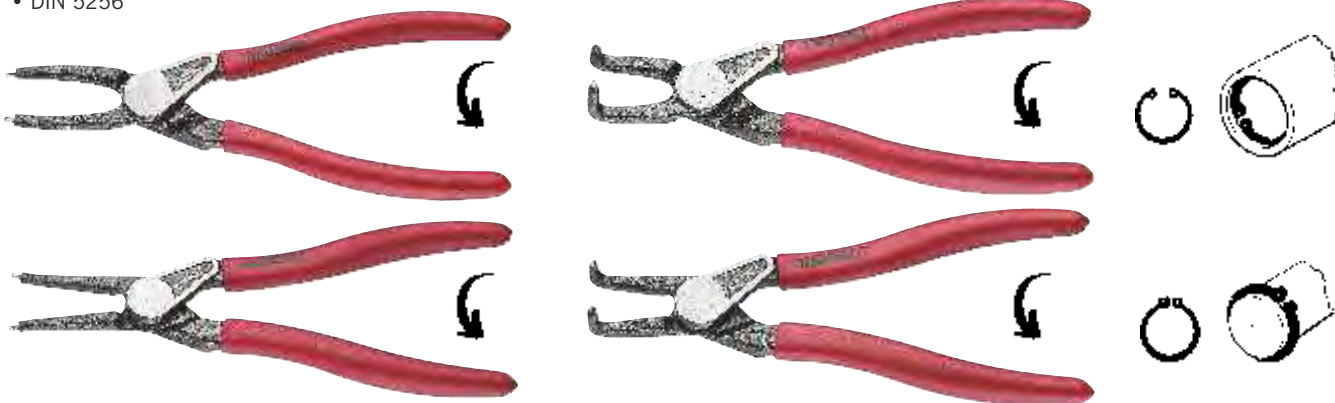

nºStock	Tipo de cabo	Comprimento mm	Comprimento polegada	Tipo	Ponta mm	Capacidade mm	Peso g	Preço
MBE-470-5	vinil	140	5"	recto/interno	1.3	12,25	80	€ 22,30
MBE-471-5	vinil	125	5"	curvo/interno	1.3	12,25	80	€ 22,30
MBE-472-5	vinil	140	5"	recto/externo	1.3	12,25	90	€ 22,30
MBE-473-5	vinil	125	5"	curvo/externo	1.3	12,25	90	€ 22,30

MBE-470-7	vinil	185	7"	recto/interno	1.8	19-60	150	€ 23,90
MBE-471-7	vinil	170	7"	curvo/interno	1.8	19-60	150	€ 23,90
MBE-472-7	vinil	185	7"	recto/externo	1.8	19-60	170	€ 23,90
MBE-473-7	vinil	170	7"	curvo/externo	1.8	19-60	170	€ 23,90

MBE-470-9	vinil	235	9"	recto/interno	2.3	40-100	295	€ 37,00
MBE-471-9	vinil	215	9"	curvo/interno	2.3	40-100	295	€ 37,00
MBE-472-9	vinil	235	9"	recto/externo	2.3	40-100	310	€ 37,00
MBE-473-9	vinil	215	9"	curvo/externo	2.3	40-100	310	€ 37,00



Alicates de Freios - Recto Interno

Alicates de freios com mola de retorno. Aço-vanádio cromado. Conforme DIN 5254.



n°Stock	Tipo de cabo	Comprimento mm	Comprimento polegada	Tipo	Ponta mm	Capacidade mm	Peso g	Preço
MB-470-5	vinil	130	5	recto/interno	1.25	10 a 25	100	€ 16,50
MB-470-7	vinil	175	7	recto/interno	1.8	19 a 60	134	€ 17,90
MB-470-9	vinil	225	9	recto/interno	2.25	40 a 100	160	€ 27,60

Alicates de Freios - Curvo Interno

Alicates de freios com mola de retorno. Aço-vanádio cromado. Conforme DIN 5254.



n°Stock	Tipo de cabo	Comprimento mm	Comprimento polegada	Tipo	Ponta mm	Capacidade mm	Peso g	Preço
MB-471-5	vinil	130	5	Bent/inner	1.25	10 a 25	100	€ 16,50
MB-471-7	vinil	175	7	Bent/inner	1.8	19 a 60	134	€ 17,90
MB-471-9	vinil	225	9	Bent/inner	2.25	40 a 100	160	€ 27,60

Alicates de Freios - Recto Externo

Alicates de freios com mola de retorno. Aço-vanádio cromado. Conforme DIN 5254.



n°Stock	Tipo de cabo	Comprimento mm	Comprimento polegada	Tipo	Ponta mm	Capacidade mm	Peso g	Preço
MB-472-5	vinil	130	5	recto/externo	1.25	10 a 25	100	€ 16,50
MB-472-7	vinil	175	7	recto/externo	1.8	19 a 60	134	€ 17,90
MB-472-9	vinil	225	9	recto/externo	2.25	40 a 100	160	€ 27,60

Alicates de Freios - Curvo Externo

Alicates de freios com mola de retorno. Aço-vanádio cromado. Conforme DIN 5254.



n°Stock	Tipo de cabo	Comprimento mm	Comprimento polegada	Tipo	Ponta mm	Capacidade mm	Peso g	Preço
MB-473-5	vinil	130	5	curvo/externo	1.25	10 a 25	100	€ 16,50
MB-473-7	vinil	175	7	curvo/externo	1.8	19 a 60	134	€ 17,90
MB-473-9	vinil	225	9	curvo/externo	2.25	40 a 100	160	€ 27,60



Alicates Electrónica - Corte

Alicate de electrónica corte lateral, com mola de retorno, corte de 68°. Aço-carbono de alta densidade.



Corte lateral

nºStock	Cabo	Comp. mm	Comp.	Cap. mm	Peso g	Preço
MBM-441	vinil	125	5	0.8	67	€ 17,50



Corte frontal

nºStock	Cabo	Comp. mm	Comp.	Cap. mm	Peso g	Preço
MBM-449	vinil	110	4½"	0.8	70	€ 17,50



Pontas

nºStock	Cabo	Comp. mm	Comp.	Cap. mm	Peso g	Preço
MBM-461	vinil	125	5	0.8	81	€ 17,50



Pontas chatas

nºStock	Cabo	Comp. mm	Comp.	Peso g	Preço
MBM-464	vinil	125	5	85	€ 17,50



Pontas Redondas

nºStock	Cabo	Comp. mm	Comp.	Peso g	Preço
MBM-467	vinil	125	5	71	€ 20,30



Pontas (agulha)

nºStock	Cabo	Comp. mm	Comp.	Peso g	Preço
MBM-468		150	6"	75	€ 20,30



Pontas curvas

nºStock	Cabo	Comp. mm	Comp.	Peso g	Preço
MBM-469	vinil	150	6"	78	€ 20,30



Alicate - Pontas t/tesoura

Pinça de pontas com bloqueio a três posições.
Aço temperado, acabamento acetinado.



nºStock	Comp. mm	Ponta	Peso g	Preço
SLP-1160	160	recta	43	€ 30,00
SLP-2180	180	recta	45	€ 32,60
SLP-3160	160	curva	50	€ 29,90
SLP-3180	180	curva	58	€ 34,90

Pinças

Pinças em aço inox temperado, acabamento acetinado.



nºStock	Comp. mm	Ponta	Peso g	Preço
TW-1160	160	recta, serrilhada	37	€ 15,90
TW-1180	180	recta, serrilhada	37	€ 17,45
TW-2125	125	curva, lisa	29	€ 18,20
TW-2160	160	curva, lisa	42	€ 41,00
TW-2180	170	agulha em Z	35	€ 41,00



Alicates de Fixação

Alicates de fixação de boca curva ponta chata, com corte. Bloqueio automático e parafuso de ajuste. Aço-vanádio cromado.

nºStock	Comp. mm	Comp.	Cap. mm	Peso g	Preço
401-4	100	4	25	75	€ 11,90
401-5	125	5	28	180	€ 12,50
401-7	180	7	38	345	€ 14,50
401-10	250	10	47	514	€ 16,90
401-12	300	12	50	680	€ 16,90



Alicates de Fixação

Alicates de fixação de boca chata, com corte. Bloqueio automático e parafuso de ajuste. Aço-vanádio cromado.

nºStock	Comp. mm	Comp.	Cap. mm	Peso g	Preço
401-10-F	250	10	45	527	€ 21,60
401-12-F	300	12	52	693	€ 21,60



Botão de libertação rápida



Garras de aperto com corte

402 | € 28,50

Jogo de 2 alicates de fixação. Bloqueio automático e parafuso de ajuste.

Alicates de fixação 10" (401-10) , 6" de ponta longa (404-6)



Alicates de Fixação - Pontas

Alicates de fixação de pontas, com corte. Bloqueio automático e parafuso de ajuste. Aço-vanádio cromado.

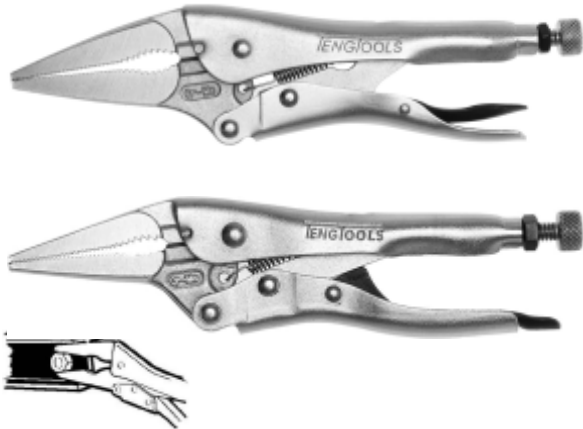

nºStock	Comp. mm	Comp.	Cap. mm	Peso g	Preço
404-4	100	4	35	180	€ 11,90
404-6	155	6	35	197	€ 12,90
404-9	230	9	70	380	€ 16,60
404-6-S**	160	6	35	185	€ 12,90

** Sistema de desbloqueio fácil acção a uma mão.

Alicates de Fixação - Tipo C

Alicates de fixação tipo C. Bloqueio automático e parafuso de ajuste. Aço-vanádio cromado. Modelos **S** com sistema de desbloqueio fácil, acção a uma mão.



nºStock	Comp. mm	Comp.	Cap. mm	Boca prof. mm	Boca alt. mm	Peso g	Preço
406	280	11	80	70	100	772	€ 22,70



nºStock	Comp. mm	Comp.	Cap. mm	Boca prof. mm	Boca alt. mm	Peso g	Preço
406-6	172	6	0-50	40	60	235	€ 16,00



nºStock	Comp. mm	Comp.	Cap. mm	Boca prof. mm	Boca alt. mm	Peso g	Preço
406-6-S	172	6	0-50	40	60	235	€ 16,00
406-S	285	11	0-80	70	100	760	€ 22,80



nºStock	Comp. mm	Comp.	Cap. mm	Boca prof. mm	Boca alt. mm	Peso g	Preço
418-S	455	6	0-160	235	100	1200	€ 49,90



Alicates de Fixação - Tipo C (pontas chatas)

Alicates de fixação tipo C pontas chatas. Bloqueio automático e parafuso de ajuste.

Aço-vanádio cromado. Modelos **S** com sistema de desbloqueio fácil, acção a uma mão.

nºStock	Comp. mm	Comp.	Cap. mm	Boca prof. mm	Boca alt. mm	Peso g	Preço
406-P	280	11	80	70	100	772	€ 27,00



nºStock	Comp. mm	Comp.	Cap. mm	Boca prof. mm	Boca alt. mm	Peso g	Preço
406-6-P	172	6	0-50	40	60	235	€ 17,90



nºStock	Comp. mm	Comp.	Cap. mm	Boca prof. mm	Boca alt. mm	Peso g	Preço
406-6-SP	172	6	0-50	40	60	235	€ 18,20
406-SP	285	11	0-80	70	100	760	€ 26,2



nºStock	Comp. mm	Comp.	Cap. mm	Boca prof. mm	Boca alt. mm	Peso g	Preço
418-SP	455	6	0-160	235	100	1200	€ 49,90

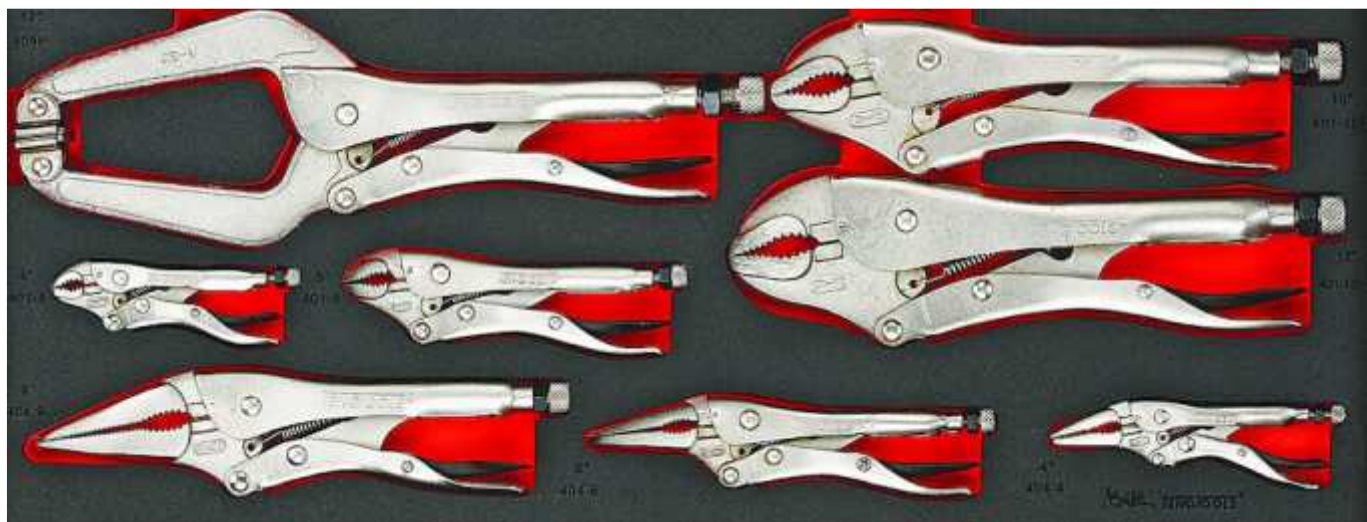

Alicates de Fixação - Soldadura

Alicates de fixação para soldadura. Bloqueio automático e parafuso de ajuste.

Aço-vanádio cromado. Modelos **S** com sistema de desbloqueio fácil, acção a uma mão.



nºStock	Comp. mm	Comp.	Cap. mm	Peso g	Preço
407	230	9	65	580	€ 20,50



nºStock	Comp. mm	Comp.	Cap. mm	Boca prof. mm	Peso g	Preço
407-AS	270	11	90	85	855	€ 26,00

Alicates de Fixação - Chapa

Alicates de fixação para chapa. Bloqueio automático e parafuso de ajuste.

Aço-vanádio cromado.



nºStock	Comp. mm	Comp.	Cap. mm	Peso g	Preço
408	230	8	65	580	€ 18,50

Alicates de Fixação - Tipo C Longo

Alicates de fixação tipo C longo. Bloqueio automático e parafuso de ajuste.

Aço-vanádio cromado. Modelos **S** com sistema de desbloqueio fácil, acção a uma mão.



nºStock	Comp. mm	Comp.	Cap. mm	Peso g	Preço
409-P	300	12	65	580	€ 26,90



nºStock	Comp. mm	Comp.	Cap. mm	Peso g	Preço
409-SP	300	12	88	740	€ 27,30

Alicates de Fixação - Mesa de Máquina

Alicates de fixação para mesa de máquina. Bloqueio automático e parafuso de ajuste.

Aço-vanádio cromado. Modelos **S** com sistema de desbloqueio fácil, acção a uma mão..



nºStock	Comp. mm	Cap. mm	Ø Furo mm	Peso g	Preço
410-P	320	65	10.0	580	€ 30,00



nºStock	Comp. mm	Cap. mm	Ø Furo mm	Peso g	Preço
410-SP	230	65	4.0	580	€ 30,00



TC-AV4 | € 199,00

Torno Aço forjado de 4"-100mm.

Mordentes paralelos e em formato V. Alta resistência em aço S45S (dureza HRC45-50) e força máxima de aperto 300kg/cm².**Grampos F**

Grampos tipo com manivela de aperto em T e com manivela de aperto flexível a 180°.

nºStock	Alcance mm	Prof. mm	Barra mm	Peso g	Preço
CMF-16	160	80	16.5 x 7.5	0.48	€ 26,30
CMF-20	200	100	19.5 x 9.5	0.9	€ 38,40
CMF-25	250	120	22 x 10.5	1.21	€ 42,30
CMF-30	300	140	25 x 12	1.80	€ 52,40
CMF-35	300	120	25 x 12	1.72	€ 452,40

nºStock	Alcance mm	Prof. mm	Barra mm	Peso g	Preço
CMF-16T	160	80	16.5 x 7.5	0.57	€ 34,70
CMF-20T	200	100	19.5 x 9.5	1.01	€ 41,90
CMF-25T	250	120	22 x 10.5	1.33	€ 50,20
CMF-30T	300	140	25 x 12	1.96	€ 61,00
CMF-35T	300	100	25 x 12	1.14	€ 61,00

**Grampos com Alavanca**

Grampo com alavanca, para maior pressão e aperto rápido. A alavanca tipo roque evita pressão excessiva e vibrações, ergonómica com gatilho de desaperto.

nºStock	Força Max.	Alcance mm	Prof. mm	Barra mm	Peso g	Preço
CMF-Q-20	3432	200	100	19.5 x 9.5	1130	€ 65,40
CMF-Q-25	3922	250	120	22.0 x 10.5	1500	€ 74,90
CMF-Q-30	4903	300	140	25.0 x 12.0	2260	€ 92,00
CMF-Q-40	5393	400	120	25.0 x 12.0	2400	€ 98,00



Grampos

Grampo tipo F profissional, com um suporte fixo e um deslizante equipado numa calha de aço perfilado e galvanizado. Parafuso de aperto com cabo ergonómico bi-material.



nºStock	Força Max. Nm	Alcance mm	Prof. mm	Barra mm	Peso g	Preço
CMD-12	1961	120	60	20.0 x 5.0	430	€ 17,90
CMD-16	2648	160	80	25.0 x 6.0	750	€ 22,70
CMD-20	3922	200	100	27.0 x 7.0	1120	€ 32,30
CMD-25	4903	250	120	29.0 x 9.0	1500	€ 35,90
CMD-30	4903	300	120	29.0 x 9.0	1590	€ 39,50
CMD-30A	5393	300	140	32.0 x 10.0	2050	€ 48,10
CMD-40	5393	400	140	32.0 x 10.0	2260	€ 38,70
CMD-40A	5393	400	175	32.0 x 10.0	2330	€ 43,70
CMD-50	4903	500	120	29.0 x 9.0	1940	€ 33,70
CMD-80	4903	800	120	29.0 x 9.0	2480	€ 42,20

Grampos de Aperto Rápido

Grampos de aperto rápido com um design exclusivo e uma poderosa barra de alavanca que facilita a aplicação da força de aperto correta. A alavanca montada na parte superior torna o grampo rápido e confortável de usar, é igualmente rápido e fácil de desmontar. Punho FRP bi-material.



nºStock	Força Max. Nm	Alcance mm	Prof. mm	Peso g	Preço
CMQ-L-150	1780	150	80	670	€ 27,70
CMQ-L-300	1780	300	80	780	€ 30,00
CMQ-L-450	1780	450	80	900	€ 35,30

F

Grampos de Aperto Rápido

Grampos de aperto rápido, com um design exclusivo e uma poderosa barra de alavanca que facilita a aplicação da força de aperto correta. A alavanca montada no fundo torna o grampo rápido e confortável de usar, é igualmente rápido e fácil de desmontar. Punho FRP bi-material.



Botão libertação rápida

Uso Inverso

nºStock	Força Max. Nm	Alcance mm	Prof. mm	Peso g	Preço
CMQ-150	1580	150	85	580	€ 20,30
CMQ-300	1580	300	85	680	€ 23,30
CMQ-450	1580	450	85	790	€ 26,90
CMQ-600	1580	600	85	890	€ 30,50



Tesouras Corte de Chapa

Tesouras para corte de chapa com retorno e travão. Cabo ergonómico bi-material. Lâminas temperadas aço CrMo. Braços com mola para maior poder de força no corte. Travamento de segurança para armazenamento seguro



nºStock	Tipo	Cabo	Corte aço mm	Corte inox mm	Comp. mm	Preço
491-7N	recta	amarelo	1.8	2,2	190	€ 25,60
493-7N	recta/direit	verde	1.8	2,2	182	€ 25,70
494-7N	recta/esq.	vermelho	1.8	2,2	182	€ 25,70

Lâminas em aço-molibdénio endurecidas por indução HRC60-62.



nºStock	Tipo	Cabo	Corte aço mm	Corte inox mm	Comp. mm	Preço
490	recta	amarelo	1.5	0.9	255	€ 22,20
491	recta/direita	cinza	1.5	0.9	250	€ 22,20
492	recta/esq.	vermelho	1.5	0.9	250	€ 22,20



nºStock	Tipo	Cabo	Corte cobre mm	Corte aço mm	Aço duro mm	Corte inox mm	Comp. mm	Preço
490-W	recta	amarelo	1.8	1.5	1.0	0.9	255	€ 24,00
491-W	recta/dt.	cinza	1.8	1.5	1.0	0.9	250	€ 24,00
492-W	recta/esq.	vermelho	1.8	1.5	1.0	0.9	250	€ 25,00

Lâminas em aço-molibdénio endurecidas por indução HRC60-62.



Série 49...N



Série 49...W

Série 49...W



Tesoura Corte de Chapa Longa

Tesoura longa, recta, para corte de chapa com retorno e travão. Cabo ergonómico bi-material. Lâminas aço CrMo endurecidas por indução, HRC-60-62.

nºStock	Tipo	Cabo	Corte aço mm	Corte inox mm	Preço
495	recto	amarelo	0.94	0.53	€ 23,70

Lâminas em aço-molibdénio endurecidas por indução HRC60-62.



Tesouras Corte de Chapa Offset

Tesouras corte de chapa offset com retorno e travão. Cabo ergonómico bi-material.

nºStock	Tipo	Cabo	Corte aço mm	Corte inox mm	Preço
493	offset/dt.	cinza	1.5	0.9	€ 30,80
494	offset/esq.	vermelho	1.5	0.9	€ 30,80



Cabo em TPR duplo componente



Corta Rebites

Corta rebites industrial, corte a 30º, equipado com parafuso de centrar para maior segurança na utilização.

nºStock	Comp. mm	Comp.	Capacidade	Peso g	Preço
BC-414	350	14"	7mm HRC15 or 4mm HRC40	1000	€ 33,65
BC-418	450	18"	8mm HRC15 or 5mm HRC40	1600	€ 41,50
BC-424	600	24"	10mm HRC15 or 6mm HRC40	2500	€ 53,90
BC-430	750	30"	13mm HRC15 or 7mm HRC40	3500	€ 74,00
BC-436	900	36"	16mm HRC15 or 8mm HRC40	5000	€ 91,25

Lâminas de Substituição

BC-414J	BC414	€ 27,00
BC-418J	BC418	€ 35,00
BC-424J	BC424	€ 43,00
BC-430J	BC430	€ 60,00
BC-436J	BC436	€ 75,00



Armações de Serra

Serrote de aço de qualidade profissional quadro ergonómico em alumínio e pega em borracha macia. Inclui lâmina de serra HSS de 24 dentes de 300 mm / 12". Configurável para corte a 45 ° ou 90 °. Comprimento total 395mm.



nºStock	Descrição	Preço
701-N1	Armação de serra	€ 29,00
702	2 lâminas de serra 24 dentes	€ 8,90

nºStock	Descrição	Preço
701-N	Armação de serra	€ 30,00
702	2 lâminas de serra 24 dentes	€ 8,90

nºStock	Descrição	Preço
701	Armação de serra	€ 27,00
702	2 lâminas de serra 24 dentes	€ 8,90

Mini Armações de Serra

Mini armação de serra de qualidade profissional, quadro em alumínio fundido, forma curva para permitir acesso a espaços confinados, punho ergonómico revestido com borracha. Fornecido com duas lâminas de serra, 6" x 24 dentes e 6¾" x 16 dentes.



nºStock	Comp. mm	Peso g	Qtd.	Preço
705-A	280	193		€ 12,70
705-A-5	63/4" x 16 dentes	19	5pcs (madeira)	€ 6,50
705-5	6" x 24 dentes	19	5pcs (metal)	€ 5,00

Mini Armações de Serra

Mini armação de serra de qualidade profissional com configuração de lâmina de 6 posições. Inclui 3 lâminas de serra de 6".



nºStock	Descrição	Preço
705	Mini armação de serra	€ 9,80
705-5	5 lâminas de serra	€ 5,00



Jogo Punho de Serra (t/ canivete)

Conjunto de serra + lâmina de 24 dentes para cortar metal e lâmina de 10 dentes para cortar madeira ou plástico. Punho ergonómico com mecanismo de bloqueio de posição 135°/180°/225°.

nºStock	Descrição	Preço
703-A	3 peças punho serra	€ 28,20
703-A-10	serra 10 dentes para madeira ou plástico	€ 3,50
703-A-24	serra 24 dentes para metal	€ 4,75



Jogo Punho de Serra

Conjunto de serra + lâmina de 24 dentes para cortar metal e lâmina de 10 dentes para cortar madeira ou plástico. Punho ergonómico com mecanismo de bloqueio de posição.

nºStock	Descrição	Preço
703	3 peças punho serra	€ 18,60
703-10	serra 10 dentes para madeira ou plástico	€ 5,00
703-24	serra 24 dentes para metal	€ 7,00



704 | € 8,50

Suporte para serra em plástico, com punho anti-deslizante, inclui lâmina de serra 12".



700-PRO5 | € 41,00

Jogo de ferramenta de corte, inclui x-acto Teng Tools, armação de serra junior e armação de serra de 12".

Contém	Armações de serra 701 e 705
	X-acto industrial 710



301



X-acto

X-acto com lâmina de 9mm. Com botão de bloqueio e clipe para bolso. (lâminas de substituição disponíveis).

nºStock	Descrição	Corpo	Laminas	mecanismo lock-on/off	Preço
710-A	x-acto	Metálico	1	não	€ 3,40
710-H	x-acto	Plastico	1	sim	€ 1,90
710-F	x-acto	Plástico	2	não	€ 3,40



nºStock	aplicar em 710A-710H-710F	Preço
710-A-10	10 lâminas 9mm	€ 2,70
710-A-100	100 lâminas 9mm	€ 21,80

X-acto

X-acto com lâmina de 18mm. Com botão de bloqueio e clipe para bolso. (lâminas de substituição disponíveis).

nºStock	Descrição	Corpo	Laminas	mecanismo lock-on/off	Preço
710-C	x-acto	Plástico	1	sim	€ 3,40
710-G	x-acto	Plastico	2	sim	€ 6,50



nºStock	aplicar em 710C-710G	Preço
710-F-10	10 lâminas 18mm	€ 3,90
710-F-100	100 lâminas 18mm	€ 33,30



710-S | 16,00

Jogo de 4 x-actos.



X-actos	710A metálico 9mm
	710F plástico 9mm
	710C plástico 18mm
	710G plástico 18mm



X-acto Dobrável (mini)

X-acto dobrável de alumínio com 1 lâmina fixa.
(Lâminas de reposição disponíveis)

nºStock	Descrição	Preço
P-UKF	x-acto	€ 8,90

**X-acto Dobrável**

X-acto dobrável de alumínio com 3 lâminas fixas.
(Lâminas de reposição disponíveis)

nºStock	Descrição	Preço
712	x-acto	€ 20,20

**710 | € 6,70**

X-acto para trabalhos pesados com lâmina retráctil.
Fornecido com 2 lâminas de substituição.

**710N | € 12,80**

X-acto ergonómico para trabalhos pesados, secção revestida com borracha anti-derrapante, lâmina retráctil. Ajuste de lâmina de 3 posições. Compartimento para guardar lâminas. Fornecido com 2 lâminas.

**711 | € 17,90**

X-acto de segurança com cabo plástico bi-material e lâmina retráctil. Para trocar a lâmina pressiona-se o botão junto a mesma, quando acionado a lâmina sai fora, ao acionar o botão que se encontra na parte posterior do x-acto uma das 6 lâminas presentes no compartimento de alojamento de lâminas de substituição é carregada automaticamente. Fornecido com 6 lâminas.



nºStock	QT	aplicar em	Preço
710-10-H	10 lâminas	712-710-710N-711	€ 7,80
710-100-H	100 lâminas	712-710-710N-711	€ 69,30



nºStock	QT mm	aplicar em	Preço
710-U-10	10 lâminas	P-UKF	€ 3,10
710-10	10 lâminas	712-710-710N-711	€ 3,80
710-100	100 lâminas	712-710-710N-711	€ 25,80



Corta Tubos

Uma lâmina dois rolamentos.

nºStock	Tubo Ø mm	Tubo Ø «	Observações	material	Rodizio substituição	Preço
TF-22	3-22	1/8-7/8	para espaços reduzidos	cobre e latão	não	€ 10,80
TF-30	3-32	1/8-1-1/4	c/ rebarbador retráctil	cobre e latão	sim	€ 21,20
TF-76	16-76	1/4-3	heavy duty	cobre, latão aluminio e plásticos	não	€ 103,00



nºStock	Rodizios x 2	Preço
TF-22306-RK	TF22-TF30	€ 4,00
TF-76-RK	TF76	€ 56,20

Corta Tubos

Corta tubos individuais para cortar girando em torno do tubo.



nºStock	Tubo Ø mm	Preço
TFA-10	10	€ 22,20
TFA-12	12	€ 22,60
TFA-15	15	€ 24,10
TFA-22	22	€ 27,60
TFA-0252RK	5 rodizios	€ 19,00

DET-01 | € 12,90

Rebarbador com lâmina giratória. A lâmina HSS é montada na cabeça giratória e adapta-se à forma da peça de trabalho automaticamente. Use para diferentes operações de rebarbação em tubos, orifícios, arestas, etc. Fornecido com 2 lâminas HSS.



DET-02 | € 8,50

Rebarbador com lâmina giratória. A lâmina HSS é montada na cabeça do rebarbador e adapta-se à forma da peça de trabalho automaticamente. Use para diferentes operações de rebarbação em tubos, orifícios, arestas, etc.



nºStock	Laminas Substituição	Preço
DET-01-RK	2 pc	€ 9,40



TFP-01 | € 58,50

Corta os tubos de polietileno PEX ou XLPE e outras tubulações de plástico macio semelhantes, até 42mm de diâmetro.

Corte em ângulo recto e sem rebarbas.

**TFP01RK | € 17,70**

Lâmina de substituição para TFP01.

**TFP-02 | € 60,20**

Corta os tubos de polietileno PEX ou XLPE e plástico macio semelhante

Tubos de 0 até 42mm de diâmetro.

Corte em ângulo reto e sem rebarbas.

**TFP-02RK | € 20,70**

Lâmina de substituição para TFP02.

TF-300 | € 82,90

Corta tubos de corrente. Para cortar tubos de paredes finas (aço inoxidável, cobre, PVC, etc.) até uma espessura de material de 1,5 mm. Travão automático, alavanca de operação uma mão e porca de ajuste. Niquelado. A corrente possui 15 rodas de cort. Comprimento total 10", 780g.

TF-300RK | € 59,00

Corrente de substituição para TF300.

**Rebarbadores de Tubos em Alumínio**

Para rebarbar tubos de cobre, alumínio e latão com cortadores em ambas as extremidades para rebarbação interna e externa.

nºStock	Tubo Ø mm	Corpo em	Preço
DBT-41	3 a 41mm	Plástico	€ 9,60
DBT-35	8 a 35mm	Metal	€ 74,30
DBT-54	10 a 54mm	Metal	€ 91,50

**Tesoura de Electricista**

Tesoura de electricista, lâmina em aço carbono de alta densidade. Cabo ergonómico bi-material.

nºStock	Comprimento mm	Capacidade mm	Corte f. cobre mm	Preço
497	138	42.0	22.0	€ 26,30



DB-028 | € 65,00

Conjunto de brocas de 28 peças, fornecido em caixa de plástico. O ângulo espiral é de 28° e um ângulo de ponto de 118°. Possui um ponto de divisão para melhor precisão posicional. Brocas padrão para uso em aço e ferro fundido.



DB-034 | € 131,00

Conjunto de brocas de 34 peças, fornecido em caixa de plástico. O ângulo espiral é de 28° e um ângulo de ponto de 118°. Possui um ponto de divisão para melhor precisão posicional. Brocas padrão para uso em aço e ferro fundido.



Brocas Rectificadas

Brocas com um ângulo espiral de 28° e um ponto ângulo de 118°. As brocas têm um ponto de divisão para melhor precisão posicional. Brocas padrão para uso em aço e ferro fundido. DIN 338.



nºStock	Medida mm	Espiral mm	Comp. mm	Qtd.	Preço
DBX-010	1.0	12.0	34.0	10	€ 3,30
DBX-015	1.5	18.0	40.0	10	€ 3,69
DBX-020	2.0	24.0	49.0	10	€ 4,09
DBX-025	2.5	30.0	57.0	10	€ 4,54
DBX-030	3.0	33.0	61.0	10	€ 8,01
DBX-033	3.3	36.0	65.0	10	€ 9,42
DBX-035	3.5	39.0	70.0	10	€ 9,42
DBX-040	4.0	43.0	75.0	10	€ 10,22
DBX-042	4.2	43.0	75.0	10	€ 12,92
DBX-045	4.5	47.0	80.0	10	€ 12,92
DBX-050	5.0	52.0	86.0	10	€ 15,27
DBX-055	5.5	57.0	93.0	10	€ 21,02
DBX-060	6.0	57.0	93.0	10	€ 23,37
DBX-065	6.5	63.0	101.0	10	€ 26,30
DBX-068	6.8	69.0	109.0	10	€ 31,35
DBX-070	7.0	69.0	109.0	10	€ 31,35
DBX-075	7.5	69.0	109.0	10	€ 36,52
DBX-080	8.0	75.0	117.0	5	€ 23,60
DBX-085	8.5	75.0	117.0	5	€ 25,48
DBX-090	9.0	81.0	125.0	5	€ 30,06
DBX-095	9.5	81.0	125.0	5	€ 33,10
DBX-100	10.0	87.0	133.0	5	€ 38,75
DBX-105	10.5	87.0	133.0	5	€ 42,27
DBX-110	11.0	94.0	142.0	5	€ 48,96
DBX1-15	11.5	94.0	142.0	5	€ 53,42
DBX-120	12.0	101.0	151.0	5	€ 61,41
DBX-125	12.5	101.0	151.0	5	€ 66,69
DBX-130	13.0	101.0	151.0	5	€ 71,860



TAP-HNDL | € 7,20

Desandador de machos extensível. Para machos de 3 a 12mm.

**DIE-HNDL | € 8,350**

Porta-caçonetes.

**Machos e Caçonetes**

Machos e caçonetes individuais, para reposição dos conjuntos de machos e caçonetes da Teng Tools.

nºStock	Medida mm	Descrição	Preço
TDT-03050	3mm x 0.5mm	Macho	€ 3,15
TDT-04070	4mm x 0.7mm	Macho	€ 3,15
TDT-05080	5mm x 0.8mm	Macho	€ 3,45
TDT-06100	6mm x 1.0mm	Macho	€ 3,45
TDT-08125	8mm x 1.25mm	Macho	€ 3,90
TDT-10150	10mm x 1.5mm	Macho	€ 4,35
TDT-12175	12mm x 1.75mm	Macho	€ 4,60
TDD-03050	3mm x 0.5mm	Caçonete	€ 6,30
TDD-05080	5mm x 0.8mm	Caçonete	€ 6,30
TDD-04070	4mm x 0.7mm	Caçonete	€ 6,30
TDD-06100	6mm x 1.0mm	Caçonete	€ 6,30
TDD-08125	8mm x 1.25mm	Caçonete	€ 6,30
TDD-10150	10mm x 1.5mm	Caçonete	€ 6,30
TDD-12175	12mm x 1.75mm	Caçonete	€ 6,30

**M-140070 | 23,50**

Bucha com quadra de 1/4 "para uso com caçonetes. Comprimento 70mm, diâmetro 35mm.

**Buchas para Machos**

Buchas com quadra de 1/4 "para uso com machos.

nºStock	Quadra	Para Machos: mm	Ø Bucha	Preço
M-140071	1/4	3-8	20	€ 10,90
M-140072	1/4	5-12	25	€ 14,20









Limas de Precisão



nºStock	Tipo	Comp. mm	Preço
TTNF12-01	murça	160	€ 3,20
TTNF12-02	meia cana	160	€ 3,20
TTNF12-03	triangular	160	€ 3,20
TTNF12-04	quadrada	160	€ 3,20
TTNF12-05	redonda	160	€ 3,20
TTNF12-06	plana	160	€ 3,20
TTNF12-07	tipo faca	160	€ 3,20
TTNF12-08	barra	160	€ 3,20
TTNF12-09	cruzada	160	€ 3,20
TTNF12-10	oval	160	€ 3,20
TTNF12-11	ponta de pena	160	€ 3,20
TTNF12-12	ponta de pena redonda	160	€ 3,20

Limas



nºStock	Tipo	Comp. mm	Preço
FLFT-10	 plana	250	€ 10,70
FLHF-10	 murça	250	€ 10,70
FLHR-10	 meia cana	250	€ 11,50
FLRD-10	 redonda	250	€ 8,90
FLTR-10	 triangular	250	€ 10,30
FLSQ-10	 quadrada	250	€ 9,75



Mini Tesouras

Mini tesouras em aço inox temperado, acabamento mate .



nºStock	Comprimento mm	Ponta	Peso g	Preço
SR-1160	160	recta,bico	61	€ 29,00
SR-1180	180	recta,bico	77	€ 33,00
SR-2180	180	recta,redont	69	€ 33,00
SR-3160	160	curva,bico	61	€ 31,00



TC-A06 | € 116,00

Banco de mecânico com altura ajustável de 420 a 500mm.
Peso 6.3kg.



TC-A07 | € 137,00

Estrado 1050 x 500 x 155mm, 8.5kg.



Tapetes

Tapete para joelhos em esponja EVA de 30,5mm de espessura.



nºStock	Medidas mm	Preço
KP-03	480x320	€ 28,20
KP-01	450x210	€ 18,50
KP-02	880x300	€ 46,30

Tinas

Tina magnética, com ímãs revestido a borracha para não danificar superfícies com pintura.
Para colocar parafusos, porcas, pinos, etc...



nºStock	Medidas mm	Preço
580	150x150	€ 15,00
580-S	270x270	€ 47,00
580-A	280x114x65	€ 36,00



nºStock	Medida	Medida mm	Preço
PB-12	12"	300	€ 18,80
PB-16	16"	400	€ 25,20
PB-20	20"	500	€ 40,20

Barras de Força

Com extremidade pontiaguda e em cunha.



nºStock	Comprimento mm	Comprimento	Preço
PB-12-A	300	12"	€ 13,00
PB-18-A	450	18"	€ 19,00
PB-22-A	550	22"	€ 21,60

Pés de Cabra

Pés de cabra reforçados, com cabo Power Thru. 12 ", 18" e 22 ".



nºStock	Comprimento mm	Comprimento	Preço
AT-20512	304	12	€ 18,50
AT-20516	406	16	€ 27,70
AT-20520	508	20	€ 33,70
AT-20524	609	24	€ 44,90

Ferros de Desmonta

Ferramenta para remover peneu da jante.



nºStock	Medida mm	Preço
PF-190	190	€ 9,00
PF-380	380	€ 17,30

Pés de Cabra

Pés de cabra esguio, ideal para uso em espaços confinados. Construção robusta em aço (Aço carbono médio 1045).



nºStock	Ventosas nº	Capacidade Kg	Ventosa Ø mm	Peso g	Preço
SL-01	1	30	118	310	€ 43,40
SL-02	2	60	118	600	€ 55,20
SL-03	3	120	118	900	€ 82,10

Ventosas

Para levantamento de itens com grandes superfícies planas e lisas, como vidro, mármore, etc. As ventosas têm 118 mm de diâmetro. A carga máxima para cada ventosa é mostrado na tabela abaixo.



Chave de Rodas

Chave de rodas extensível com quadra de 1/2", inclui chave de caixa dupla (também disponível individualmente ou em conjunto com extensão). Estende-se de 14" (35cm) a 21" (55cm). Aço-vanádio cromado.



nºStock	Quadra	Medida mm	Peso g	Preço
1202	1/2"	17 x 19	900	€ 21,00
1202-A	1/2"	21 x 22	905	€ 21,70

Chaves de Rodas Combinadas

Chaves de caixa dupla 1/2", impacto para porcas de rodas automóvel.

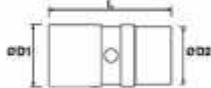

nºStock	Medida mm	D1 mm	D2 mm	L mm	Preço
9291719	17/19	28	28	58	€ 11,00
9292122	21/22	32	32	58	€ 12,20

9203-N1 | € 25,00

Jogo com 2 chaves de caixa dupla impacto de 1/2" e extensão 3".



Acessórios	1/2"	extensão 3" (75mm)
Ch. de caixa	1/2"	17x19mm, 21x22mm

Chaves de Rodas Longas

Chaves de rodas longas com quadra de 1/2", 6 pontos. Em aço-molibdênio cromado com inserções protectoras para uso em jantes de alumínio. Acabamento em preto.

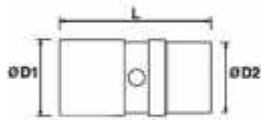

nºStock	Medida mm	L mm	T mm	D1 mm	D2 mm	Peso g	Preço
920517-N	17	85	27	26	32	260	€ 16,50
920519-N	19	85	27	29	32	270	€ 16,50
920521-N	21	85	27	29	32	380	€ 16,80

9203-N | € 47,00

Jogo 3 chaves de rodas longas com quadra de 1/2", 6 pontos, de 17, 19 e 21 mm. Em aço-molibdênio cromado com inserções protectoras para uso em jantes de alumínio. Acabamento em preto.



Chaves Especiais Automóvel

nºStock	Quadra	Medida	Comp. mm	Aplicação	Preço
920242	1/2"	1 5/16"	78.0	chave de rodas	€ 20,00
920248	1/2"	1 1/2"	78.0	juntas esféricas	€ 21,00



920624-N	1/2"	1	78.0	válvula de pressão de óleo	€ 13,10
920627-N	1/2"	1	78.0	injectores	€ 15,30
920628-N	1/2"	1	78.0	injectores diesel	€ 16,50
920629-N	1/2"	1	78.0	válvula de termostato	€ 16,70
920630-N	1/2"	1	78.0	porcas de transmissão	€ 17,00
920632-N	1/2"	1	78.0	porcas de transmissão	€ 17,80
920635-N	1/2"	1	78.0	porcas de transmissão	€ 20,00
920636-N	1/2"	1	78.0	porcas de transmissão	€ 21,00



940641	3/4"	1	58.0	porcas de transmissão	€ 36,00
940258	3/4"	1 1/4"	58.0	juntas esféricas	€ 40,00



120955-C	1/2"	1	100	parafusos de cabeça de motor	€ 8,60
120970-C	1/2"	1	125	parafusos de cabeça de motor	€ 9,50



AT-350	1/2"	1	90.0	sensor de oxigénio	€ 27,70
AT-355	3/8"	1	90.0	sensor de oxigénio	€ 17,20
AT-360	1/2"	1	85.0	quadra de injector	€ 20,20
AT-365	3/8"	1	80.0	quadra de interruptor de vacuo	€ 18,60
AT-370	3/8"	1	74.0	bomba de óleo	€ 15,70
AT-375	1/2"	1	50.0	sensor de ar quente	€ 20,70
AT-380	3/8"	1	30.0	sensor de ar offset	€ 21,30



Chaves de Velas em T

Chaves de velas articuladas, hexagonais com inserção em borracha, em aço-vanádio cromado, acabamento acetinado.

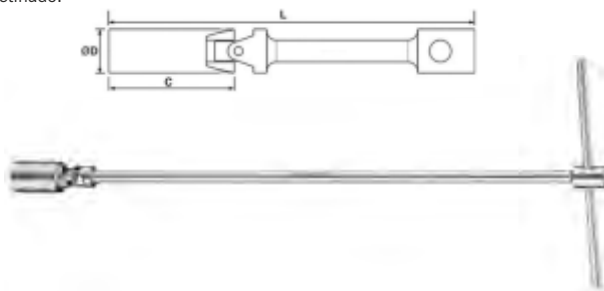

nºStock	Tamanho mm	Inserção borracha	L mm	C mm	D mm	Peso g	Preço
TBUSP-14	14	8	520	60	18.8	380	€ 34,30
TBUSP-16	16	10	520	60	21.8	400	€ 34,50
TBUSP-21	21	14	520	60	27.8	440	€ 36,30

Chaves de Velas

Hexagonais com inserção em borracha, em aço-vanádio cromado, acabamento acetinado.



nºStock	Quadra	Descrição	Largura mm	Inserção borracha	Comprimento mm	Peso g	Preço
M380039-C	3/8"	chave velas 14mm	20.0	8	64	73	
M380040-C	3/8"	chave velas 16mm	21.4	10	64	100	€ 4,00
M380042-C	3/8"	chave velas 18mm	23.5	12	70	130	€ 5,35
M380046-C	3/8"	chave velas 21mm	28.0	14	70	160	€ 5,45

nºStock	Quadra	Descrição	Largura mm	Inserção borracha	Comprimento mm	Peso g	Preço
M380041-C	3/8"	chave velas 16mm articulada	22.0	10	85	117	€ 11,20
M380047-C	3/8"	chave velas 21mm articulada	28.0	14	91	169	€ 12,40

nºStock	Quadra	Descrição	Largura mm	Inserção borracha	Comprimento mm	Peso g	Preço
M120040-C	1/2"	chave velas 16mm	21.4	10	70	165	€ 5,50
M120042-C	1/2"	chave velas 18mm	24.2	12	70	165	€ 7,00
M120046-C	1/2"	chave velas 21mm	28.0	14	70	165	€ 7,30



Alicate p^a Velas

Alicate para velas de ignição, com tenazes revestidas e mola de retorno.

nºStock	Comp. mm	Peso g	Preço
SPBP-20	250	297	€ 18,90

**Limpa Velas**

Limpa velas, para limpar ou rectificar rosca de encaixe de velas.

nºStock	Descrição	Preço
TRC-1012	limpa/rectifica encaixe de vela de ignição 10 x 12mm	€ 13,20
TRC-1418	limpa/rectifica encaixe de vela de ignição 10 x 18mm	€ 15,00

**Apalpa Folgas**

Apalpa folgas em aço laminado temperado com parafuso de aperto.



nºStock	nº Lâminas	Comprimento mm	Preço
FG-13100	13	100	€ 5,80
FG-20100	20	100	€ 7,90
FG-20200	20	200	€ 20,50

TG-MMUNC | € 21,00

Conta fios com 55 lâminas, para medir fio de rosca métrica e UNC.



Lâm	Métricas	
.	0.25, 0.3, 0.35, 0.4, 0.45, 0.5, 0.6, 0.7, 0.75, 0.8, 0.9, 1.0, 1.25, 1.5, 1.75, 2.0, 2.5, 3.0, 3.5, 4.0, 4.5, 5.0, 5.5, 6.0	
	UNC	4, 4 1/2, 5, 5 1/2, 6, 7, 8, 9, 10, 11, 11 1/2, 12, 13, 14, 15, 16, 18, 20, 22, 24, 26, 27, 28, 30, 32, 34, 36, 38, 40, 42



Martelos Batente Anti-Retorno

Cabeça de martelo revestida com borracha e nos modelos PU (poliuretano)

- Função de golpe morto usando esferas de aço para amortecer o choque.
- Faces que são suaves para a peça a trabalhar
- Sem faíscas devido à ausência de metal exposto.



nºStock	Face Ø mm	Peso g	Preço
HMDH-35	35	300	€ 23,70
HMDH-45	45	490	€ 33,60
HMDH-55	55	980	€ 40,00
HMDH-65	65	1365	€ 51,700

nºStock	face mm	Peso. g	Preço
HMDH-50-PU	50	750	€ 52,50
HMDH-60-PU	60	1270	€ 56,40
HMDH-70-PU	70	1500	€ 71,90

Martelos de Chapeiro

Martelos com cabeças em aço. Cabo em nogueira.



nºStock	Tipo	Comp. mm	Peso g	Preço
HMBH-01	Pena / face plana	325	400	€ 28,70
HMBH-02	Pena (redonda) / face plana	325	350	€ 29,00
HMBH-03	Face plana / face quadrada serrilhada	325	400	€ 34,30



Batentes

Batentes, para uso conjunto com martelos de chapeiro.



nºStock	Tipo	Comp. mm	Esp. mm	Altura mm	Peso g	Preço
AT-415	Curved	128	58	40	1.1	€ 35,10
AT-420	Heel	80	60	30	0.9	€ 30,80



AT-170 | € 10,20

Punção paralela para remover pinos de disco de travão.
Comprimento total de 165mm.

**AT-160 | € 13,00**

Ferramenta p/ limpeza citas de travão.
com removedor/instalador de molas de retenção

**Polidor de Cilindro de Travão**

Polidor de cilindro de travão, adequado para cilindros de 20 a 68mm de diâmetro. Ajuste da tensão da mola para dar uma acção de corte positiva. Grão 220.

nºStock	Descrição	Preço
AT-180	Polidor de cilindro de travão	€ 14,20
AT-180-S	pedra polir (x3)	€ 12,80

**AT-330 | € 25,20**

Removedor de pastilhas de travão.

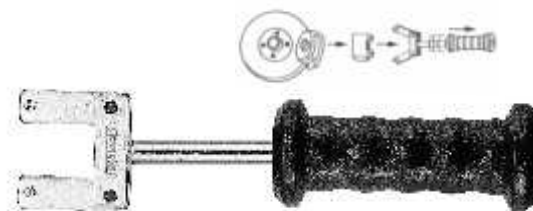
**Polidor de Cilindro de Motor**

Polidor de cilindro de motor ajustável, adequado para cilindros de 50 a 180mm de diâmetro. Ajuste da tensão da mola para dar uma acção corte positiva. Adequado para uso com ferramentas pneumáticas. Grão 280.

nºStock	Descrição	Preço
AT-040	Polidor de cilindro de motor	€ 36,70
AT-040-SM	pedra polir (x3)	€ 14,80

nºStock	Encaixe mm	Abertura até mm	Preço
AT-186	18	38	€ 32,00
AT-191	29	60	€ 79,00
AT-192	40	80	€ 104,00
AT-194	46	100	€ 114,00

nºStock	Encaixe mm	Abertura até mm	Preço
AT-195	16	50	€10,00

Extractores de Rotulas

esferas.

**AT-200 | € 49,00**

Compressor de mola helicoidal com ganchos de segurança.
Simples de usar. Capacidade 250mm.

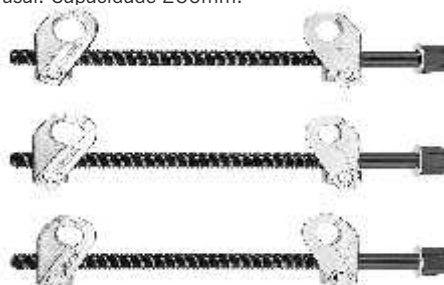
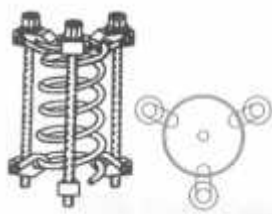

Chave de Filtro de Óleo

Chave de filtro de óleo totalmente ajustável, chave de cinta para serviços pesados para uma ampla variedade de tarefas de garagem e oficina. Com cinta reforçada antiderrapante. Capacidade 160mm. Comprimento da ferramenta 230mm.



nºStock	Descrição	Preço
9123	Chave filtro de óleo	€ 35,40
9123-RK	kit reparação	€ 11,20

Chaves de Filtro de Óleo

9110. Ferramenta de remoção do filtro de óleo estilo chave de cinta, cinta de nylon, encaixe para quadra 1/2". Capacidade 130mm.

9120. Ferramenta de remoção do filtro de óleo estilo chave de corrente, corrente de aço, encaixe para quadra 1/2". Capacidade 120mm.



nºStock	Descrição	Preço
9110	Chave filtro de óleo	€ 8,40
9110-RK-1	kit reparação	€ 4,00
9120	Chave filtro de óleo	€ 9,90
9120-RK-1	kit reparação	€ 7,10

9120-HD | € 28,00

Ferramenta de remoção de filtro de óleo do tipo corrente com uma resistência à tração máxima de 1850kgf e uma capacidade de 150mm. encaixe para quadra de 1/2".



9124 | € 44,20

Chave de corrente para montagem e desmontagem de tubos etc. Para tubos até 4".



nºStock	Medida	Preço
DP-0810	8mm hex x 10mm hex	€ 7,00
DP-0812	8mm quad x quadra 3/8"	€ 7,00
DP-1012	5/16" hex x 3/8" hex	€ 7,00
DP-1112	11mm quad x 12mm hex	€ 7,00
DP-1314	13mm quad x 14mm hex	€ 7,00
DP-1716	17mm hex x 1/2" hex	€ 7,00

Bujões de Óleo

Bujões de óleo com diferentes formas e tamanhos, adequados para drenagem em motores e caixas de velocidades.



AT-020 | € 35,20

Compressor de anel de pistão com 4 cintas de aperto adequadas para diâmetros de cilindro de 90 a 175mm. Roquete bloqueio automático. O rebordo anti-fricção oferece uma acção suave e precisa.



AT-005 | € 13,50

Testador de fugas para cilindros de motor, encaixe de vela de ignição de 14 / 18mm e linha de ar fêmea BSP de 1/4". Para testar sem retirar a cabeça do motor. Comprimento total 160mm.



409 | € 27,70

Alicate de fixação para filtros de óleo, capacidade 53 a 118mm. Bloqueio automático e parafuso de ajuste. Aço-vanádio cromado.



Blocos Magnéticos

Blocos magnéticos usados para soldar chapas, tubos, etc., a 90° ou 45°. Pode ser usado em superfícies de trabalho redondas e planas.



319



nºStock	Comp. mm	Altura mm	Força N	Preço
MH-75	120	82	27	€ 9,50
MH-90	160	100	27	€ 17,30



MD-503-N | € 12,90

Chave flexível para aperto de porcas de 6 e 7mm, reversível, cabo ergonómico bi-material.



MD-503-NA | € 10,30

Chave flexível para aperto de porcas de 7mm, cabo ergonómico bi-material.



MD-503-ND | € 10,60

Chave flexível para aperto de porcas de 8mm, cabo ergonómico bi-material.



Ferramenta de Remoção e Raspagem

Ferramenta individual, para remoção e raspagem.



nºStock	Ponta	Preço
MD-HS	90°	€ 7,70
MD-HL	curva em S	€ 7,10
MD-AR	recta / redonda	€ 7,10
MD-ASQ	recta / quadrada	€ 7,50
MD-SCR	pá 22mm	€ 12,20

Ferramenta para Inscrição e Limpeza

Ferramenta individual, para inscrição e limpeza com cabo ergonómico bi-material.



nºStock	Ponta	Preço
MD-A-180	recta	€ 4,30
MD-P-90	90°	€ 4,40
MD-P-35	35°	€ 4,40
MD-P-125	gancho	€ 4,40



Ferramenta de Remoção de Paineis

Ferramenta individual, para remoção.

nºStock	Ponta	Preço
MD-P-06	em V tamanho S	€ 7,50
MR-P-95	em V tamanho L	€ 11,40
MD-R-06	em U tamanho S	€ 8,00
MD-R-08	em U tamanho L	€ 10,50

**TJ-149 | € 15,50**

Jogo de ferramenta para detalhes e inscrições, composto por 4 riscadores com ponta, recta, em gancho, perpendicular e a 45°. Fornecido em caixa plástica com fecho.



nºStock	Lâmina mm	Comp. mm	Peso g	Preço
WCC-06	6	276	157	€ 9,50
WCC-08	8	276	159	€ 9,50
WCC-10	10	276	171	€ 9,50
WCC12	12	276	183	€ 9,50
WCC-14	14	276	179	€ 9,50
WCC-16	16	276	195	€ 9,50
WCC-18	18	276	200	€ 9,80
WCC-20	20	276	212	€ 10,20
WCC-22	22	276	224	€ 10,20
WCC-25	25	281	229	€ 10,20
WCC-32	32	291	289	€ 11,50
WCC-38	38	305	340	€ 12,10

WC-S04-L | € 37,20 Inclui formões de 6, 12, 18 e 25mm.**WC-S04-S | € 37,20** Inclui formões de 10, 16, 18 e 20mm.Formões, rectificados e anti-corrosão.
Punhos macios resistentes ao impacto com batente.

Grampos Plásticos

Grampos plásticos para tubos e mangueiras.



nºStock	Para tubos: Ø	Preço
AT-080	1/4" - 3/4"	€ 9,95
AT-085	1/4" - 1 1/4"	€ 11,00
AT-090	3/4" - 2 1/4"	€ 14,70

Sondas com Garras

Sondas com garras. Com botão para expandir e contrair. Excelente para alcançar pequenos itens perdidos em áreas ocultas. Comprimento total 600mm.

AT135M com garras magnéticas.



nºStock	Descrição	Comp. mm	Preço
AT-135	sonda com garras	600	€ 16,50
AT-135M	sonda com garras magnéticas	600	€ 28,50



SE-05 | € 14,00

Extractores de parafusos, 5 extractores de parafusos fornecidos estojo de plástico. Medidas: 7/64", 9/64", 5/32", 1/4", 19/64".



TJ-SE-05S | € 18,80

Conjunto com 5 extractores para extracção rápida e fácil de parafusos, tubos e pernos. Haste quadrada endurecida HRC 50-52. Tamanhos para furos 3, 4, 5, 7 e 9mm. Fornecido em caixa plástica com fecho de pressão. Para rosca direita ou esquerda.



nºStock	Para furos Ø	Peso g	Preço
SEL-01S	3mm (1/8")	13	€ 3,10
SEL-02S	4mm (3/16")	22	€ 3,50
SEL-03S	5mm (15/64")	36	€ 4,70
SEL-04S	7mm (5/16")	52	€ 5,50
SEL-05S	9mm (3/8")	148	€ 6,00

nºStock	Para furos Ø	Peso g	Preço
SE-141	T-1 (1/4")	10	€ 2,60
SE-142	T-2 (1/4")	11	€ 2,60
SE-143	T-3 (1/4")	12	€ 2,60





nºStock	Quadra	Medida mm	Preço
ST-12506-C	1/2"	6	€ 15,00
ST-12508-C	1/2"	8	€ 15,00
ST-12510-C	1/2"	10	€ 15,50
ST-12512-C	1/2"	12	€ 15,50

NS-02 | € 30,70

Conjunto com 2 extractores de porcas, para porcas de 5 a 20mm e porcas de 14 a 27mm.

**Extractores de Pernos**

Extractores de pernos reversíveis com quadra 1/2" e sextavada exterior.

**2300 | € 30,70**

Extractor de pernos excêntrico.

**Extractores de Porcas de 3/8" e de 1/2"**

Extractores de porcas para remover cabeças ou porcas de parafusos arredondadas ou danificadas.

nºStock	Medida mm	Medida	L mm	T mm	D1 mm	D2 mm	Peso g	Preço
ST-38306	6	1/4"	27.0	11.0	15.9	9.9	21	€ 23,20
ST-38308	8	5/16"	27.0	11.0	15.9	12.0	23	€ 27,30
ST-38112	-	3/8"	27.0	11.0	15.9	14.2	22	€ 28,80
ST-38310	10	-	27.0	11.0	19.0	15.3	33	€ 23,20
ST-38311	11	7/16"	27.0	11.0	19.0	15.6	33	€ 23,20
ST-38312	12	-	27.0	11.0	19.0	17.4	33	€ 24,20
ST-38116	-	1/2"	27.0	11.0	19.0	17.7	34	€ 25,20
ST-38313	13	-	27.0	11.0	19.0	18.7	35	€ 26,00
ST-38314	14	9/16"	27.0	11.0	22.2	20.7	50	€ 27,30
ST-38316	16	5/8"	27.0	11.0	22.2	22.1	50	€ 27,70
ST-38317	17	-	27.0	11.0	25.4	24.8	74	€ 28,20
ST-38122	-	11/16"	27.0	11.0	25.4	24.8	74	€ 28,50



nºStock	Medida mm	Medida	L mm	T mm	D1 mm	D2 mm	Peso g	Preço
ST-12319	19	3/4"	44.5	11.0	27.0	26.6	167	€ 39,50
ST-12321	21	13/16"	44.5	12.5	32.0	28.0	199	€ 41,50
ST-12322	22	7/8"	44.5	12.5	35.0	30.7	210	€ 43,90
ST-12324	24	15/16"	44.5	12.5	36.0	32.4	210	€ 44,20
ST-12325	25	1"	44.5	12.5	36.0	33.4	214	€ 45,70



Extractores Três/Duas Pernas

Extractores de braço triplo que pode ser facilmente convertido em extractor de duas pernas. Com pernas reversíveis para aderência interna / externa.



nºStock	Alcance mm	Amplitude mm	Peso g	Preço
SPA-11	100	50-100	1008	€ 47,40
SPA-22	170	60-150	2600	€ 79,50

Extractores Universais de 2 Pernas e 3 Pernas

Extractores de duas pernas simples de usar para remoção rápida de polias, rodas e rolamentos. Com pernas reversíveis para uso interno ou externo.



nºStock	a1 mm	a2 mm	b mm	Rosca	Alcance mm	c mm	d mm	e mm	Peso g	Preço
SP-1410	90	133	100	M14 x 1.5	140	17	12	3.4	1.1	€ 87,30
SP-1810	130	170	100	M14 x 1.5	140	17	12	3.4	1.3	€ 92,50
SP-2215	160	209	150	M20 x 2.0	210	22	20	3.8	3.2	€ 150,20
SP-2615	200	256	150	M20 x 2.0	210	22	20	3.8	3.6	€ 172,00
SP-3320	250	325	200	M26 x 2.0	280	27	27	6.2	7.8	€ 296,00

nºStock	a1 mm	a2 mm	b mm	Rosca	Alcance mm	c mm	d mm	e mm	Peso g	Preço
SP-31410	90	140	100	M14 x 1.5	140	17	12	3.4	1.4	€ 136,50
SP-31810	130	180	100	M14 x 1.5	140	17	12	3.4	1.6	€ 145,00
SP-32215	160	220	150	M20 x 2.0	210	22	20	3.8	3.5	€ 211,00
SP-32615	205	260	150	M20 x 2.0	210	22	20	3.8	4.2	€ 215,00
SP-33320	252	330	200	M26 x 2.0	280	27	27	6.2	8.8	€ 316,00



Extractores Universais de 2 Pernas e 3 Pernas- Fixação Rápida

Extractores de duas pernas simples de usar para remoção rápida de polias, rodas e rolamentos. Com pernas reversíveis para uso interno ou externo. Pernas com sistema de fixação rápida.

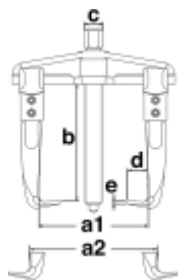

nºStock	a1 mm	a2 mm	b mm	Rosca	Alcance mm	c mm	d mm	e mm	Peso g	Preço
SP-1410Q	90	130	100	M14 x 1.5	140	17	12	3.4	1.1	€ 113,00
SP-1810Q	130	170	100	M14 x 1.5	140	17	12	3.4	1.2	€ 120,60
SP-2215Q	158	209	150	M20 x 2.0	210	22	20	3.8	3.0	€ 182,20
SP-2615Q	200	256	150	M20 x 2.0	210	22	20	3.8	3.4	€ 205,50
SP-3320Q	250	325	205	M26 x 2.0	280	27	27	6.2	7.0	€ 289,00

nºStock	a1 mm	a2 mm	b mm	Rosca	Alcance mm	c mm	d mm	e mm	Peso g	Preço
SP-31410Q	90	130	100	M14 x 1.5	140	17	12	3.4	1.5	€ 159,10
SP-31810Q	130	170	100	M14 x 1.5	140	17	12	3.4	1.6	€ 166,00
SP-32215Q	160	210	150	M20 x 2.0	210	22	20	3.8	3.9	€ 228,00
SP-32615Q	205	260	150	M20 x 2.0	210	22	20	3.8	4.2	€ 285,00
SP-33320Q	252	330	200	M26 x 2.0	280	27	27	6.2	8.6	€ 359,00

Extractores de Engrenagens

Extractores de braço triplo que pode ser facilmente convertido em extractor de duas pernas.

nºStock	Alcance mm	Amplitude mm	Peso g	Preço
SP-11	89	76 - 102	1200	€ 77,50
SP-22	137	75 - 175	2700	€ 154,00



CP-50 | € 25,80

Alicate de terminais de qualidade profissional e descascador de fios, adequado para cravar terminais isolados de 0,75 a 6mm, terminais não isolados de 1,5 a 6mm. Corte de M2 a M5. Decapagem de 0,75 a 6mm.



CP-51 | € 20,80

Alicate de terminais de qualidade profissional e descascador de fios, adequado para cravar terminais isolados de 0,75 a 6mm, terminais não isolados de 0,5 a 2,5 mm (tipo push on), corte de M2 a M5, decapagem de 0,75 a 6mm.



CP-52 | € 68,00

Alicate de terminais, intercambiável com mecanismo de bloqueio automático para garantir uma acção de cravagem consistente e correta. Adequado para cravar rolos e terminais, conectores isolados e não isolados. Capacidade terminais isolados de 1,5 a 6mm² e terminais não isolados de 1,5 a 2,5 mm² e conectores. Corte M2 a M5. Comprimento total 225mm.



CP-58 | € 50,00

Alicate de terminais de precisão. Com cabo ergonómico bi-material. Adequado para terminais isolados vermelhos, azuis e amarelos. Capacidade 0,75 a 6,0 mm, 22-10 AWG. Comprimento total 250mm, peso 560g.



CP-60 | € 33,40

Alicate de terminais automático com função para descarnar e cortar fio. Capacidade de descarnar fio de 0,13 e 8,0 mm². Cravar terminais isolados e não isolados de 0,5 a 6,0 mm. Com mola de retorno e cabo bi-material. Comprimento total 210mm, peso 342g.



CP-53 | € 21,20

Alicate descarnador profissional, para cravar terminais, descarna e corte de fio. Com mola de retorno e travão. Capacidade 0.8, 1.0, 1.3, 1.6, 2.0, 2.6, 3.2mm, 20-8 AWG. Capacidade de corte 1.0mm cabo de cobre. Comprimento total 180mm, peso 140g.

**CP-55 | € 27,20**

Descarnador de fio automático. Com uma lâmina SK5 endurecida para maior rapidez e precisão. Para descarnar fio 24-10AWG ou fio de 0,2 a 6mm². Corta fios até 2 mm de diâmetro. Comprimento total 190mm, 130g.

**CT-G01 | € 34,70**

Pistola de abraçadeiras. Ideal para operações repetidas, para trabalhar com abraçadeiras de plástico de 2,2 a 4,8 mm de largura. Com tensão de aperto ajustável e corte automático. Peso 320g.



Fios de Segurança

Fio de segurança para prender ferramentas ao trabalhar em altura.



nºStock	Descrição	Comp. mm	Cap. mm	Preço
SSH-01	fio espiral, gancho com mola	430 - 1600	3.0	€ 20,50
SSH-02	elástico nylon, gancho com mola	750 - 1350	3.0	€ 22,00
SSH-03	elástico nylon, mosquetão	800 - 1350	4.5	€ 23,00
SSH-04	elástico nylon, mosquetão + fio	800 - 1450	600	€ 22,50

583-M | € 13,00

Pulseira ajustável de 340 mm de comprimento com disco magnético, ideal para parafusos, pregos, etc.



SD-501 | € 6,00

Apanhador magnético telescópico, a capacidade do magneto é de 200g, extensão de 55cm.



585-MP | € 18,00

Caneta telescópica magnética com riscador.



581-TMP | € 24,00

Apanhador magnético telescópico, a capacidade do magneto é de 4500g, extensão de 85cm.



582-MI | € 24,70

Ferramenta de inspeção telescópica 3 em 1, com espelho, riscador e apanhador magnético.



581-TMG | € 22,50

Lupa telescópica, com cabeça ajustável, extensão de 85cm.

**581-TMI | € 21,70**

Espelho telescópico com 57mm de diâmetro, cabeça ajustável, extensão de 85cm.

**9850 | € 11,80**

Busca pólos auto 6-24 volts DC com sonda de aço e tampa de rosca, cabo de 830 mm com clipe jacaré. Simples de usar. Lâmpada 24V 5 Watt.

**FC-01 | € 55,00**

Capa protectora com fita magnética, comprimento total 40cm x 107cm. Frente em PVC resistente, cor vermelho.

**AT-505 | € 23**

Bomba de lubrificação, Capacidade 120cc.

**AT-500 | € 43,90**

Bomba de lubrificação, para uso com cartuchos de massa 400g. Fornecido com tubo e ponteira. Rosca G (R) 1/8". Capacidade 500cc.



587-M | € 13,50

Lâmpada LED de 3 diodos, flexível com base magnética. Requer pilhas tipo LR44 (x3).



Comprimento Total	mm	370
Diâmetro	mm	25
Fluxo Luminoso	lumen	76.5
Peso	g	67

587-H | € 61,50

Lupa iluminada, com 14 leds montados no aro. Requer pilhas tipo 2 AAA (não incluídas).



Resolução	x	3
Diâmetro	mm	100
Fluxo Luminoso	lumen	72

586 | € 53,80

Lanterna flexível com base magnética. Ideal para uso em espaços confinados e para recuperar itens em locais de difícil acesso. Requer 2 pilhas AA (não incluídas).



Comprimento Total	mm	595
Diâmetro	mm	10
Força Magnética	g	750

587-S | € 57,00

Lanterna luca de 14 leds montados em forma de anel. Requer 2 pilhas AAA (não incluídas).



586-A | € 32,00

Lanterna de cabeça LED, com modo intermitente. Requer 3 pilhas AA, não incluídas.



Espessura	mm	50
Altura	mm	50
Comprimento	mm	55
Fluxo Luminoso	lm	250
Peso	g	110

586-C | € 27,50

Lanterna de cabeça LED, com duas posições de luminosidade. Requer 3 pilhas AAA, não incluídas.



Espessura	mm	50
Altura	mm	50
Comprimento	mm	55
Fluxo Luminoso	lm	250
Peso	g	110



581-N1 | € 31,70

Lanterna LED com corpo em alumínio à prova de choque e resistente à água IPX6. Requer 2 pilhas tipo AAA não incluídas.

Comprimento Total	mm	132
Diâmetro	mm	23
Lumens		200
Foco ajustável		Sim
Alcance	mt	105
Clip bolso		Sim

**582-N1 | € 41,00**

Lanterna LED com corpo em alumínio à prova de choque e resistente à água IPX6. Luz indicadora de bateria fraca. Requer 3 pilhas tipo AAA não incluídas.

Comprimento Total	mm	138
Diâmetro	mm	40
Lumens		750
Foco ajustável		Sim
Alcance	mt	178
Clip bolso		Não

**583-N1 | € 53,90**

Lanterna LED com corpo em alumínio à prova de choque e resistente à água IPX6. Luz indicadora de bateria fraca. Requer 6 pilhas tipo AAA não incluídas.

Comprimento Total	mm	205
Diâmetro	mm	40
Lumens		1100
Foco ajustável		Sim
Alcance	mt	239
Clip bolso		Não

**584 | € 18,00**

Lanterna LED 130mm. 2 pilhas tipo AAA. Pilhas não incluídas. c/clip

**585 | € 23,60**

Lanterna LED com corpo em latão cromado acetinado. 25-30 lúmen. 2 pilhas tipo AAA oferece até 5.5 horas de uso médio. Pilhas não incluídas.



Martelos de Carpinteiro

Martelos de carpinteiro 16oz com cabo em aço e punho ergonómico em borracha. Com furação para fio de segurança.



nºStock	Cabeça oz	Peso. g	Cabeça Ø mm	Comp. mm	Preço
HMCH-08A	8	394	21.6	290	€ 18,20
HMCH-13A	13	552	27.0	335	€ 20,50
HMCH-16A	16	700	27.0	312	€ 21,70
HMCH-20A	20	765	30.0	340	€ 24,40

Martelo de Carpinteiro - Anti-Vibração

Martelo de carpinteiro forjado numa única peça, com punho absorvente de choque para reduzir vibração ao golpear. Com furação para fio de segurança.



nºStock	Cabeça oz	Peso. g	Cabeça Ø mm	Comp. mm	Preço
HMCH-M16	16	723	29	333	€ 43,20

Martelo de Carpinteiro - Cabo Fibra

Martelo de carpinteiro com cabo de fibra, punho ergonómico. Com furação para fio de segurança.



nºStock	Cabeça oz	Peso. g	Cabeça Ø mm	Comp. mm	Preço
HMCH-C16	16	686	28	327	€ 22,50

Martelo de Carpinteiro - Magnético

Martelo de carpinteiro magnético, cabo em aço com punho ergonómico em borracha. Com furação para fio de segurança.



nºStock	Cabeça oz	Peso. g	Cabeça Ø mm	Comp. mm	Preço
HMCH-16M	16	678	27.5	341	€ 24,80

Marreta

Marreta, cabo em aço com punho ergonómico em borracha. Com furação para fio de segurança.



nºStock	Cabeça oz	Peso. g	Cabeça Ø mm	Comp. mm	Preço
HMS-1250	1,25	1,609	43	296	€ 36,50

Martelos de Bola

Martelos de bola com cabo em fibra de vidro.

nºStock	Cabeça oz	Peso. g	Cabeça Ø mm	Comp. mm	Preço
HMBP-12	12	550	28	280	€ 16,50
HMBP-16	16	600	30	320	€ 19,20
HMBP-24	24	1040	35	380	€ 27,00
HMBP-32	32	1280	39	380	€ 28,20



Martelos de Pena

Martelos de pena com cabo em fibra de vidro.

nºStock	Cabeça oz	Peso. g	Comp. mm	Preço
HMEG-300	300	420	300	€ 15,20
HMEG-500	500	650	320	€ 18,50
HMEG-800	800	1	350	€ 23,60



Martelo de Pedreiro

Martelo de pedreiro, cabo em aço com punho ergonómico em borracha. Com furação para fio de segurança.

nºStock	Cabeça oz	Peso. g	Cabeça Ø mm	Comp. mm	Preço
HMBH-16	16	733	23	291	€ 25,00



Martelo Batentes Macios

Martelo com batentes de borracha e nylon, cabo em aço com punho ergonómico em borracha. Com furação para fio de segurança.

nºStock	Peso. g	Comp. mm	Preço
HMSF	670	320	€ 27,70
HMSF-RK	jogo de batentes		€ 10,00



Bata c/ precisão
Leve mas com desempenho
Heavy Duty



Cabeça de bola
modele o metal à sua
maneira



Óculos de Protecção SG-9

Braços retos
Vidros coloridos c/ proteção contra luz solar/luzes fortes.
Óculos de trabalho leves e confortáveis proporcionam proteção elegante.
Resistente a impactos com alta clareza óptica.
Em conformidade com EN166, AS/NZS1067



nºStock	Lente	Preço
SG-960	Neutra	€ 6,20
SG-960-G	Cinza	€ 6,20
SG-960-Y	Amarela	€ 6,20
SG-960-A	Neutra	€ 5,40

Óculos de Protecção SG-7

Design mais elegante.
Lentes opticamente neutras com resistência anti-embaciante e anti-arranhões (HC/AF).
Ponte nasal macia e peças laterais para um ajuste mais confortável.
Lentes transparentes de policarbonato.
Moldado para proporcionar uma ampla visão panorâmica e proteção lateral integrada.
De acordo com EN166 cl.1FT



nºStock	Lente	Preço
SG-713	Neutra	€ 9,00
SG-713-G	Cinza	€ 12,10

Óculos de Protecção PSG

Braços retos
Vidros coloridos c/ proteção contra luz solar/luzes fortes.
Óculos de trabalho leves e confortáveis proporcionam proteção elegante.
Resistente a impactos com alta clareza óptica.
Em conformidade com EN166, AS/NZS1067



nºStock	Lente	Preço
PSG-01	Cinza	€ 20,30
PSG-02	Cinza	€ 20,30
PSG-03	Espelhada	€ 22,60



PCX-05 | € 29,50

Conjunto de 5 peças, inclui cinzel plano de 18 x 150mm, punção de centro de 5 x 150 mm e três punções paralelas de 3, 4 e 5mm. Fornecido em suporte plástico.



nºStock	Diâmetro mm	Comp. mm	Preço
PP-03	3	150	€ 6,30
PP-04	4	150	€ 6,30
PP-05	5	150	€ 6,30
PP-06	6	150	€ 6,30
PP-07	7	150	€ 7,70
PP-08	8	150	€ 7,70

Punções Paralelos

nºStock	Altura mm	Comp. mm	Peso g	Preço
PCC-AP	120	56	45	€ 3,70

PPS-06 | € 29,00

Conjunto de 6 punções paralelas 150mm 3, 4, 5, 6 e 7mm de diâmetro, em aço endurecido HCR52 +/-2. Fornecido em suporte plástico.



nºStock	Lâmina mm	Comp. mm	Preço
CC-150-F	18	150	€ 11,70
CC-200-F	25	200	€ 18,50
CC-250-F	25	250	€ 19,50
CC-240-F	26	240	€ 22,50

Cinzeis Planos

nºStock	Diâmetro mm	Comp. mm	Preço
CP-04	4	150	€ 6,70
CP-05	5	150	€ 6,70
CP-08	8	150	€ 7,50

Punções de Bico**Proteção para Cinzeis Planos.**

Para cinzeis planos de 200, 240 ou 250 mm.

**SCP-01 | € 22,50**

Punção de centro automática. Diâmetro da ponta de 1 mm, comprimento total 135 mm.

**SCR-01 | € 14,50**

Riscador, cabo serrilhado com clip de bolso.

**SCR-02 | € 5,80**

Riscador, ponta de aço endurecido (qualidade K20 de carboneto de tungstênio), com clip de bolso.



HR-12 | € 49,00

Alicate de rebitar manual para uso profissional. Fornecido com quatro bocais intercambiáveis (para rebites 2,4, 3,2, 4,0 e 4,8 mm) e punhos ergonómicos em borracha para melhor aderência.



Alumínio mm	Aço mm	Aço inox mm	Comp. mm	Peso g
2.4/3.2/4.0/4.8	2.4/3.2/4.0/4.8	2.4/3.2/4.0	250	560

HR-14 | € 30,80

Alicate de rebitar manual para trabalhos pesados. Corpo em aço temperado punhos ergonómicos em PVC.



Alumínio mm	Aço mm	Aço inox mm	Comp. mm	Peso g
2.4,3.0/3.2	2.4/3.0/3.2		270	627

HR-30-R | € 62,00

Alicate de rebitar manual para uso profissional. Fornecido com quatro bocais intercambiáveis (para rebites 2,4, 3,2, 4,0 e 4,8 mm) e punhos ergonómicos em borracha para melhor aderência.



Alumínio mm	Aço mm	Aço inox mm	Comp. mm	Peso g
2.4/3.0/3.2/4.0/4.8	2.4/3.0/3.2/4.0/4.8	2.4/3.0/3.2/4.0/4.8	270	560

HR-01 | € 61,00

Alicate de rebitar manual para trabalhos pesados. Corpo em aço temperado punhos ergonómicos em PVC.



Alumínio mm	Aço mm	Aço inox mm	Comp. mm	Peso g
2.4/3.2/4.0/4.8	2.4/3.2/4.0/4.8	2.4/3.2/4.0	250	560

HR-360-R | € 84,20

Alicate de rebitar manual para uso profissional. O nariz é ajustável entre duas posições para rebitar verticalmente ou horizontalmente. Fornecido com quatro bocais.



Alumínio mm	Aço mm	Aço inox mm	Comp. mm	Peso g
2.4/3.0/3.2/4.0/4.8/5.0	2.4/3.0/3.2/4.0	2.4/3.0/3.2	295	712



HR-LT-01 | € 212,00

Alicate de rebitar manual para uso profissional em aplicações industriais e de construção. O design fornece uma grande força de rebitação e é adequado para uso em áreas de difícil acesso. Com 5 bocais para diâmetros de rebites de 3.2, 4.0, 4.8, 6.0 e 6.4 mm.

**HR-LR-01 | € 188,00**

Alicate de rebitar manual para uso profissional em aplicações industriais e de construção. Os dois apertos de mão oferecem uma grande capacidade de rebitação. Um recipiente de plástico recolhe todos os mandris, com 5 bocais para diâmetro de rebites de 3.2, 4.0, 4.8, 6.0 e 6.4mm.

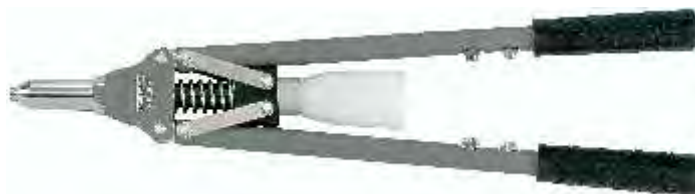
**HN-02 | € 119,30**

Alicate de rebitar para rebites tipo porca, com bloqueio, sistema de troca rápida, mandril roscado.



Capacidade rebites tipo porca	Comp. mm	Peso g
M3 x 0.5, M4 x 0.7, M5 x 0.8, M6 x 1.0	250	10

HR-LN-65-N | € 542,00

Alicate de rebitar para rebites tipo porca, para uso profissional em aplicações industriais e de construção. Os dois apertos de mão oferecem uma grande capacidade de rebitação. Tem uma haste de accionamento rápido para carregamento e descarregamento de mandris. Inclui mandris para M5, M6, M8 e M10.

Capacidade rebites tipo porca	Comp. mm	Peso g
M5, M6, M8, M10	530	1800



AR-WM38 3/8" | € 232,00

AR-WM12 1/2" | € 255,00

AR-WM34 3/4" | € 535,00

Chave de impacto reversível, robusta e potente, para aplicações em oficinas. Ação de alto torque com três posições de aperto. Carcaça em alumínio leve, mas resistente. Mecanismo de martelo duplo para maior torque, maior fiabilidade e vibração reduzida. Botão de avançar / retroceder para operação com uma mão. Cabo ergonómico para melhor aderência e isolamento de vibração e ar frio.



Quadra		3/8"
Parafuso (capacidade)	mm	M13
Velocidade	rpm	9000
Torque Max (3 posições)	Nm	115/285/465
Torque Max (3 posições)	ft-lb	85/210/342
Torque Max (inversão)	Nm	490
Torque Max (inversão)	ft-lb	361
Mecanismo de Martelo	tipo	duplo
Ruido *	dB	95.4
Vibração **	m/s ²	4.96
Mangueira (tamanho min.)	pol.	3/8"
Encaixe	pol.	1/4"
Consumo 100%	l/min	105
Consumo 100%	cfm	3.7
Consumo 15%	l/min	16
Consumo 15%	cfm	0.6
Comprimento	mm	159.4
Peso	kg	1.5

Quadra		1/2"
Parafuso (capacidade)	mm	M16
Velocidade	rpm	6.800
Torque Max (3 posições)	Nm	385/530/930
Torque Max (3 posições)	ft-lb	285/390/685
Torque Max (inversão)	Nm	950
Torque Max (inversão)	ft-lb	700
Mecanismo de Martelo	tipo	duplo
Ruido *	dB	92.5
Vibração **	m/s ²	22,45
Mangueira (tamanho min.)	pol.	3/8"
Encaixe	pol.	1/4"
Consumo 100%	l/min	162
Consumo 100%	cfm	5.3
Consumo 15%	l/min	24.3
Consumo 15%	cfm	0.8
Comprimento	mm	183,1
Peso	kg	2.5

Quadra		3/4"
Parafuso (capacidade)	mm	M32
Velocidade	rpm	5000
Torque Max (3 posições)	Nm	1084/1300/1790
Torque Max (3 posições)	ft-lb	800/960/1320
Torque Max (inversão)	Nm	1,83
Torque Max (inversão)	ft-lb	1,349
Mecanismo de Martelo	tipo	duplo
Ruido *	dB	95.1
Vibração **	m/s ²	11.88
Mangueira (tamanho min.)	pol.	1/2"
Encaixe	pol.	3/8"
Consumo 100%	l/min	181
Consumo 100%	cfm	6.4
Consumo 15%	l/min	27.2
Consumo 15%	cfm	1.0
Comprimento	mm	218.8
Peso	kg	3.9



AR-WC38 3/8" | € 236,00

AR-WC12 1/2" | € 262,00

AR-WC34 3/4" | € 575,00

Chave de impacto reversível, robusta e potente, para aplicações em oficinas. Ação de alto torque com três posições de aperto. Carcaça em material, compósito ultra leve. Mecanismo de martelo duplo para maior torque, maior fiabilidade e vibração reduzida. Botão de avançar / retroceder para operação com uma mão. Cabo ergonómico para melhor aderência e isolamento de vibração e ar frio.

Quadra		3/8"
Parafuso (capacidade)	mm	M13
Velocidade	rpm	9000
Torque Max (3 posições)	Nm	163/244/450
Torque Max (3 posições)	ft-lb	120/180/331
Torque Max (inversão)	Nm	470
Torque Max (inversão)	ft-lb	346
Mecanismo de Martelo	tipo	duplo
Ruido *	dB	94.0
Vibração **	m/s ²	3.80
Mangueira (tamanho min.)	pol.	3/8"
Encaixe	pol.	1/4"
Consumo 100%	l/min	128
Consumo 100%	cfm	4.5
Consumo 15%	l/min	19
Consumo 15%	cfm	0.7
Comprimento	mm	161
Peso	kg	1.3



Quadra		1/2"
Parafuso (capacidade)	mm	M16
Velocidade	rpm	6.800
Torque Max (3 posições)	Nm	258/461/930
Torque Max (3 posições)	ft-lb	190/340/685
Torque Max (inversão)	Nm	960
Torque Max (inversão)	ft-lb	708
Mecanismo de Martelo	tipo	duplo
Ruido *	dB	96.0
Vibração **	m/s ²	3.60
Mangueira (tamanho min.)	pol.	3/8"
Encaixe	pol.	1/4"
Consumo 100%	l/min	144
Consumo 100%	cfm	5.1
Consumo 15%	l/min	22
Consumo 15%	cfm	0.8
Comprimento	mm	186
Peso	kg	2.0

Quadra		3/4"
Parafuso (capacidade)	mm	M32
Velocidade	rpm	6
Torque Max (3 posições)	Nm	1,084/1,300/1,790
Torque Max (3 posições)	ft-lb	800/960/1,320
Torque Max (inversão)	Nm	1,83
Torque Max (inversão)	ft-lb	1,349
Mecanismo de Martelo	tipo	duplo
Ruido *	dB	100.1
Vibração **	m/s ²	18.71
Mangueira (tamanho min.)	pol.	1/2"
Encaixe	pol.	3/8"
Consumo 100%	l/min	195
Consumo 100%	cfm	6.9
Consumo 15%	l/min	29
Consumo 15%	cfm	1.0
Comprimento	mm	218.8
Peso	kg	3.5



AR-WM12M | € 200,00

Chave de impacto 1/2" reversível **compacta** e leve, ideal para uso em espaços confinados. Capacidade de torque extra alto considerando o seu tamanho e peso, mecanismo de embraiagem "Jumbo". Com três posições de aperto. Carcaça em material extra leve com isolamento acustico. Botão de avançar / retroceder para operação com uma mão. Cabo ergonómico para melhor aderência e isolamento de vibração e ar frio.



Quadra		1/2"
Parafuso (capacidade)	mm	M16
Velocidade	rpm	8
Torque Max (3 posições)	Nm	285/380/680
Torque Max (3 posições)	ft-lb	210/280/501
Torque Max (inversão)	Nm	770
Torque Max (inversão)	ft-lb	568
Mecanismo de Martelo	tipo	jumbo
Ruido *	dB	102.0
Vibração **	m/s ²	7.50
Mangueira (tamanho min.)	pol.	3/8"
Encaixe	pol.	1/4"
Consumo 100%	l/min	121
Consumo 100%	cfm	4.23
Consumo 15%	l/min	18
Consumo 15%	cfm	0.6
Comprimento	mm	113
Peso	kg	1.3

AR-WM11S | € 1.12000

Chave de impacto 1" reversível, robusta e potente, ideal para oficinas. Acção de alto torque com quatro posições de aperto. Carcaça em material extremamente leve com isolamento acustico. Mecanismo de martelo duplo para maior torque, maior fiabilidade e vibração reduzida. Botão de avançar / retroceder para operação com uma mão. Cabo ergonómico para melhor aderência e isolamento de vibração e ar frio.



Quadra		1"
Parafuso (capacidade)	mm	M36
Velocidade	rpm	5,5
Torque Max (3 posições)	Nm	976/1300/1735/2712
Torque Max (3 posições)	ft-lb	720/960/1280/2000
Torque Max (inversão)	Nm	2,73
Torque Max (inversão)	ft-lb	2,013
Mecanismo de Martelo	tipo	duplo
Ruido *	dB	104.5
Vibração **	m/s ²	12.88
Mangueira (tamanho min.)	pol.	3/4"
Encaixe	pol.	1/2"
Consumo 100%	l/min	271
Consumo 100%	cfm	9.6
Consumo 15%	l/min	41
Consumo 15%	cfm	1.4
Comprimento	mm	504.5
Peso	kg	8.1



ARR-M38 3/8" | € 115,00

ARR-12 1/2" | € 115,00

Roquete de impacto reversível, robusto e potente, ideal para trabalhar em áreas confinadas. Cabo ergonómico para melhor aderência e isolamento de vibração e ar frio.

Quadra		3/8"
Parafuso (capacidade)	mm	M10
Velocidade	rpm	220
Torque Max	Nm	41
Torque Max	ft-lb	30
Ruido *	dB	88.1
Vibração **	m/s ²	9.71
Mangueira (tamanho min.)	pol.	3/8"
Encaixe	pol.	1/4"
Consumo 100%	l/min	90.6
Consumo 100%	cfm	3.2
Consumo 15%	l/min	14
Consumo 15%	cfm	0.5
Comprimento	mm	173.9
Peso	kg	0.6

Quadra		1/2"
Parafuso (capacidade)	mm	M13
Velocidade	rpm	160
Torque Max	Nm	95
Torque Max	ft-lb	70
Ruido *	dB	91.6
Vibração **	m/s ²	6.00
Mangueira (tamanho min.)	pol.	3/8"
Encaixe	pol.	1/4"
Consumo 100%	l/min	113.2
Consumo 100%	cfm	4
Consumo 15%	l/min	17
Consumo 15%	cfm	0.6
Comprimento	mm	277
Peso	kg	1.3



ARD-10 10mm | € 122,00

ARD-13 13mm | € 186,00

Berbequim pneumático. Simples de usar com uma alavanca de controle de direção junto ao polegar, bucha de aperto rápido. Cabo ergonómico para melhor aderência e isolamento de vibração e ar frio.

Bucha	mm	10
Velocidade	rpm	1,8
Mangueira (tamanho min.)	pol.	3/8"
Encaixe	pol.	1/4"
Ruido *	dB	87.6
Vibração **	m/s ²	2.73
Consumo 100%	l/min	121.4
Consumo 100%	cfm	4.3
Consumo 15%	l/min	18
Consumo 15%	cfm	0.7
Comprimento	mm	206.2
Peso	kg	1.2

Bucha	mm	13
Velocidade	rpm	450
Mangueira (tamanho min.)	pol.	3/8"
Encaixe	pol.	1/4"
Ruido *	dB	88.8
Vibração **	m/s ²	1.93
Consumo 100%	l/min	140
Consumo 100%	cfm	5
Consumo 15%	l/min	21
Consumo 15%	cfm	0.8
Comprimento	mm	249.5
Peso	kg	1.9



AR-S01 | € 250,00

Serra pneumática robusta e potente, adequada para cortar uma variedade de materiais, como metais, plástico, madeira, etc. com um suporte de lâmina ajustável para uso com lâminas de comprimento diferente. Um gatilho de metal com mecanismo de segurança. Entrada de ar giratória, cabo ergonómico para melhor aderência e isolamento de vibração e ar frio.

AR-S02 | € 220,00

Serra pneumática robusta e potente, adequada para cortar uma variedade de materiais, como metais, plástico, madeira, etc. com um suporte de lâmina ajustável para uso com lâminas de comprimento diferente. Um gatilho de metal com mecanismo de segurança. Cabo ergonómico para melhor aderência e isolamento de vibração e ar frio.

Curso	mm	10
Cursos por minuto	Bpm	9000
Cap. Corte - Aço	mm	3.0
Cap. Corte - Alumínio	mm	3.4
Cap. Corte - Madeira	mm	4.0
Ruído *	dB	83.6
Vibração **	m/s ²	<2.4
Mangueira (tamanho min.)	pol.	3/8"
Encaixe	pol.	1/4"
Consumo 100%	l/min	31
Consumo 100%	cfm	1.08
Consumo 15%	l/min	4.7
Consumo 15%	cfm	0.2
Comprimento	mm	245.1
Peso	kg	0.7

Curso	mm	10
Cursos por minuto	bpm	9000
Cap. Corte - Aço	mm	3.0
Cap. Corte - Alumínio	mm	3.4
Cap. Corte - Madeira	mm	4.0
Ruído *	dB	84.4
Vibração **	m/s ²	5.26
Mangueira (tamanho min.)	pol.	3/8"
Encaixe	pol.	1/4"
Consumo 100%	l/min	22.94
Consumo 100%	cfm	0.81
Consumo 40%	l/min	9.18
Consumo 40%	cfm	0.32
Comprimento	mm	170
Peso	kg	0.45



AR-G01 | € 95,00

Rectificadora pneumática, com cabo ergonómico para melhor aderência e isolamento de vibração e ar frio, saída de ar com silenciador, gatilho com mecanismo de segurança.



Ângulo		recto
Pinça	mm	6
Velocidade	rpm	25
Ruído *	dB	81.78
Vibração **	m/s ²	5.42
Mangueira (tamanho min.)	pol.	3/8"
Encaixe	pol.	1/4"
Consumo 100%	l/min	113
Consumo 100%	cfm	16.9
Consumo 15%	l/min	4.0
Consumo 15%	cfm	0.6
Comprimento	mm	161
Peso	g	400



AR-G02 | € 115,00

Rectificadora pneumática angular, para uso a 90°, com cabo ergonómico para melhor aderência e isolamento de vibração e ar frio, saída de ar com silenciador, gatilho com mecanismo de segurança.

Ângulo		90°
Pinça	mm	6
Velocidade	rpm	25
Ruído *	dB	81.78
Vibração **	m/s ²	5.42
Mangueira (tamanho min.)	pol.	3/8"
Encaixe	pol.	1/4"
Consumo 100%	l/min	113
Consumo 100%	cfm	16.9
Consumo 15%	l/min	4.0
Consumo 15%	cfm	0.6
Comprimento	mm	165
Peso	g	400



AR-BS10 | € 310,00

Lixadora pneumática de cinta, com braço flexível 360°. Aceita cintas com 6mm a 10mm de largura. Para lixar metal, plástico ou madeira.

Cintas de lixa (capacidade)	mm	6 x 330, 10 x 330
Velocidade	rpm	20000
Ruído *	dB	85.5
Vibração **	m/s ²	0.66
Mangueira (tamanho min.)	pol.	3/8"
Encaixe	pol.	1/4"
Consumo 100%	l/min	119
Consumo 100%	cfm	4.2
Consumo 50%	l/min	59.5
Consumo 50%	cfm	2.1
Comprimento	mm	331
Peso	kg	0.85



345



AR-AG125 | € 255,00

Rebarbadora pneumática, capacidade de disco 5" (125mm). Pega lateral com amortecedor de vibrações, gatilho tipo alavanca com sistema de segurança e admissão de ar giratória.



Disco (capacidade)	mm	125 x 22
Porca	mm	M14
Velocidade	rpm	12000
Ruído *	dB	90.2
Vibração **	m/s ²	5.7
Mangueira (tamanho min.)	pol.	3/8"
Encaixe	pol.	1/4"
Consumo 100%	l/min	113
Consumo 100%	cfm	4
Consumo 50%	l/min	56.5
Consumo 50%	cfm	2
Potência	W	670
Peso	kg	2

AR-C80 | € 156,00

Rebarbadora de corte vertical, direcção reversível. Punho com isolamento de vibrações e ar frio, gatilho tipo alavanca com sistema de segurança..



Disco (capacidade)	mm	76 x 10
Velocidade	rpm	18000
Ruído *	dB	97.6
Vibração **	m/s ²	2.3
Mangueira (tamanho min.)	pol.	3/8"
Encaixe	pol.	1/4"
Consumo 100%	l/min	113
Consumo 100%	cfm	4
Consumo 40%	l/min	45
Consumo 40%	cfm	1.6
Peso	kg	0.9

AR-RG80 | € 231,00

Pistola de rebitar pneumática, para usar com rebites de alumínio, aço ou aço inoxidável de 2.4, 3.0, 4.0, 4.8 e 5.0mm.



Força	N	9000
Porca	mm	M14
Velocidade	rpm	12000
Ruído *	dB	85.5
Vibração **	m/s ²	2.5
Mangueira (tamanho min.)	pol.	3/8"
Encaixe	pol.	1/4"
Temperatura de utilização	°C	0 - 40
Consumo 100%	l/rebite	2.1
Peso	g	1710



AR-N12 | € 111,00

Agulha desencrostadora pneumática, para limpar e desencrostar. Com design simples, gatilho tipo alavanca. Para usar com agulhas de 3mm de diâmetro e 126mm de comprimento.



Velocidade	bpm	4000
Nº de agulhas	pcs	12
Agulha Ø x comprimento	mm	3 x 126
Ruído *	dB	88.7
Vibração **	m/s ²	3.8
Mangueira (tamanho min.)	pol.	3/8"
Encaixe	pol.	1/4"
Consumo 100%	l/min	170
Consumo 100%	cfm	6
Consumo 20%	l/min	34
Consumo 20%	cfm	1.2
Comprimento	mm	310
Peso	kg	1.14

* Testes de medição de ruído de acordo com EN ISO 15744

** Testes de medição de vibração de acordo com EN ISO 28927-2



Pistolas de Ar

Pistolas de ar com punho ergonómico. Adequadas para uso com a mão esquerda ou direita. Inserto de rosca metálica para maior compatibilidade e um orifício para pendurar quando não estiver em uso.



nºStock		AR-B01	AR-B02
Comprimento Bico	mm	100	270
Encaixe		1/4"	1/4"
Comprimento Bico	mm	212	360
Peso	g	106	130
Preço		€ 9,00	€ 9,70

Pistola de Ar OSHA

Pistola de ar de acordo com a normas de segurança OSHA.-



nºStock		ARB03
Comprimento Bico	mm	100
Encaixe		1/4"
Comprimento Bico	mm	212
Peso	g	160
Preço		€ 10,50



AR-EP25 | € 115,00

Gravador pneumático, adequado para uso em plásticos e metais. Inclui cabo de ligação de 1,5 metros, com entrada de ar rotativa.

Pressão	bar	6.2
Velocidade	bpm	13000
Ruído *	dB	78
Vibração **	m/s ²	2.5
Encaixe	pol.	1/4"
Consumo 100%	l/min	30
Consumo 100%	cfm	1.1
Consumo 50%	l/min	15
Consumo 50%	cfm	0.6
Peso	kg	0.22



CAL-D-150 | € 67,00

Paquímetro digital de 150 mm com boca de 40 mm. Leitura mm e polegadas, botão de reset, escala de 0,01mm, leitor com dígitos de 8 mm de altura, desligamento automático e trava de parafuso. Zero definido em qualquer posição. DIN862. Utiliza pilhas CR2032 (fornecidas).



Capacidade	mm	150
Boca	mm	40
Dígitos	mm	8
Precisão	mm	0.01

CAL-V-150 | € 51,00

Paquímetro de 150 mm com boca de 38 mm. Leitura em mm e em polegadas com escala cromada fosca para facilitar leitura passo de 0,05 mm. Em aço inoxidável, fornecido em caixa de armazenamento de plástico. DIN862.



Capacidade	mm	150
Boca	mm	40

MIR-25 | € 56,00

Micrómetro com capacidade de 0 a 25 mm com leitura de 0,01 mm com precisão de 0,004 mm. Aço temperado com superfícies de medição polidas, estrutura forjada e escala cromada mate para facilitar a leitura. Fornecido com um estojo de armazenamento de plástico. DIN863.



Capacidade	mm	0-25
Escala	mm	0.01
Precisão	mm	0.004

DG-MM | € 128,00

Comparador completo com suporte magnético. Comparador em alumínio, capacidade de 10 mm, escala de 0,01 mm, mostrador de 58 mm de diâmetro com escala giratória e duas tolerâncias. Um ponteiro extra indica milímetros inteiros e a ponta é substituível. O suporte possui um ajuste de altura máxima de 330 mm, que cobre a maioria dos usos. Um forte ímã na base pode ser ligado ou desligado ao pressionar um botão e um o botão de travamento central aperta ou liberta as articulações inferior, superior e intermédia com ajuste adicional no suporte superior.



Capacidade	mm	0-25
Escala	mm	0.01
Altura max.	mm	330
Base (comprimento)	mm	55
Base (largura)	mm	50
Base (altura)	mm	58
Peso	kg	1.625



Fitas Métricas

Fitas métricas ABS, com travão e clip de bolso. Classe II.

nºStock	Comp. mm	Largura mm	Preço
MT-03-MM	3	13	€ 6,30
MT-05-MM	5	19	€ 9,50
MT-08-MM	8	25	€ 18,60



Fitas Métricas Longas

Fitas métricas longas, com gancho retráctil e fita em nylon. Corpo em ABS anti-choque, clip de bolso. Classe II.

nºStock	Comp. mm	Largura mm	Preço
MT-10	10	10	€ 24,10
MT-15	15	10	€ 26,30
MT-30	30	10	€ 29,80



Fitas Métricas Longo Alcance

Fitas métricas longo alcance, fita em nylon. Corpo em ABS anti-choque, pega ergonómica. Classe II.

nºStock	Comp. mm	Largura mm	Preço
MTS-30	30	12.7	€ 42,80
MTS-50	50	12.7	€ 65,00



Esquadro de Carpinteiro - Base Alumínio

Esquadros de carpinteiro com base em alumínio, lâmina em aço inoxidável. A lâmina mede 1.5 x 45 mm e a base tem uma espessura de 18 mm superfície de trabalho fresada. Precisão de medição de 0,03 °.



nºStock	Lâmina mm	Precisão mm	Peso g	Preço
SQA-A200	200	±0.03°	240	€ 22,50
SQA-A250	250	±0.03°	275	€ 23,80
SQA-A300	300	±0.03°	300	€ 26,00

Esquadro de Carpinteiro - Base Plástico

Esquadros de carpinteiro com base em fibra, lâmina em aço inoxidável. A lâmina mede 1.0 x 45 mm e a base tem uma espessura de 18 mm superfície de trabalho fresada. Precisão de medição de 0,06 °.



nºStock	Lâmina mm	Precisão mm	Peso g	Preço
SQA-P250	250	±0.06°	150	€ 11,80
SQA-P300	300	±0.06°	160	€ 12,90

Esquadros com Base

Esquadros com base em zincada, precisão de nível 3.



nºStock	Comprimento mm	Comprimento mm	Preço
SQAB-10070	100	70	€ 17,50
SQAB-150100	150	100	€ 24,20
SQAB-200130	200	130	€ 36,00
SQAB-300175	300	175	€ 72,00

SQA-090 | € 29,00

Esquadro simples em aço, com corpo uniforme (25 x 6mm). Lado longo 150mm, curto 100mm. Rectificado e polido. DIN 875/2.



SQ-AC-300 | € 133,50

Esquadro combinado. Graduado em mm e polegadas, inclui régua de aço de 300 mm com transferidor reversível, borda angular e cabeça central. A borda angular e o transferidor incluem um nível de bolha como uma função extra.



SLA-040 | € 12,90

Nível em alumínio de 400mm, 3 bolhas, Precisão 1.0mm/m.

**Níveis Profissionais - 2 Bolhas**

Níveis profissionais com perfil 24 x 50mm em alumínio, bolha resistente a raios UV e electricidade estática. Precisão 0.5mm/m e 0.75mm/m (invertido).



nºStock	Comprimento mm	Largura mm	Altura mm	Precisão	Precisão invertido	Peso g	Preço
SLA-0300	300	24	50	±0.5mm/m	±0.75mm/m	210	€ 16,50
SLA-0400	400	24	50	±0.5mm/m	±0.75mm/m	280	€ 18,80
SLA-0600	600	24	50	±0.5mm/m	±0.75mm/m	420	€ 21,20
SLA-1000	1000	24	50	±0.5mm/m	±0.75mm/m	690	€ 38,80
SLA-1200	1200	24	50	±0.5mm/m	±0.75mm/m	840	€ 42,30
SLA-1500	1500	24	50	±0.5mm/m	±0.75mm/m	1,05	€ 44,80
SLA-1800	1800	24	50	±0.5mm/m	±0.75mm/m	1,26	€ 51,00
SLA-2000	2000	24	50	±0.5mm/m	±0.75mm/m	1,4	€ 53,00

Níveis Profissionais Magnéticos - 2 Bolhas

Níveis profissionais magnético com perfil 24 x 50mm em alumínio, bolha resistente a raios UV e electricidade estática. Precisão 0.5mm/m e 0.75mm/m (invertido).



nºStock	Comprimento mm	Largura mm	Altura mm	Precisão	Precisão invertido	Peso g	Preço
SLM-0300	300	24	50	±0.75mm/m	±0.75mm/m	240	€ 53,80
SLM-0400	400	24	50	±0.75mm/m	±0.75mm/m	310	€ 55,30
SLM-0600	600	24	50	±0.75mm/m	±0.75mm/m	450	€ 62,80
SLM-1000	1000	24	50	±0.75mm/m	±0.75mm/m	750	€ 77,50
SLM-1200	1200	24	50	±0.75mm/m	±0.75mm/m	900	€ 96,80



Nível Torpedo Magnético

Nível torpedo magnético com perfil em alumínio preto 230mm. Bolha resistente a raios UV e electricidade estática. Precisão 1.0mm/m.



nºStock	Comp. mm	Largura mm	Altura mm	Precisão	Peso g	Preço
SLT-01	230	16	38	±1.0mm/m	190	€ 23,80

Nível Torpedo Magnético

Nível torpedo magnético com perfil em plástico ABS 230mm. Bolha resistente a raios UV e electricidade estática. Precisão 1.5mm/m.



nºStock	Comp. mm	Largura mm	Altura mm	Precisão	Peso g	Preço
SLT-02	230	16	40	±1.5mm/m	160	€ 9,75

Réguas Metálicas

Réguas metálicas com graduação em mm e polegadas (régua 150mm, graduação só em mm).



nºStock	Comp. mm	Larg. x Esp. mm	Preço
ST-150	150	20 x 0.8	€ 5,90
ST-200	200	20 x 0.8	€ 6,00

AB-200 | € 6,00

Suta 200 mm. Dimensões 200 x 23 x 25mm, peso 100g.



DM-550 | € 46,00

Multímetro digital. Lê tensão, corrente, resistência e temperatura e inclui um testador de diodo e testador de continuidade. Retenção de medições, ecrã com luz preta e dígitos de 13 mm. CAT II 250 volts, EN 61010, EN61326. Fornecido com condutores. Usa duas pilhas de 1.5 volts tipo AAA (incluídas).

Voltagem DC	Volts	200-2000mV - 20-200-250V
Voltagem AC	Volts	200-250V
Corrente DC	Amperes	2000µA – 20-200mA-10A
Resistência	Ohms	200-2000Ω - 20-200KΩ - 20MΩ
Temperatura	° Celsius	-40 to +1,000°C





PORTUGAL



TENGTTOOLS®

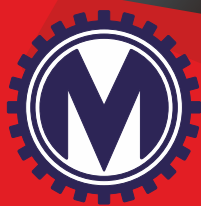

**MONTENEGRO,
FERNANDES & C.ª, S. A.**

Avenida Associação Industrial e
Comercial de Gondomar, 250/270
4514-909 Fânzeres - Gondomar
Portugal

Telefone: +351 224 664 540
(chamada para a rede fixa nacional)

comercial@montenegrofernandes.pt
www.montenegrofernandes.pt



Catálogo 2024